

Water-air heat pump

# VERSATEMP

EVH-X SPACE 2.1-12.1 RANGE

TECHNICAL BULLETIN



SIZE	2.1	3.1	5.1	7.1	10.1	12.1
COOLING CAPACITY kW	4,81	8,46	11,2	17,9	25,9	30,8
HEATING CAPACITY kW	7,06	9,83	13,5	22,1	32,3	36,4

## Pagina

3	Feature and benefits
6	Standard unit technical specifications
7	Accessories supplied separately
13	General technical data
21	Option compatibility
22	Dimensional drawings

# Feature and benefits

## EVH-X SPACE - The compact and silent solution for commercial applications

Versatemp EVH-X SPACE is the high efficiency packaged air-conditioner that automatically heats or cools spaces throughout the whole year, using water as source.

It's the ideal solution when there are the necessity to install the false ceiling unit or for its maximum integration within furnishings. Furthermore, it contains only a minimum quantity of ecological refrigerant (less than 3 kg), and is therefore not subject to restrictions on use. The two water supply ducts do not have length limitations, even, in many cases, they do not need to be insulated and result easy to install and maintain.

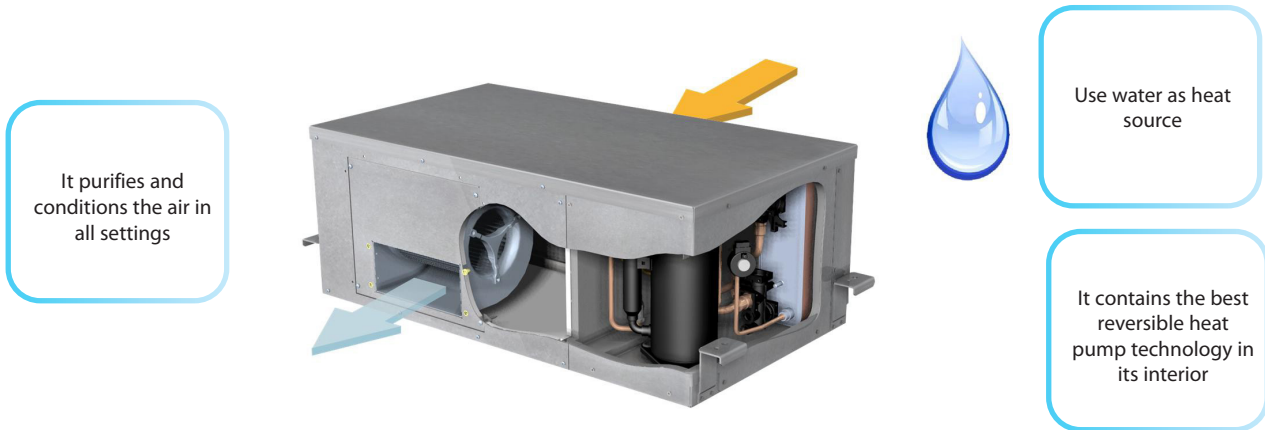

### System simplification

Thanks to its one-piece construction, the system components are within the unit itself.  
The heat or cooling energy which is generated by the unit is directly transferred into the served ambient.  
The supply water may come from an energy transfer WLHP loop circuit, from a natural source such as a groundwater, or even from water works in certain cases where architectural constraints make any other system solution impossible.

### Silence and reduction of management costs

Thanks to the numerous construction solutions which have been adopted and to its special automatic control, vibrations and sound emissions are undoubtedly reduced.

The reversible heat pump technology at high energy efficiency maintains the required comfort only where and when it is needed, reducing the consumption and therefore the management costs over the entire annual cycle.

In all the applications which allow it, the devices which limit water consumption reduce these expenses even further.

### The perfect solution for the system retrofit

Different versions are available and are compatible with Versatemp products of the EVH SPACE and CH series, as far as regards capacities, sizes and water connections. EVH-X SPACE is therefore the ideal solution for the retrofit of the existing systems and their possible completion or enlargement.

The fan can be adjusted for air delivery in line or with angle at 90°.

### High Efficiency all year round

EVH-X SPACE increases the overall system cost thanks to technological solutions from the inside, all choices for efficient operation and long-lasting. Reliability is guaranteed by strict quality controls in the construction phase and rigorous testing functional on the finished product.

- High efficiency rotary compressor
- Mechanical expansion valve
- Source side plate exchanger
- Multi-speed fan
- Control electronics integrated in the unit

# Feature and benefits

## Easy to use in the small and large plants

EVH-X SPACE is extremely versatile and reliable even in solutions controlled by the User.

### Standard automatic functions

The standard EVH-X SPACE version is equipped with a standard automatic control, complete with a micro processor card and control and safety sensors built-in. Given that it is without a user display, this version represents an efficient solution in all applications open to the public where the operating parameters could otherwise be inappropriately changed.

The standard automatic control:

- it detects the space conditions and compares them with the user set point;
- it can decide the operating mode automatically (heating or cooling);
- it decides the activation of resources and can automatically select the fan speed depending on the distance from the scheduled set point;
- it can manage without further accessories a mini local network of 15 units, one of which is a master and the others slaves which replicate its operating.

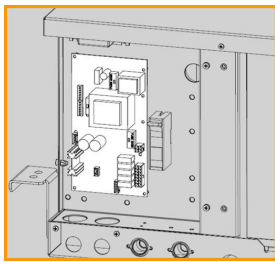

### Voltage-free contact user interface

The standard version has a series of voltage-free contacts, or rather contacts without tension, for managing the following functions remotely:

- switching on and switching off;
- changing function mode (heating or cooling);
- setting the Set point (standard or economic);
- cumulative alarm.

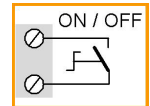

### User interface by serial connection (optional)

The various communication protocols allow the unit to exchange information with the main supervision systems by means of serial connections.



### User interface with wall display (optional)

The control can be cased or uncased. It has a modern aspect and is very simple to use even for non-specialised users. Furthermore, it has different access levels, password protected, available for managing the different unit functions.

Among the main functions, it detects the temperature using the temperature sensor in its interior, schedules the operating time bands, displays and manages the operating alarms and parameters, enables the manual management of the fan speed and operating mode (heating or cooling).



#### USER INTERFACE INSTALLATION

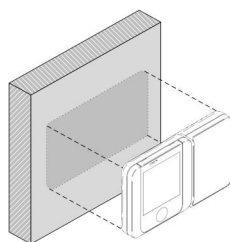

on the wall

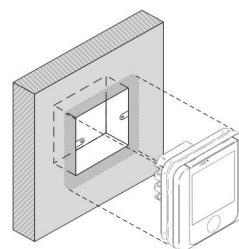

in an uncased box

# Feature and benefits

## Easy to connect to the water network

System components for connecting EVH-X SPACE to water circuit are available as accessories and are already sized to ensure the proper operating and efficiency of the unit.

The assembly of hydraulic valves and cock outside the unit allows their place in a easily accessible position of the ceiling for routine maintenance.

Further components which are needed for connecting the hydraulic supply network are available as accessories (installation encharged to the Client).

- steel mesh strainer;
- ON/OFF motorised 2-way valve for variable flow-rate system;
- motorised 2-way modulating valve for system with disposable water;
- hand shut-off valves constant flow-rate loop system;
- hand by-pass valve for system cleaning;
- water balancing valve;
- water control flow switch

The unit is complete with plate heat exchanger and control and safety devices.

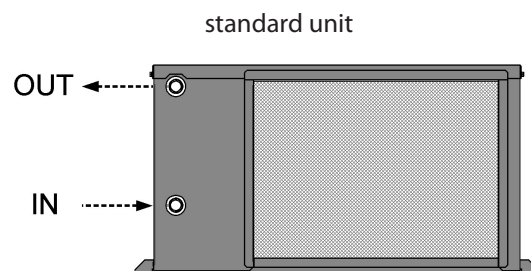

## The versatility in different application systems

The integration of the unit with the optional hydraulic components makes it easier to start and run the system operation in the different installations: constant or variable flow-rate loop.

The pipe work arrangements enable the unit to be intercepted from the system, the system cleaning (fluxing), the water mechanical filtration during the ordinary operating to protect the exchanger from fouling.

The 2-way modulating valve, available as accessory, allows to:

- further extend the application range to systems fed with groundwater or aqueduct. It is so possible to reduce the water consumption;
- extend the standard unit operating range in cooling mode with source at low water temperature;
- maximize the efficiency in heating mode also with source at high water temperature.

In the presence of the 2-way modulating valve, the water feeding must be at variable flow-rate.

This allows an interesting energy saving on the installation and then a further reduction of the management costs.

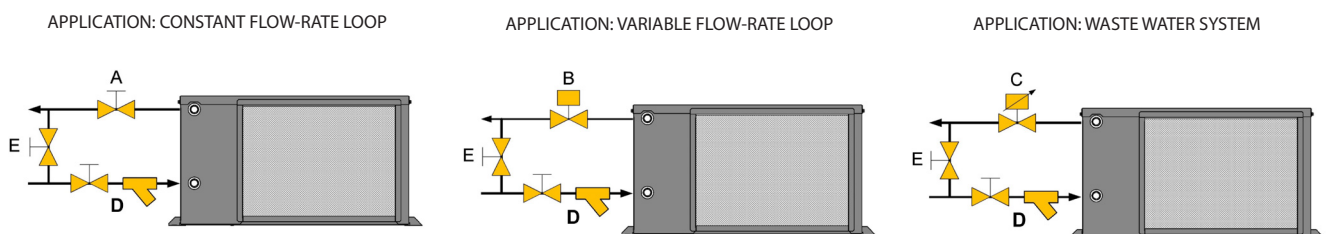

- A - Hand shut-off valve
- B - ON/OFF motorised 2-way valve
- C - Modulating 2-way motorised valve
- D - Steel mesh strainer and hand shut-off valve
- E - Hand by-pass valve

# Standard unit technical specifications

## Compressor

**Size 2.1 - 3.1 - 5.1.** Hermetic rotary compressor with gas compression in the crankcase, direct suction, no oil heater. It is mounted on antivibration rubber pads. Includes oil feed.

**Size 7.1 - 10.1 - 12.1.** Hermetic orbiting scroll compressor complete with motor over-temperature and over-current devices and protection against excessive gas discharge temperature. Fitted on rubber antivibration mounts and complete with oil charge.

## Structure

Structure made entirely in Zinc–Magnesium plate that guarantees excellent mechanical characteristics and high corrosion strength over time. The compressor area is made from thick metal plate and is completely insulated with soundproofing material to minimise noise output. The ventilating section is completely lined with anti-condensate and soundproofing material.

## Internal exchanger

Direct expansion finned exchanger, made of copper pipes in staggered rows and mechanically expanded to the fin collars. The fins are made of aluminium with hydrophilic coating and a corrugated surface and adequately distanced to ensure the maximum heat exchange efficiency.

## External exchanger source side (water)

Direct expansion heat exchanger with braze welded stainless steel INOX AISI 316 plates and complete with external thermal/anti-condensation insulation.

The exchanger is complete with:

- differential pressure switch, water side
- entering water temperature sensor
- leaving water temperature sensor, with antifreeze function

## Fan

Dual intake centrifugal fan, directly coupled, motor with external rotor, located in the centre of the fan in an aerodynamically optimum position and suspended on antivibration dampers. Forward blades for maximum efficiency and low noise, statically- and dynamically-balanced according to the ISO 1940 standards, section 6.3. The scroll, the rotor and the frame are made from galvanized steel plate.

## Refrigeration circuit

Refrigeration circuit with:

- liquid receiver (not available for size 5.1 - 7.1);
- 4-way reverse cycle valve;
- high pressure safety pressure switch,
- low pressure safety pressure switch,
- mechanic thermostatic valve,
- mechanical filter.

## Filtration

Flat filter, made up of a galvanized plate frame with galvanized and electric-welded protective mesh and 100% regenerable polyester filtering media with PVC resin. G2 efficiency according to CEN-EN 779 standard (Eurovent class EU4/5 - average efficiency 79% ASHRAE 52-76 Atm). Self-extinguishing (resistance to fire class 1 - DIN 53438).

## Drain pan

Condensate collection tray made of AISI 304 stainless steel with external anti-condensation insulation and equipped with siphon drain tube. Sensore di livello dell'acqua. Water level sensor. Provide a siphon that, eliminating the negative pressure caused by the fan, prevents the air intake from the discharge duct. Siphon on the condensation drain pipe to be performed by the installer.

## Electrical panel

The electrical panel, consisting of a microprocessor control, is located inside the unit and can be accessed via a panel which can be easily removed.

**The capacity section includes:**

- power input terminals

**The control section includes:**

- microprocessor control;
- self-test system;
- switch on and off daily and weekly programmer and set point;
- cumulative alarms device, potential-free contacts for remote ON-OFF, summer/winter mode change, ECO setpoint setting, water flow presence;
- antifreeze protection on the air side;
- antifreeze protection water side
- no water flow-rate protection with differential pressure switch;
- return air temperature probe with thermoregulation function;
- manual or automatic fan speed selection;
- dirty filters warning timer that periodically alerts to the need for maintenance of the filters.

## Accessories supplied separately

- CIWMX - Electronic room control with display, for wall installation in built-in box
- CWMX - Electronic room control with display, for wall installation.
- V2MANX - 2-way manually actuated valves for constant water flow loop.
- V2ONX - 2-way ON-OFF valve for variable flow-rate loop.
- V2MODX - 2-way modulating valve for disposable water system.
- BPH2OX - Shut-off valve for by-pass (water side).
- FCVBX - Water balancing valve.
- VIFWX - Steel mesh strainer and hand shut-off valve.
- CDPX - Condensate drain pump.
- APFLX - Filter-holder with access from the lower side.
- FLOX - Water control flow switch
- MOBX - Modbus RS485 serial port kit.
- BACX - BACnet serial communication module.
- CMSLWX - LonWorks serial communication module.
- AMMX - Spring antivibration mounts.

# Accessories supplied separately

## CIWMX - Electronic room control with display, for wall installation in the built-in box

Option which allows the remote control of the unit which can be easily installed in the main built-in units which are available on the market with squared or rounded 65 mm diameter / 31 mm deep profiles. The electronic control with display is simple to use even for non-specialised users.

Thanks to the icon menu which is complete with back-lighting, it allows different unit functions to be controlled, including:

- switching the unit on and off;
- reading the temperature directly on the probe in its interior;
- alarm and unit status display;
- password protection to access the unit's parameters;
- changing the manual operating mode (hot or cold) and/or set point;
- programming the daily and weekly time schedule for switching on and off and for setting the standard or economic set point;
- management of the operating parameters;
- language management for the navigation menu;
- manually, or automatically, managing the fan speed, depending on the distance from the set- point.

!! The device is prepared for connection to a unit electrical panel (installation by the Client) with the following modes:

- For a max distance of 10m only use the power supply cable and serial communication included in the pack. In this way electric power is supplied by the unit 24V AC.
- For a max distance of 200m use a shielded twisted pair cable with a min 0.5 / max 1.5 mm<sup>2</sup> section. In this case the 220-240V ~ 50Hz electricity supply is by the Client (transformer integrated in the display).

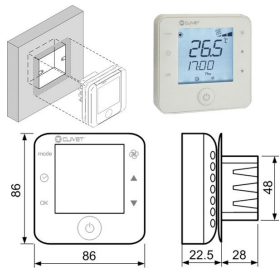

Electrical connection for distances lower than 10m



Electrical connection for distances exceeding 10m



## CWMX - Electronic room control with display for wall installation

An option which enables the unit to be remotely controlled. It can be attached to a wall with the support in a horizontal or vertical position. The electronic control with display is simple to use even for non-specialised users.

It allows different unit functions to be controlled, including:

- switching the unit on and off;
- reading the temperature directly on the probe in its interior;
- alarm and unit status display;
- password protection to access the unit's parameters;
- changing the manual operating mode (hot or cold) and/or set point;
- programming the daily and weekly time schedule for switching on and off and for setting the standard or economic set point;
- management of the operating parameters;
- language management for the navigation menu;
- manually, or automatically, managing the fan speed, depending on the distance from the set- point.

!! The device is prepared for connection to a unit electrical panel (installation by the Client) with the following modes:

- For a max distance of 10m only use the power supply cable and serial communication included in the pack. In this way electric power is supplied by the unit 24V AC.
- For a max distance of 200m use a shielded twisted pair cable with a min 0.5 / max 1.5 mm<sup>2</sup> section. In this case the 220-240V ~ 50Hz electricity supply is by the Client (transformer integrated in the display).

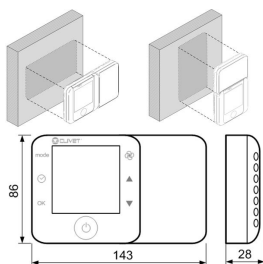

Electrical connection for distances lower than 10m



Electrical connection for distances exceeding 10m





# Accessories supplied separately

## V2MANX - 2-way manually actuated valves for constant water flow loop

Shut-off device which enables the unit to be hydraulically closed for maintenance operations and to prepare the system before connecting the unit. Manual valves are provided for the hydraulic interception of the entire unit.

!! Option to be installed outside the unit on the water outlet pipe of the exchanger. Provide for spaces to assemble/disassemble the valve.



### V2MANX option pressure drops

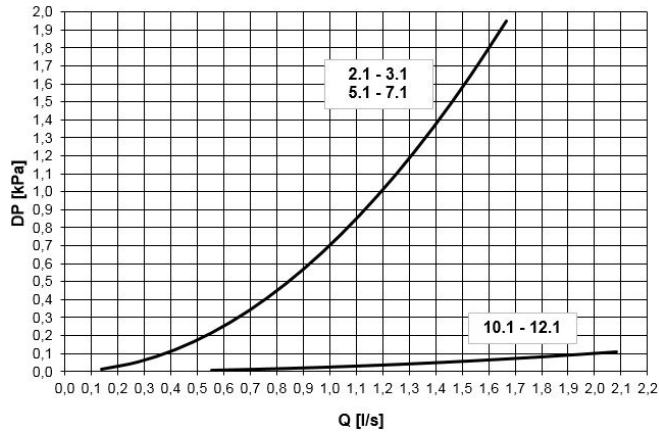

Q = Water flow-rate [l/s]

DP = Water side pressure drops (kPa)

### Water connection diagram

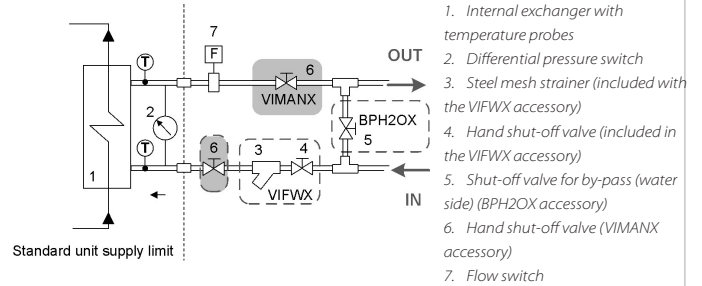

### VIMANX option technical features

Size	2.1 - 3.1	5.1 - 7.1	10.1 - 12.1
Water fitting diameter	1"	1"	1 1/2"
System side water fittings	FEMALE	FEMALE	FEMALE
Unit side water fittings	FEMALE	FEMALE	FEMALE
Maximum operating pressure	10bar	10bar	10bar
Flow rate coefficient (Kvs)	26	26	31

## V2ONX - 2-way ON/OFF valve for variable flow-rate loop

Option recommended for applications with a variable water flow-rate loop. It includes an ON/OFF motorised 2-way valve located at the outlet of the exchanger on the water side, powered and controlled by the unit. It operates in conjunction with the cooling circuit: when the compressor is stationary, the valve remains closed, thereby reducing water consumption.

!! Option to be installed outside the unit on the water outlet pipe of the exchanger. Provide for spaces to assemble/disassemble the valve.

!! With this option the unit is provided full of rapid electric connections for the valve feeding and automatic control.



### Pressure drops of the V2ONX option

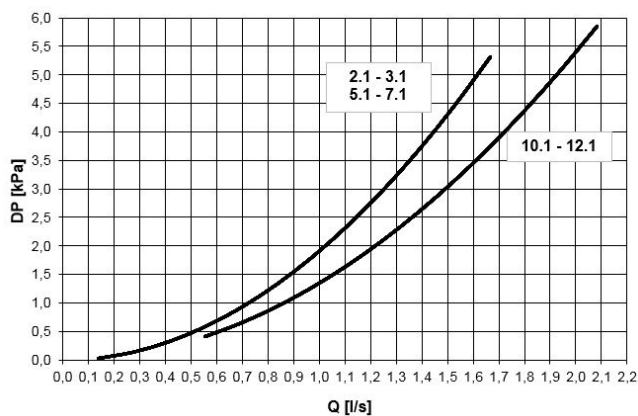

Q = Water flow-rate [l/s]

DP = Water side pressure drops (kPa)

### Water connection diagram

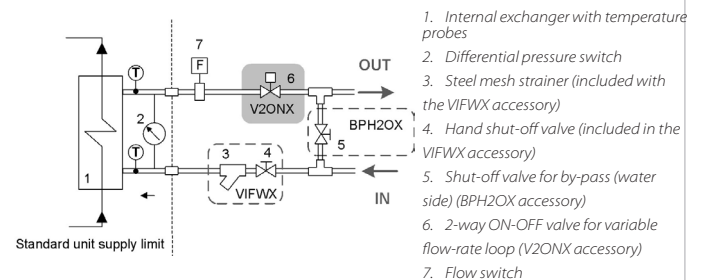

### V2ONX option technical features

Size	2.1 - 3.1	5.1 - 7.1	10.1 - 12.1
Water fitting diameter	1"	1"	1 1/2"
System side water fittings	FEMALE	FEMALE	FEMALE
Unit side water fittings	MALE	MALE	MALE
Maximum operating pressure	10bar	10bar	10bar
Flow rate coefficient (Kvs)	26	26	156



# Accessories supplied separately

## V2MODX - 2-way modulating valve for disposable water system

Option indicated in the applications with disposable water at a temperature relatively low (groundwater) or with a variable flow-rate loop where the unit must operate in heating with high water temperatures or in cooling with low water temperatures. The 2-way motorised valve, modulating type, is placed in the exchanger output water side and is fed by the unit. Its operating is combined with that of the refrigerant circuit: the modulation by 0-10V signal according to the refrigerant pressure in the exchanger source side, reduces the water consumption and maintains the unit in the provided operating range both in cooling and in heating mode.



!! Option to be installed outside the unit on the water outlet pipe of the exchanger. Provide for spaces to assemble/disassemble the valve.

!! With this option the unit is provided full of rapid electric connections for the valve feeding and automatic control.

### V2MODX option pressure drops

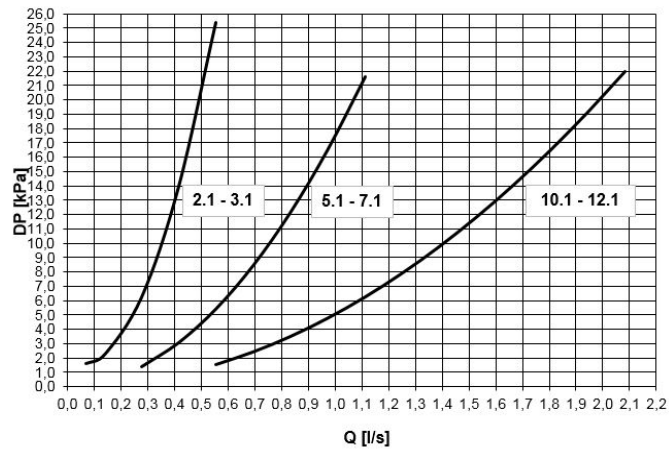

Q = Water flow-rate[l/s]  
DP = Water side pressure drops (kPa)

### Water connection diagram

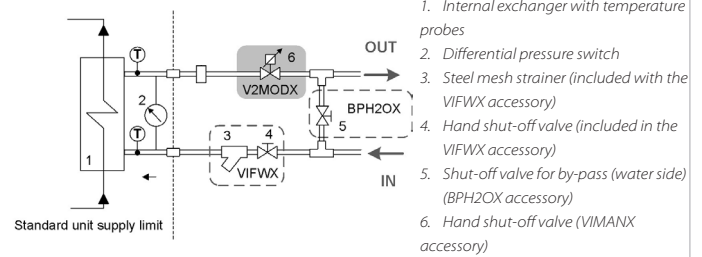

1. Internal exchanger with temperature probes
2. Differential pressure switch
3. Steel mesh strainer (included with the VIFWX accessory)
4. Hand shut-off valve (included in the VIFWX accessory)
5. Shut-off valve for by-pass (water side) (BPH2OX accessory)
6. Hand shut-off valve (VIMANX accessory)

### V2MODX option technical features

Size	2.1 - 3.1	5.1 - 7.1	10.1 - 12.1
Water fitting diameter	3/4"	3/4"	1"
System side water fittings	FEMALE	FEMALE	FEMALE
Unit side water fittings	FEMALE	FEMALE	FEMALE
Maximum operating pressure	10bar	10bar	10bar
Flow rate coefficient (Kvs)	4	8,6	16

## BPH2OX – Shut-off valve for by-pass (water side)

The device allows the exchanger by-pass inside the unit for the cleaning operations (flowing) the water circuit. This allows to prevent the exchanger from getting dirty. It consists of a 2-way hand valve.

!! Option to be installed outside the unit on the water outlet pipe of the exchanger. Provide for spaces to assemble/disassemble the valve.



### BPH2OX option technical features

Size	2.1 - 3.1	5.1 - 7.1	10.1 - 12.1
Water fitting diameter	1"	1"	1 1/2"
System side water fittings	FEMALE	FEMALE	FEMALE
Unit side water fittings	MALE	MALE	MALE
Maximum operating pressure	10bar	10bar	10bar
Flow rate coefficient (Kvs)	26	26	156

### Water connection diagram

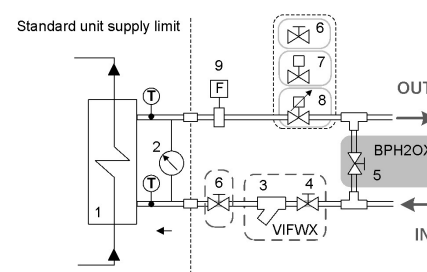

1. Internal exchanger with temperature probes
2. Differential pressure switch
3. Steel mesh strainer (included with the VIFWX accessory)
4. Hand shut-off valve (included in the VIFWX accessory)
5. Shut-off valve for by-pass (water side) (BPH2OX accessory)
- 6-7-8. Regulating / shut-off valves for the system (see the VIMANX, V2MODX and V2ONX accessories)
9. Flow switch

# Accessories supplied separately

## FCVBX - Water balancing valve

The device enables the water flow through the unit to be calibrated without measuring tables or devices. In this way it is possible to balance the water flow in the circuit. The special viewer enables instantaneous reading of the water flow (in litres / minute). The calibration can be easily carried out even by non-specialised operators, operating on the special control screws. It includes adaptors for varying the diameter between the balancing valve and the water fittings.

### Features of the manual balancing valve

Size	2.1 - 3.1	5.1 - 7.1	10.1 - 12.1
Balancing valve diameter	1"	1"	1 1/2"
Water fitting diameter	1"	1"	1 1/2"
System side water fittings	MALE	MALE	MALE
Unit side water fittings	MALE	MALE	MALE
Max. operating pressure	10bar	10bar	10
Field flow control	0,17 - 0,67 l/s	0,33 - 1,50 l/s	0,5 - 2,0 l/s
Flow rate coefficient (Kvs)	5	17	30



The water side pressure drop can be determined with the following formula:

$$Dp \text{ [bar]} = \left( \frac{3.6 \times Q \text{ [l/s]}}{Kvs} \right)^2$$

Q = Water flow-rate[l/s]

Dp = Water side pressure drops (bar)

Kvs = Flow rate coefficient [m<sup>3</sup>/h]

## VIFWX - Steel mesh strainer and hand shut-off valve

The device protects the plate exchanger from any impurities inside the water circuit. The stainless steel mesh mechanical strainer must be placed on the water inlet line. It can be easily removed for periodical maintenance and cleaning operations. It also includes the hand two-way shut-off valve located on the inlet line and required for periodical maintenance operations.

!! Hydraulic connection performed by Customer. Provide for spaces to assemble/disassemble the components and for routine maintenance operation.

!! Routine maintenance operations require a shut-off device on the unit's outlet pipe. Therefore we recommend combining it with one of the following options depending on the type of system: "V2ONX - On/OFF 2-way valve for variable flow-rate loop", "V2MODX - 2-way modulating valve for system with disposable water" or "VIMANX - Hand shut-off valve".

### Pressure drops of the VIFWX option

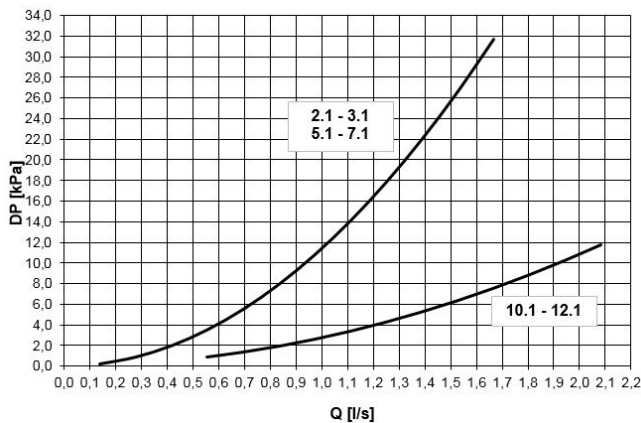

Q = Water flow-rate[l/s]

DP = Water side pressure drops (kPa)

### Water connection diagram

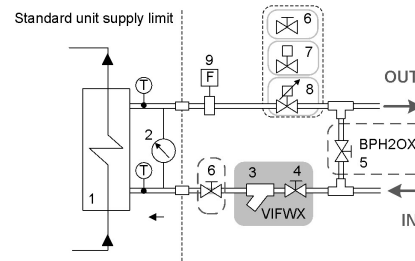

1. Internal exchanger with temperature probes
2. Differential pressure switch
3. Steel mesh strainer (included with the VIFWX accessory)
4. Hand shut-off valve (included in the VIFWX accessory)
5. Shut-off valve for by-pass (water side) (BPH2OX accessory)
- 6-7-8. Regulating / shut-off valves for the system (see the VIMANX, V2MODX and V2ONX accessories)
9. Flow switch

### VIFWX option technical features

Size	2.1 - 3.1	5.1 - 7.1	10.1 - 12.1
Filter diameter	1"	1"	1 1/2"
Water fitting diameter	1"	1"	1 1/2"
System side water fittings	FEMALE	FEMALE	FEMALE
Unit side water fittings	MALE	MALE	MALE
Max. operating pressure	10bar	10bar	10bar
Degree of filtration	400µm	400µm	500µm
Flow rate coefficient (Kvs)	11	11	22

# Accessories supplied separately

## CDPX - Condensate drain pump

Device which enables condensation water to be discharged into the collection tray in case it cannot drain away due to gravity. It is necessary in installations where the external outlet is placed at a higher height than the condensate tray. The integrated sensor activates the pump only when necessary. If the water level in the tray should be greater than the pre-set limit, the unit stops the compressor to avoid the tray overflowing, signalling the fault with an alarm.

!! The device is designed to be installed outside the unit (to be carried out by the Customer). The pack includes the 1m condensate drain flexible pipe and the 1.5m power supply cable

### Condensate drain pump

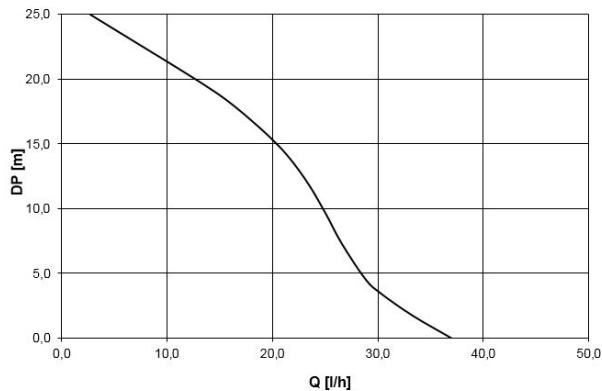

Q = Water flow-rate (in meters of water column)  
DP = Water side pressure drops (kPa)

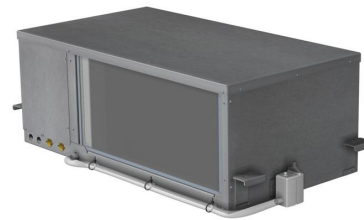

Installation pump example

## APFLX - Filter holder with access from the lower side

Device that facilitates the extraction of the air filters in case the unit is ducted or the section of recovery is not easily reachable, for example ceiling installations. It consists of a galvanised steel frame with door for removing the filter from below. The device is provided separately and it is to be installed using the filters already in the unit.

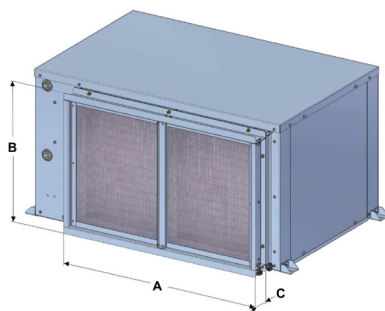

Filter extraction: from the side (standard)

### Filter frame dimensions

Size	A	B	C
2.1 - 3.1	625	460	100
5.1 - 7.1	845	560	100
10.1 - 12.1	1085	650	100

Filter extraction: from the bottom (optional)

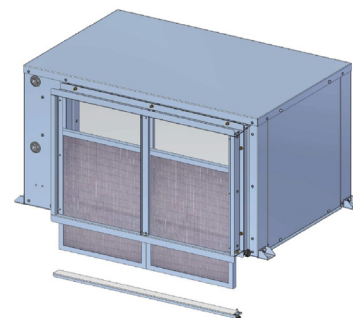
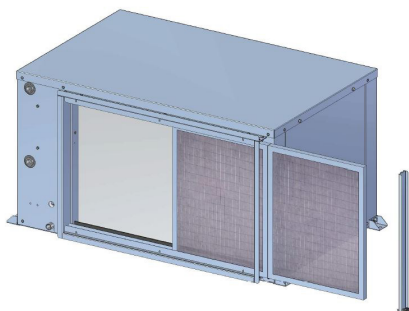

!! Provide for suitable access areas and clearances to remove the doors to take out the filter.

# Accessories supplied separately

## FLOX - Water control flow switch

Option for detecting the flow of water in the exchanger on the source side. It consists of a sensitive blade element that detects the flow of water. It permits operation within the allowable flow rates of the unit, avoiding the risk the risk of excessively low flow rates in the exchanger on the source side.

The device is in addition to the water flow control system already provided as standard in the unit, which is a differential pressure switch between the inlet and outlet of the exchanger on the water side.

!! Installed by the customer.

!! Provide spaces for installation on site.

## MOBX - Modbus RS485 serial kit port

It allows the serial connection to supervision systems, using Modbus as the communication protocol. It allows the access to the complete list of operating variables, controls and alarms. On the serial line can be connected up to 32 units for a typical distance of 1000 m. The connection is made using a suitable cable to RS485 network or formed by a twisted pair and shielded wires.

!! The device is ready for connecting to the electrical panel (installed by the customer).

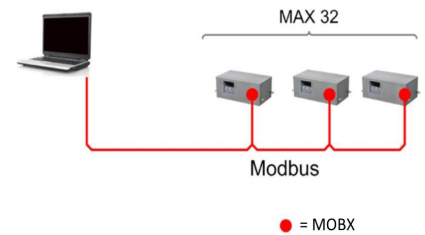

## BACX - BACnet communication serial module

Allows to perform the serial connection to supervision systems by using BACnet as a communication protocol. It allows the access to the entire list of operating variables, controls and alarms.

!! The device requires the coupling with the "RS485 serial port with Modbus protocol" MOBX option

!! The package includes the transformer, which is powered by 230/1/50, and the Gateway of communication between the supervisor and the Modbus serial line. The configuration and management of the BACnet network are the responsibility of the customer.

!! The device is prearranged to mounting in DIN rail, for external installation (7 DIN modules, installed by the customer)

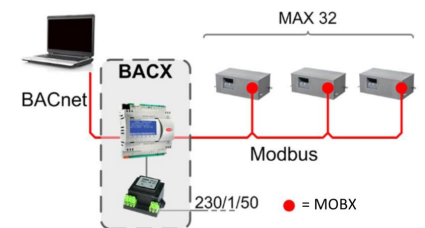

## AMMX - Spring antivibration mounts

The rubber antivibration mounts must be applied in designated areas on the support brackets and are used to dampen the vibrations produced by the unit by reducing the noise transmitted to the structures. They consist of steel spring elements inserted in elastomer retaining plates. They can dampen axial and tangential stress and their physical and mechanical properties remain constant over time thanks to the highly resistant materials they are made of.

!! The accessory includes the nut used for securing the item on the threaded bar. The bar used for ceiling installation (to be provided by the Customer) must have an M8 metric threading



## PCFM0 - Panels with M0 reaction to fire class

Internal coating of the air treatment area with fire-proof material. The panels of sheet metal have internal glass wool insulation with a black layer that keeps the fibres compact. It is used to ensure high quality thermoacoustic insulation. The material is 15mm thick, has a Euroclass A1 fire rating, and complies with the French legislation that requires class "M0" reaction to fire.

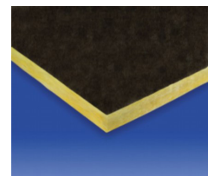

# General technical data

## Performance

Size			2.1	3.1	5.1	7.1	10.1	12.1
<b>Cooling</b>			<b>A 27/19 W 30</b>					
Cooling capacity (EN14511:2018)	1	kW	4,56	8,08	10,6	16,9	25,0	28,9
Total power input (EN14511:2018)	1	kW	1,30	2,07	3,04	4,15	5,85	7,43
EER (EN14511:2018)	1		3,52	3,90	3,53	4,07	4,27	3,89
SEER	2		3,28	3,93	3,57	4,23	4,47	3,97
Cooling capacity	3	kW	4,81	8,46	11,2	17,9	25,9	30,8
Sensible capacity	3	kW	3,74	6,44	8,84	13,9	20,0	22,4
Compressor power input	3	kW	0,96	1,61	2,27	3,07	4,74	5,36
Total power input	3	kW	1,34	2,09	3,13	4,29	6,11	7,75
<b>Heating</b>			<b>A 20 W 20</b>					
Heating capacity (EN14511:2018)	4	kW	7,55	10,3	14,4	23,1	33,2	38,2
Total power input (EN14511:2018)	4	kW	1,75	2,39	3,35	5,23	7,21	8,47
COP (EN14511:2018)	4		4,30	4,31	4,30	4,41	4,60	4,52
SCOP	2		3,81	3,82	3,81	3,91	4,08	4,01
Heating capacity	5	kW	7,06	9,83	13,5	22,1	32,3	36,4
Compressor power input	5	kW	1,46	1,99	2,56	4,02	6,04	6,23
Total power input	5	kW	1,76	2,4	3,4	5,3	7,3	8,6
<b>Compressor</b>								
Type of compressors	6		ROT	ROT	ROT	SCROLL	SCROLL	SCROLL
No. of compressors			1	1	1	1	1	1
Refrigerant charge		kg	0,7	0,95	1,1	1,3	3,2	4,1
<b>Air Handling Section Fans (Supply)</b>								
Type of fans	7		CFG	CFG	CFG	CFG	CFG	CFG
No. of fans			1	1	1	1	1	1
Airflow	8	l/s	278	416	778	1056	1351	1657
Airflow		m <sup>3</sup> /h	1000	1500	2800	3800	4900	6000
Max external static pressure	9	Pa	250	270	290	310	220	410
Fan speed	10		L	M	M	H	H	M
<b>External section</b>								
Water flow-rate	11	l/s	0,27	0,47	0,64	1,00	1,47	1,72
Pressure drop	12	kPa	13,0	15,8	17,6	19,4	18,6	20,4
<b>Connections</b>								
Water fittings	13	inch	1"	1"	1"	1"	1" 1/2"	1" 1/2"
Condensate drain	14	mm	22	22	22	22	22	22
<b>Power supply</b>								
Standard power supply			220-240V ~ 50Hz	220-240V ~ 50Hz	220-240V ~ 50Hz	380-415V 3N ~ 50Hz	380-415V 3N ~ 50Hz	380-415V 3N ~ 50Hz

Contains fluorinated greenhouse gases (GWP 2087,5)

The Product is compliant with the Erp (Energy Related Products) European Directive. It includes the Commission delegated Regulation (EU) No 2016/2281, also known as Ecodesign Lot21.

A 27/19 W 30 = Unit inlet air temperature 27°C D.B. / 19°C W.B. Unit inlet water temperature

A 20 W 20 = Unit inlet air temperature 20°C Unit inlet water temperature 20°C

DB = Dry bulb WB = Wet bulb

1. Ambient air 27°C D.B./19°C W.B. Exchanger water temperature 30°C / 35°C. Values read in compliance with EN14511:2018 and including the required system fan motor and water pump capacity for overcoming pressure drops inside the unit.
2. SEER e SCOP in conformità EN 14825-2016.
3. Prestazioni lorda. Ambient air 27°C D.B./19°C W.B. Exchanger water temperature 30°C / 35°C. The value does not take into account the power of the fan's motor and the part related to the pumps and required to overcome the pressure drops for the circulation of the solution inside the exchangers.
4. Ambient air 20°C D.B. Exchanger inlet water temperature 20°C. The water temperature at the exchanger output is read in relation to the flow of water being chilled. Values read in compliance with EN14511:2018 and including the required system fan motor and water pump capacity for overcoming pressure drops inside the unit.
5. Ambient air 20°C D.B. Exchanger inlet water temperature 20°C. The value does not take into account the power of the fan's motor and the part related to the pumps and

required to overcome the pressure drops for the circulation of the solution inside the exchangers

6. ROT = Rotary compressor. SCROLL = Scroll compressor
7. CFG = Centrifugal fan
8. Standard airflow
9. Available static pressure with standard air flow and clean air filter
10. Performances referred to the standard speed (STD): L = Low Extraquiet; M = Medium Quiet; H = High Powerful
11. Water flow calculated in relation to the performances in cooling.
12. Total pressure drop of the standard unit (without optional hydraulic pipe works). To obtain the total drops with any additional hydraulic components see accessory section.
13. Water inlet/outlet diameter
14. Condensation drain pipe, external diameter

# General technical data

## Electrical data

Size			2.1	3.1	5.1	7.1	10.1	12.1
<b>F.L.A. - Full load current at max admissible conditions</b>								
F.L.A. - Compressor 1		A	7,35	11,70	16,57	10,43	13,90	16,56
F.L.A. - Single supply fan		A	4,60	4,60	6,80	6,80	7,60	4,90
F.L.A. - Total		A	11,95	16,30	23,37	17,23	21,50	21,46
<b>L.R.A. Inrush current</b>								
L.R.A. - Compressor 1		A	25,9	60,0	74,0	67,1	101,0	111,0
<b>F.L.I. - Full load power input at max admissible conditions</b>								
F.L.I. - Compressor 1		kW	1,58	2,49	3,56	6,70	8,57	10,20
F.L.I. - Single supply fan		kW	1,00	1,00	1,50	1,50	1,67	1,10
F.L.I. - Total		kW	2,58	3,49	5,06	8,20	10,24	11,30
<b>M.I.C. Maximum inrush current</b>								
M.I.C. - Value		A	30,50	64,60	80,80	73,90	108,60	115,90

Data refer to standard units.

Power supply: 220-240V ~ 50Hz Voltage variation: max. +/-10%

# General technical data

## Sound levels - Extraquiet = Minimum fan speed (L)

Size	Sound Power Level								Sound Pressure Level	Sound Power Level
	Octave band [Hz]									
	63	125	250	500	1000	2000	4000	8000	dB(A)	dB(A)
2.1	30	47	47	49	45	42	37	32	37	50
3.1	30	47	48	49	46	42	36	31	38	51
5.1	34	53	54	51	49	44	32	34	40	54
7.1	35	53	54	52	50	44	31	33	41	54
10.1	48	54	55	58	52	47	42	35	44	58
12.1	59	57	62	61	59	56	50	55	50	64

## Sound levels - Quiet = Medium fan speed (M)

Size	Sound Power Level								Sound Pressure Level	Sound Power Level
	Octave band [Hz]									
	63	125	250	500	1000	2000	4000	8000	dB(A)	dB(A)
2.1	34	49	50	53	49	47	43	33	42	55
3.1	34	49	50	54	49	47	42	33	42	55
5.1	35	55	56	56	54	49	37	39	44	58
7.1	35	56	57	55	54	49	38	39	45	58
10.1	49	53	56	59	53	48	43	38	45	59
12.1	59	57	62	61	59	56	50	55	50	64

## Sound levels - Powerful = Maximum fan speed (H)

Size	Sound Power Level								Sound Pressure Level	Sound Power Level
	Octave band [Hz]									
	63	125	250	500	1000	2000	4000	8000	dB(A)	dB(A)
2.1	42	53	54	58	57	54	51	37	48	62
3.1	42	53	54	58	57	55	52	37	49	62
5.1	42	57	59	58	59	54	49	36	48	62
7.1	42	58	59	58	58	54	49	35	49	62
10.1	54	54	60	60	55	51	46	41	47	61
12.1	59	59	64	62	63	60	53	56	53	67

Sound levels refer to the unit at full load installed on the ceiling, ducted, with minimum, standard and maximum air flow rate of the fan. Available static pressure 40 Pa.

In accordance with the UNI-EN ISO 3744 regulation, the average sound pressure level refers to a distance of 1 m from the outer surface of a ducted unit installed on the ceiling.

Measurements are made in accordance to the UNI EN ISO 9614-2, with units installed over two sound reflective surfaces.

If the unit is installed in conditions other than the nominal ones (for instance, near walls or obstacles in generally) the sound levels may undergo substantial variations.



# General technical data

## Operating range (Cooling)

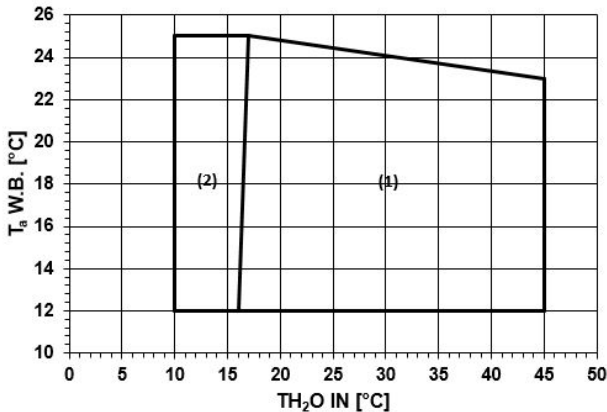

### WET BULB TEMPERATURE - EXAMPLE

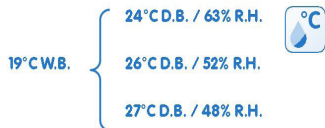

!! The graph refers to a water temperature differential of 5°C with a reduced water flow rate, the temperature differential is more than 5°C, so it is necessary to reduce the specified operating range for steps exceeding the nominal 5°C.  
 Example: with a temperature differential of 8°C, the upper TH<sub>2</sub>O limit is no longer 45°C but 42°C.

The limits are meant as an indication and they have been calculated by considering:

- general and non specific sizes
- standard airflow (Fan speed: Standard)
- non-critical positioning and correct use of the unit
- operation at full load
- difference between inlet / outlet water temperature = 5°C

T<sub>a</sub> = Handling air coil entering air temperature (°C)

WARNING! Wet bulb temperature

(W.B. = WET BULB)

TH<sub>2</sub>O = Water temperature at plate exchanger input (°C)

1. Standard operating range
2. Operating range for unit equipped with "V2MODX - 2-way modulating valve for installation with disposable water" option, i.e., groundwater or anyway a source at low water temperature. By this option the water feeding system must be at variable flow-rate.

## Operating range (Heating)

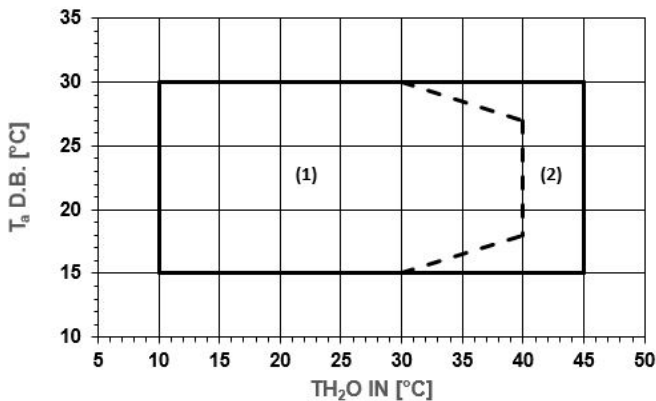

The limits are meant as an indication and they have been calculated by considering:

- general and non specific sizes
  - standard airflow (Fan speed: Standard)
  - non-critical positioning and correct use of the unit
  - foperation at full load
  - difference between inlet / outlet water temperature = 5°C
- T<sub>a</sub> = handling air coil entering air temperature (°C)  
 WARNING! Dry bulb temperature (d.b.=dry bulb)

TH<sub>2</sub>O = Water temperature at plate exchanger input (°C)

1. Standard operating range.
2. Standard unit operating range. In this range the COP efficiency can be increased equipping the unit with the "V2MODX - 2-way modulating valve for installation with disposable water" option, that controls the heat exchange with the source. In this way the unit performances are similar to the unit ones with feeding water temperature (TH<sub>2</sub>O) equal to 25°C. With this option the water feeding system must be at variable flow-rate.

!! The graph refers to a water temperature differential of 5°C with a reduced water flow rate, the temperature differential is more than 5°C, so it is necessary to reduce the specified operating range for steps exceeding the nominal 5°C.  
 Example: with a temperature differential of 8°C, the lower TH<sub>2</sub>O limit is no longer 10°C but 13°C.

# General technical data

## Standard unit water circuit pressure drops

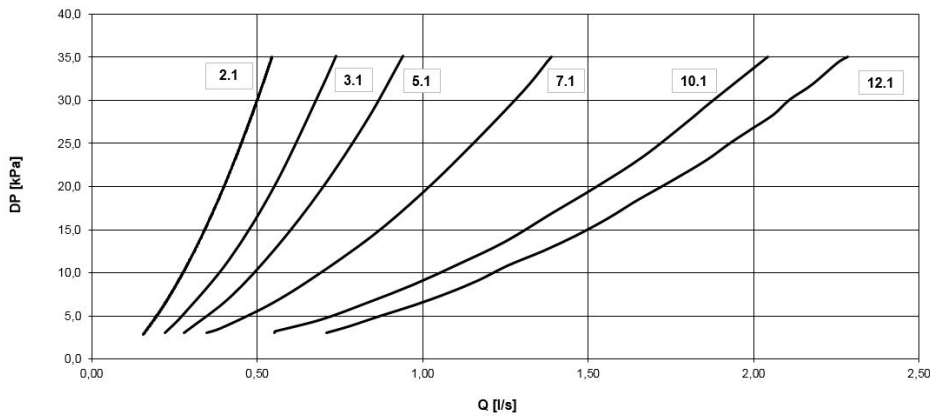

Q = water flow-rate (l/s)  
DP = water side pressure drops (kPa)

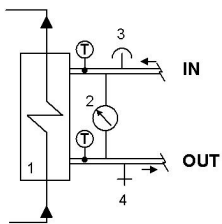

The standard unit includes the following components:

1. plate exchanger and water temperature control probes on the inlet and the outlet (to preventive from forming and to disable the compressor when the water temperature drops below a limit value)
2. water side differential pressure switch (to control the water flow- rate presence)
3. relief valve (to allow the air to bleed out from the system)
4. drain valve (to allow to drain the exchanger for maintenance operations).

It does not include other shut-off or control parts.

## Water flow-rate

Size		2.1	3.1	5.1	7.1	10.1	12.1.
Q min	[l/s]	0,16	0,23	0,28	0,35	0,56	0,71
Q standard (1)	[l/s]	0,37	0,48	0,65	1	1,47	1,74
Q max	[l/s]	0,46	0,74	0,94	1,39	2,04	2,28

Minimum and maximum allowable water flow rate from the unit

1. Water flow rate at nominal conditions with water temperature in / out 5°C.

# General technical data

## Airflow / head curves

Size 2.1

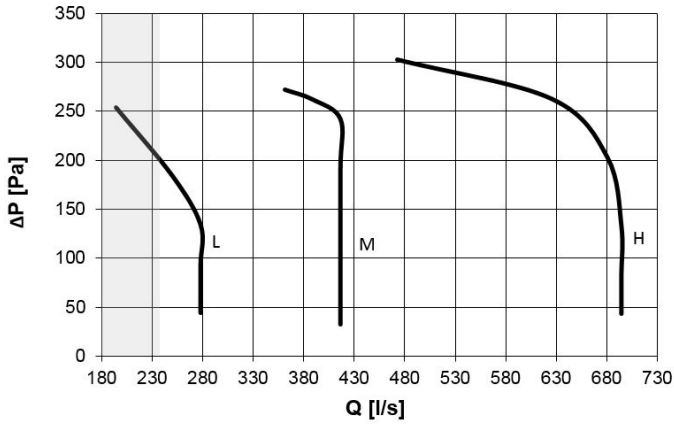

Size 3.1

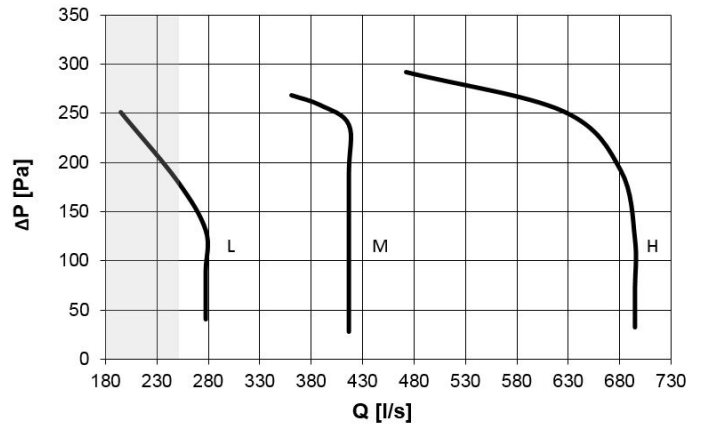

Size 5.1

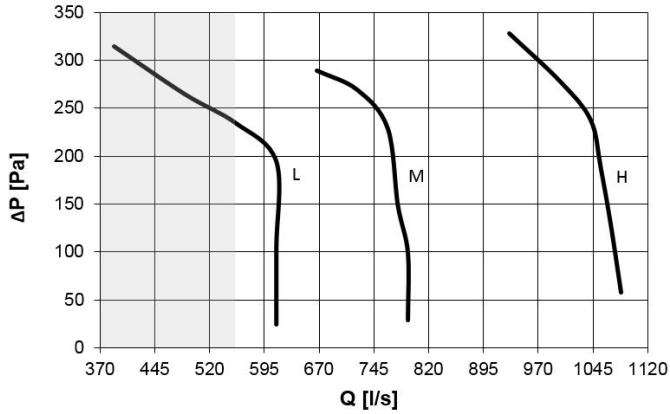

Size 7.1

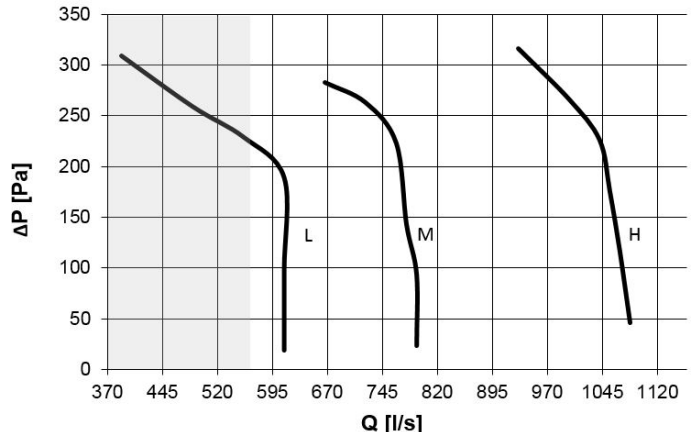

Size 10.1

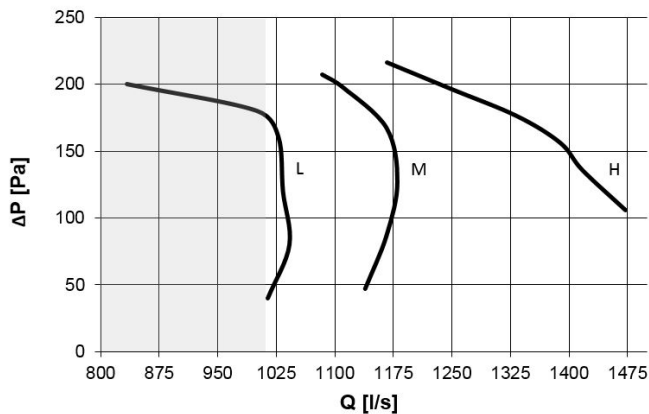

Size 12.1

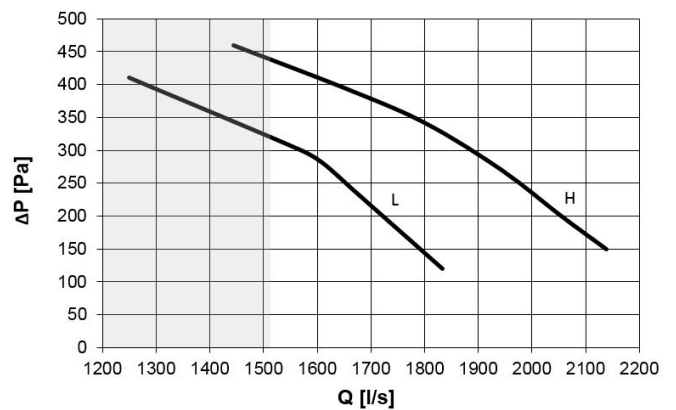

The letters next to the identification number of the unit size indicate:  
 L = Minimum speed (Extra-quiet)  
 M = Average speed (Quiet)  
 H = Maximum speed (Powerful)  
 Q = Airflow (l/s)  
 DP = Available pressure (Pa)  
 The grey area identifies the minimum allowable airflow which guarantees the correct air distribution on the internal exchanger.

Size	Minimum air flow	
	[m <sup>3</sup> /h]	[l/s]
2.1	880	244
3.1	900	250
5.1	2000	556
7.1	2000	566
10.1	3600	1000
12.1	5800	1611

# General technical data

## Performances in cooling

### Size 2.1

Air flow rate	Water outlet temperature [°C]	23				26				29				32				35				40			
	Room temperature D.B./W.B. [°C]	kWf	kWs	kWe	EER	kWf	kWs	kWe	EER	kWf	kWs	kWe	EER	kWf	kWs	kWe	EER	kWf	kWs	kWe	EER	kWf	kWs	kWe	EER
L 1000 m <sup>3</sup> /h (Std)	22/16	4,81	3,50	0,68	7,07	4,72	3,46	0,75	6,29	4,60	3,41	0,83	5,54	4,47	3,37	0,90	4,97	4,34	3,34	0,96	4,52	4,19	3,24	1,07	3,92
	24/17	-	-	-	-	4,90	3,67	0,74	6,62	4,78	3,62	0,83	5,76	4,65	3,58	0,90	5,17	4,51	3,55	0,96	4,70	4,36	3,45	1,07	4,07
	26/18	-	-	-	-	5,09	3,88	0,73	6,97	4,95	3,84	0,82	6,04	4,82	3,80	0,89	5,42	4,68	3,76	0,96	4,88	4,54	3,65	1,07	4,24
	27/19	-	-	-	-	-	-	-	-	5,07	3,82	0,82	6,18	4,94	3,78	0,89	5,55	4,81	3,74	0,96	5,01	4,67	3,62	1,07	4,36
	28/20	-	-	-	-	-	-	-	-	5,22	3,77	0,81	6,44	5,08	3,74	0,89	5,71	4,94	3,69	0,96	5,15	4,80	3,58	1,07	4,49
	30/22	-	-	-	-	-	-	-	-	-	-	-	5,35	3,64	0,88	6,08	5,20	3,61	0,95	5,47	5,04	3,51	1,07	4,71	
M 1500 m <sup>3</sup> /h	22/16	-	-	-	-	5,04	3,89	0,74	6,81	4,91	3,84	0,82	5,99	4,78	3,79	0,90	5,31	4,63	3,75	0,96	4,82	4,49	3,63	1,07	4,20
	24/17	-	-	-	-	5,24	4,17	0,73	7,18	5,12	4,12	0,82	6,24	4,97	4,08	0,89	5,58	4,81	4,05	0,96	5,01	4,67	3,92	1,07	4,36
	26/18	-	-	-	-	5,44	4,46	0,72	7,56	5,31	4,41	0,81	6,56	5,16	4,37	0,89	5,80	5,01	4,34	0,96	5,22	4,85	4,23	1,07	4,53
	27/19	-	-	-	-	-	-	-	-	5,44	4,37	0,81	6,72	5,29	4,33	0,88	6,01	5,14	4,29	0,95	5,41	4,97	4,19	1,07	4,64
	28/20	-	-	-	-	-	-	-	-	5,58	4,32	0,80	6,98	5,43	4,28	0,88	6,17	5,27	4,24	0,95	5,55	5,10	4,14	1,07	4,77
	30/22	-	-	-	-	-	-	-	-	-	-	-	5,70	4,16	0,87	6,55	5,55	4,12	0,94	5,90	5,35	4,04	1,06	5,05	
H 2500 m <sup>3</sup> /h	22/16	-	-	-	-	-	-	-	-	5,24	4,42	0,81	6,47	5,10	4,36	0,89	5,73	4,97	4,30	0,96	5,18	4,78	4,17	1,07	4,47
	24/17	-	-	-	-	-	-	-	-	5,44	4,88	0,81	6,72	5,30	4,82	0,88	6,02	5,16	4,75	0,95	5,43	4,95	4,62	1,07	4,63
	26/18	-	-	-	-	-	-	-	-	-	-	-	-	5,53	5,22	0,88	6,28	5,38	5,18	0,95	5,66	5,17	5,06	1,07	4,83
	27/19	-	-	-	-	-	-	-	-	-	-	-	-	5,68	5,15	0,87	6,53	5,53	5,11	0,94	5,88	5,32	5,02	1,06	5,02
	28/20	-	-	-	-	-	-	-	-	-	-	-	-	-	-	-	-	5,67	5,02	0,94	6,03	5,46	4,94	1,06	5,15
	30/22	-	-	-	-	-	-	-	-	-	-	-	-	-	-	-	5,97	4,84	0,93	6,42	5,73	4,79	1,06	5,41	

### Size 3.1

Air flow rate	Water outlet temperature [°C]	23				26				29				32				35				40			
	Room temperature D.B./W.B. [°C]	kWf	kWs	kWe	EER	kWf	kWs	kWe	EER	kWf	kWs	kWe	EER	kWf	kWs	kWe	EER	kWf	kWs	kWe	EER	kWf	kWs	kWe	EER
L 1000 m <sup>3</sup> /h	22/16	7,75	5,18	1,21	6,40	7,60	5,17	1,30	5,85	7,40	5,15	1,41	5,25	7,20	5,12	1,52	4,74	7,02	5,09	1,63	4,31	6,70	4,98	1,81	3,70
	24/17	8,06	5,43	1,20	6,72	7,90	5,41	1,29	6,12	7,69	5,39	1,41	5,45	7,49	5,37	1,52	4,93	7,29	5,34	1,63	4,47	6,93	5,27	1,81	3,83
	26/18	8,39	5,65	1,19	7,05	8,24	5,64	1,28	6,44	8,01	5,62	1,40	5,72	7,80	5,59	1,52	5,13	7,60	5,57	1,63	4,66	7,23	5,48	1,81	3,99
	27/19	-	-	-	-	8,46	5,60	1,27	6,66	8,23	5,58	1,39	5,92	8,01	5,56	1,51	5,30	7,80	5,53	1,62	4,81	7,43	5,44	1,81	4,10
	28/20	-	-	-	-	8,68	5,55	1,26	6,89	8,44	5,53	1,39	6,07	8,22	5,51	1,51	5,44	8,01	5,48	1,62	4,94	7,63	5,40	1,81	4,22
	30/22	-	-	-	-	-	-	-	8,88	5,43	1,37	6,48	8,65	5,41	1,50	5,77	8,42	5,39	1,61	5,23	8,02	5,31	1,81	4,43	
M 1500 m <sup>3</sup> /h (std)	22/16	8,34	5,99	1,19	7,01	8,19	5,97	1,28	6,40	7,98	5,93	1,40	5,70	7,80	5,87	1,52	5,13	7,64	5,79	1,63	4,69	7,32	5,63	1,81	4,04
	24/17	8,69	6,32	1,18	7,36	8,53	6,31	1,27	6,72	8,30	6,28	1,39	5,97	8,10	6,23	1,51	5,36	7,91	6,18	1,62	4,88	7,58	6,02	1,81	4,19
	26/18	-	-	-	-	8,89	6,61	1,25	7,11	8,65	6,58	1,38	6,27	8,44	6,54	1,50	5,63	8,24	6,49	1,62	5,09	7,91	6,34	1,81	4,37
	27/19	-	-	-	-	9,12	6,55	1,24	7,35	8,87	6,52	1,38	6,43	8,66	6,48	1,50	5,77	8,46	6,44	1,61	5,25	8,13	6,28	1,81	4,49
	28/20	-	-	-	-	-	-	-	-	9,11	6,45	1,37	6,65	8,89	6,41	1,49	5,97	8,68	6,37	1,61	5,39	8,34	6,21	1,80	4,63
	30/22	-	-	-	-	-	-	-	9,57	6,30	1,35	7,09	9,34	6,26	1,47	6,35	9,11	6,23	1,60	5,69	8,78	6,05	1,80	4,88	
H 2500 m <sup>3</sup> /h	22/16	9,02	7,00	1,16	7,78	8,88	6,96	1,25	7,10	8,67	6,90	1,38	6,28	8,49	6,80	1,50	5,66	8,34	6,70	1,61	5,18	8,01	6,50	1,81	4,43
	24/17	9,38	7,52	1,15	8,16	9,23	7,48	1,24	7,44	9,01	7,43	1,37	6,58	8,84	7,33	1,49	5,93	8,69	7,22	1,61	5,40	8,36	7,02	1,80	4,64
	26/18	-	-	-	-	9,64	7,96	1,22	7,90	9,40	7,92	1,35	6,96	9,21	7,84	1,48	6,22	9,05	7,73	1,60	5,66	8,67	7,57	1,80	4,82
	27/19	-	-	-	-	9,89	7,86	1,20	8,24	9,64	7,82	1,34	7,19	9,45	7,74	1,47	6,43	9,28	7,64	1,59	5,84	8,88	7,48	1,80	4,93
	28/20	-	-	-	-	-	-	-	-	9,87	7,70	1,33	7,42	9,67	7,62	1,46	6,62	9,49	7,53	1,59	5,97	9,09	7,38	1,79	5,08
	30/22	-	-	-	-	-	-	-	-	-	-	-	10,12	7,38	1,45	6,98	9,91	7,31	1,57	6,31	9,50	7,18	1,78	5,34	

Performances referred to three air flows available

kWf = Cooling capacity in kW (gross)

kWs = Sensible cooling capacity in kW

kWe = Electrical power absorbed by compressor in kW

EER = Referred to compressors only

The cooling capacities have not accounted for the heat dissipation of the fan motors.

Airflow:

L = Low Extraquiet

M = Medium Quiet

H = High Powerful

Std = Standard airflow referred to the general technical data.



# General technical data

## Performances in cooling

### Size 10.1

Air flow rate	Water outlet temperature [°C]	23				26				29				32				35				40			
	Room temperature D.B./W.B. [°C]	kWf	kWs	kWe	EER	kWf	kWs	kWe	EER	kWf	kWs	kWe	EER	kWf	kWs	kWe	EER	kWf	kWs	kWe	EER	kWf	kWs	kWe	EER
L 3700 m³/h	22/16	24,6	17,0	3,49	7,05	24,0	16,9	3,76	6,39	23,3	16,9	4,11	5,67	22,7	16,8	4,42	5,14	22,2	16,7	4,70	4,72	21,4	16,2	5,22	4,10
	24/17	25,6	17,9	3,48	7,36	25,0	17,9	3,76	6,65	24,3	17,8	4,11	5,91	23,7	17,7	4,43	5,34	23,1	17,7	4,71	4,90	22,2	17,3	5,23	4,25
	26/18	26,7	18,7	3,48	7,66	26,0	18,7	3,76	6,92	25,3	18,6	4,12	6,13	24,6	18,6	4,43	5,56	24,0	18,5	4,73	5,08	23,0	18,2	5,24	4,40
	27/19	27,3	18,6	3,47	7,86	26,7	18,5	3,75	7,11	25,9	18,5	4,12	6,28	25,2	18,4	4,44	5,68	24,7	18,3	4,73	5,21	23,6	18,0	5,25	4,50
	28/20	28,0	18,3	3,47	8,05	27,3	18,3	3,75	7,28	26,5	18,2	4,12	6,43	25,8	18,1	4,44	5,82	25,2	18,1	4,74	5,32	24,2	17,7	5,26	4,61
	30/22	29,3	17,9	3,46	8,46	28,6	17,8	3,75	7,62	27,7	17,8	4,12	6,73	27,0	17,7	4,44	6,09	26,4	17,6	4,75	5,56	25,5	17,3	5,27	4,83
M 4200 m³/h	22/16	25,1	17,7	3,49	7,20	24,6	17,6	3,76	6,53	23,9	17,5	4,11	5,81	23,3	17,4	4,42	5,28	22,8	17,2	4,71	4,85	22,0	16,8	5,23	4,20
	24/17	26,2	18,7	3,48	7,52	25,6	18,6	3,76	6,80	24,8	18,5	4,12	6,03	24,2	18,5	4,43	5,47	23,7	18,4	4,72	5,02	22,7	18,0	5,24	4,34
	26/18	27,2	19,6	3,47	7,85	26,6	19,6	3,75	7,10	25,8	19,5	4,12	6,27	25,2	19,4	4,44	5,68	24,6	19,3	4,73	5,21	23,6	19,0	5,25	4,49
	27/19	27,9	19,4	3,47	8,03	27,2	19,3	3,75	7,26	26,4	19,3	4,12	6,42	25,8	19,2	4,44	5,81	25,3	19,1	4,74	5,33	24,2	18,8	5,26	4,59
	28/20	28,6	19,1	3,46	8,25	27,9	19,1	3,75	7,43	27,1	19,0	4,12	6,57	26,4	18,9	4,44	5,95	25,8	18,8	4,74	5,45	24,8	18,5	5,26	4,71
	30/22	29,9	18,6	3,45	8,66	29,2	18,6	3,74	7,80	28,3	18,5	4,12	6,87	27,6	18,5	4,44	6,21	26,9	18,4	4,75	5,66	26,1	17,9	5,27	4,94
H 4900 m³/h (Std)	22/16	25,7	18,6	3,48	7,39	25,2	18,5	3,76	6,69	24,5	18,3	4,11	5,96	23,9	18,2	4,43	5,40	23,5	18,0	4,72	4,97	22,6	17,5	5,24	4,31
	24/17	26,8	19,7	3,48	7,70	26,2	19,6	3,76	6,97	25,5	19,5	4,12	6,19	24,9	19,3	4,44	5,61	24,4	19,2	4,73	5,15	23,4	18,8	5,25	4,46
	26/18	27,9	20,7	3,47	8,05	27,3	20,7	3,75	7,28	26,5	20,6	4,12	6,43	25,9	20,5	4,44	5,83	25,3	20,3	4,74	5,34	24,4	19,9	5,26	4,63
	27/19	28,6	20,5	3,46	8,26	27,9	20,4	3,75	7,45	27,1	20,3	4,12	6,58	26,5	20,2	4,44	5,96	25,9	20,1	4,74	5,47	25,0	19,7	5,27	4,74
	28/20	29,3	20,2	3,46	8,46	28,6	20,1	3,74	7,64	27,8	20,1	4,12	6,74	27,1	19,9	4,44	6,10	26,5	19,8	4,75	5,58	25,5	19,4	5,27	4,84
	30/22	30,6	19,6	3,44	8,89	29,9	19,6	3,73	8,01	29,0	19,5	4,11	7,06	28,3	19,4	4,44	6,37	27,7	19,3	4,75	5,82	26,6	18,9	5,28	5,04

### Size 12.1

Air flow rate	Water outlet temperature [°C]	23				26				29				32				35				40			
	Room temperature D.B./W.B. [°C]	kWf	kWs	kWe	EER	kWf	kWs	kWe	EER	kWf	kWs	kWe	EER	kWf	kWs	kWe	EER	kWf	kWs	kWe	EER	kWf	kWs	kWe	EER
M 6000 m³/h (Std)	22/16	30,8	20,6	3,87	7,95	30,1	20,6	4,38	6,87	29,2	20,5	4,90	5,96	28,4	20,4	5,16	5,51	27,7	20,3	5,30	5,23	26,4	20,2	5,90	4,48
	24/17	32,1	21,9	3,86	8,30	31,3	21,8	4,46	7,02	30,4	21,8	5,02	6,06	29,6	21,7	5,25	5,64	28,9	21,5	5,32	5,43	27,5	21,5	5,92	4,64
	26/18	33,4	23,0	3,92	8,53	32,7	23,0	4,41	7,41	31,7	22,9	4,90	6,47	30,9	22,8	5,17	5,97	30,1	22,6	5,34	5,64	28,6	22,7	5,94	4,82
	27/19	34,2	22,8	3,95	8,66	33,5	22,7	4,39	7,62	32,5	22,7	4,84	6,71	31,6	22,6	5,14	6,15	30,8	22,4	5,36	5,75	29,3	22,4	5,96	4,92
	28/20	35,0	22,5	3,98	8,80	34,2	22,5	4,38	7,82	33,2	22,4	4,80	6,93	32,4	22,3	5,12	6,32	31,5	22,1	5,38	5,86	30,0	22,1	5,98	5,02
	30/22	36,6	21,9	4,04	9,07	35,8	21,9	4,35	8,23	34,8	21,8	4,75	7,32	33,8	21,7	5,10	6,63	33,0	21,5	5,42	6,08	31,4	21,5	6,01	5,23
H 7000 m³/h	22/16	31,5	21,7	3,87	8,13	30,8	21,7	4,41	6,98	29,9	21,6	4,93	6,05	29,1	21,5	5,19	5,61	28,4	21,3	5,31	5,35	27,2	21,1	5,92	4,60
	24/17	32,8	23,1	3,87	8,47	32,0	23,1	4,49	7,13	31,1	23,0	5,04	6,17	30,3	22,9	5,27	5,75	29,6	22,7	5,33	5,55	28,2	22,6	5,93	4,76
	26/18	34,2	24,4	3,95	8,66	33,5	24,4	4,38	7,64	32,5	24,3	4,83	6,72	31,6	24,2	5,14	6,15	30,8	24,0	5,36	5,75	29,3	24,0	5,96	4,92
	27/19	35,0	24,1	4,00	8,76	34,2	24,1	4,33	7,91	33,2	24,1	4,73	7,03	32,4	23,9	5,07	6,38	31,5	23,8	5,38	5,86	30,0	23,8	5,97	5,03
	28/20	35,9	23,8	4,02	8,92	35,0	23,8	4,34	8,07	34,0	23,7	4,74	7,18	33,1	23,6	5,09	6,50	32,3	23,4	5,40	5,97	30,7	23,4	5,99	5,13
	30/22	37,5	23,1	4,06	9,23	36,6	23,1	4,37	8,38	35,5	23,0	4,77	7,45	34,6	22,9	5,12	6,75	33,7	22,7	5,45	6,19	32,1	22,8	6,03	5,32

Performances referred to three air flows available

kWf = Cooling capacity in kW (gross)

kWs = Sensible cooling capacity in kW

kWe = Electrical power absorbed by compressor in kW

EER = Referred to compressors only

The cooling capacities have not accounted for the heat dissipation of the fan motors.

Airflow:

L = Low Extraquiet

M = Medium Quiet

H = High Powerful

Std = Standard airflow referred to the general technical data.

# General technical data

## Performance in Heating

### Size 2.1

Air flow rate	Water outlet temperature[°C]	5			9			13			17			19			25		
	Room temperature D.B. [°C]	kWt	kWe	COP	kWt	kWe	COP	kWt	kWe	COP	kWt	kWe	COP	kWt	kWe	COP	kWt	kWe	COP
L 1000 m <sup>3</sup> /h (Std)	10	-	-	-	-	-	-	7,16	1,13	6,34	7,52	1,19	6,32	7,99	1,23	6,50	8,47	1,27	6,67
	15	-	-	-	6,32	1,20	5,27	6,98	1,25	5,58	7,31	1,33	5,50	7,75	1,37	5,66	8,16	1,41	5,79
	18	5,75	1,20	4,79	6,22	1,27	4,90	6,85	1,32	5,19	7,16	1,41	5,08	7,56	1,46	5,18	7,95	1,50	5,30
	20	5,69	1,25	4,55	6,15	1,31	4,69	6,76	1,37	4,93	7,06	1,46	4,84	7,42	1,51	4,91	7,79	1,56	4,99
	22	5,62	1,29	4,36	6,07	1,36	4,46	6,67	1,43	4,66	6,94	1,52	4,57	7,29	1,57	4,64	7,66	1,61	4,76
	25	5,52	1,35	4,09	5,94	1,42	4,18	6,52	1,51	4,32	6,75	1,60	4,22	7,11	1,65	4,31	7,46	1,70	4,39
M 1500 m <sup>3</sup> /h	10	-	-	-	-	-	-	-	-	-	-	-	-	-	-	-	8,86	1,06	8,36
	15	-	-	-	6,47	1,07	6,05	7,19	1,11	6,48	7,59	1,16	6,54	8,06	1,19	6,77	8,60	1,22	7,05
	18	5,87	1,10	5,34	6,39	1,14	5,61	7,09	1,19	5,96	7,47	1,25	5,98	7,92	1,27	6,24	8,41	1,31	6,42
	20	5,82	1,15	5,06	6,34	1,19	5,33	7,02	1,24	5,66	7,39	1,30	5,68	7,83	1,33	5,89	8,28	1,36	6,09
	22	5,76	1,19	4,84	6,26	1,24	5,05	6,92	1,29	5,36	7,26	1,36	5,34	7,70	1,39	5,54	8,13	1,42	5,73
	25	5,67	1,26	4,50	6,14	1,31	4,69	6,77	1,36	4,98	7,08	1,45	4,88	7,51	1,48	5,07	7,91	1,51	5,24
H 2500 m <sup>3</sup> /h	10	-	-	-	-	-	-	-	-	-	-	-	-	-	-	-	-	-	-
	15	-	-	-	-	-	-	-	-	-	-	-	-	8,28	1,02	8,12	8,92	1,02	8,75
	18	5,96	1,02	5,84	6,50	1,04	6,25	7,24	1,06	6,83	7,66	1,10	6,96	8,17	1,11	7,36	8,77	1,12	7,83
	20	5,92	1,06	5,58	6,46	1,09	5,93	7,18	1,12	6,41	7,58	1,15	6,59	8,09	1,17	6,91	8,65	1,19	7,27
	22	5,87	1,11	5,29	6,41	1,13	5,67	7,12	1,17	6,09	7,50	1,21	6,20	8,00	1,23	6,50	8,52	1,25	6,82
	25	5,79	1,18	4,91	6,32	1,21	5,22	7,01	1,24	5,65	7,37	1,30	5,67	7,85	1,32	5,95	8,33	1,34	6,22

### Size 3.1

Air flow rate	Water outlet temperature[°C]	5			9			13			17			19			25		
	Room temperature D.B. [°C]	kWt	kWe	COP	kWt	kWe	COP	kWt	kWe	COP	kWt	kWe	COP	kWt	kWe	COP	kWt	kWe	COP
L 1000 m <sup>3</sup> /h	10	-	-	-	8,41	1,73	4,86	9,12	1,83	4,98	9,89	1,93	5,12	10,4	2,01	5,16	10,9	2,08	5,22
	15	7,51	1,81	4,15	8,24	1,91	4,31	8,87	2,02	4,39	9,56	2,14	4,47	10,0	2,22	4,51	10,5	2,31	4,54
	18	7,45	1,89	3,94	8,14	2,01	4,05	8,80	2,13	4,13	9,37	2,27	4,13	9,81	2,36	4,16	10,3	2,48	4,15
	20	7,42	1,93	3,84	8,06	2,07	3,89	8,77	2,20	3,99	9,25	2,37	3,90	9,68	2,45	3,95	10,2	2,59	3,93
	22	7,25	2,03	3,57	7,89	2,17	3,64	8,53	2,31	3,69	9,14	2,46	3,72	9,55	2,54	3,76	10,0	2,69	3,73
	25	7,04	2,18	3,23	7,66	2,31	3,32	8,22	2,47	3,33	8,96	2,61	3,43	9,34	2,70	3,46	9,78	2,86	3,42
M 1500 m <sup>3</sup> /h	10	-	-	-	8,67	1,46	5,94	9,48	1,53	6,20	10,4	1,60	6,49	11,0	1,64	6,71	11,7	1,68	6,96
	15	-	-	-	8,56	1,65	5,19	9,34	1,72	5,43	10,1	1,79	5,65	10,7	1,84	5,79	11,3	1,88	6,00
	18	7,71	1,67	4,62	8,52	1,74	4,90	9,30	1,82	5,11	9,94	1,91	5,20	10,4	1,97	5,30	11,0	2,02	5,44
	20	7,70	1,73	4,45	8,49	1,80	4,72	9,28	1,88	4,94	9,83	1,99	4,94	10,3	2,05	5,02	10,8	2,11	5,11
	22	7,55	1,80	4,19	8,28	1,89	4,38	9,03	1,97	4,58	9,67	2,07	4,67	10,2	2,14	4,74	10,6	2,20	4,83
(Std)	25	7,35	1,92	3,83	8,02	2,01	3,99	8,71	2,11	4,13	9,45	2,21	4,28	10,0	2,28	4,36	10,5	2,37	4,41
H 2500 m <sup>3</sup> /h	10	-	-	-	8,84	1,24	7,13	-	-	-	-	-	-	-	-	-	-	-	-
	15	-	-	-	8,77	1,42	6,18	9,63	1,45	6,64	10,5	1,48	7,11	11,2	1,51	7,40	12,0	1,52	7,88
	18	-	-	-	8,77	1,52	5,77	9,64	1,55	6,22	10,4	1,60	6,49	11,0	1,63	6,76	11,8	1,65	7,12
	20	7,91	1,53	5,17	8,76	1,58	5,54	9,67	1,63	5,93	10,3	1,68	6,12	10,9	1,72	6,34	11,6	1,74	6,66
	22	7,79	1,61	4,84	8,59	1,66	5,17	9,42	1,71	5,51	10,2	1,77	5,73	10,8	1,80	5,98	11,4	1,84	6,18
	25	7,63	1,72	4,44	8,37	1,77	4,73	9,11	1,83	4,98	10,0	1,89	5,26	10,5	1,92	5,47	11,1	1,97	5,62

Performances referred to three air flows available

kWt = Heating capacity in kW. (gross)

kWe = Electrical power absorbed by compressor in kW

COP = Referred to compressors only

The heating capacities have not accounted for the heat dissipation of the fan motors.

Airflow:

L = Low Extraquiet

M = Medium Quiet

H = High Powerful

Std = Standard airflow referred to the general technical data.



# General technical data

## Performance in Heating

### Size 5.1

Air flow rate	Water outlet temperature [°C]	5			9			13			17			19			25		
	Room temperature D.B. [°C]	kWt	kWe	COP	kWt	kWe	COP	kWt	kWe	COP	kWt	kWe	COP	kWt	kWe	COP	kWt	kWe	COP
2200 m <sup>3</sup> /h L	10	-	-	-	11,4	2,03	5,60	12,6	2,07	6,08	13,8	2,13	6,47						
	15	-	-	-	11,3	2,31	4,87	12,4	2,39	5,18	13,6	2,45	5,54	14,3	2,49	5,75	15,2	2,53	6,02
	18	10,1	2,40	4,22	11,1	2,47	4,51	12,2	2,57	4,76	13,4	2,63	5,08	14,1	2,68	5,25	14,9	2,74	5,44
	20	10,0	2,51	4,00	11,0	2,58	4,28	12,1	2,69	4,51	13,2	2,75	4,80	13,9	2,81	4,95	14,7	2,87	5,11
	22	10,0	2,61	3,82	10,9	2,70	4,05	12,0	2,80	4,28	13,0	2,88	4,52	13,7	2,94	4,67	14,4	3,01	4,79
2800 m <sup>3</sup> /h M (Std)	10	-	-	-	11,4	1,88	6,06	-	-	-	-	-	-	-	-	-	-	-	-
	15	-	-	-	11,3	2,16	5,23	12,5	2,21	5,65	13,7	2,23	6,16	-	-	-	-	-	-
	18	-	-	-	11,2	2,33	4,82	12,4	2,39	5,17	13,6	2,43	5,59	14,4	2,48	5,79	15,3	2,50	6,10
	20	10,1	2,38	4,26	11,2	2,44	4,57	12,3	2,51	4,89	13,5	2,56	5,26	14,2	2,61	5,44	15,1	2,63	5,73
	22	10,1	2,48	4,06	11,1	2,56	4,32	12,2	2,63	4,62	13,3	2,70	4,92	14,0	2,74	5,11	14,8	2,78	5,33
3800 m <sup>3</sup> /h H (Std)	10	-	-	-	11,5	1,74	6,59	-	-	-	-	-	-	-	-	-	-	-	-
	15	-	-	-	11,4	2,02	5,63	12,6	2,02	6,23	-	-	-	-	-	-	-	-	-
	18	-	-	-	11,3	2,19	5,17	12,5	2,22	5,63	-	-	-	-	-	-	-	-	-
	20	10,2	2,27	4,48	11,3	2,31	4,88	12,4	2,35	5,29	13,6	2,38	5,72	14,5	2,39	6,05	15,4	2,41	6,39
	22	10,1	2,37	4,28	11,2	2,43	4,61	12,3	2,47	4,98	13,5	2,51	5,37	14,3	2,52	5,67	15,2	2,55	5,96
25	10,1	2,52	3,99	11,1	2,59	4,28	12,1	2,65	4,58	13,3	2,70	4,93	14,0	2,71	5,18	14,9	2,74	5,43	

### Size 7.1

Air flow rate	Water outlet temperature [°C]	5			9			13			17			19			25		
	Room temperature D.B. [°C]	kWt	kWe	COP	kWt	kWe	COP	kWt	kWe	COP	kWt	kWe	COP	kWt	kWe	COP	kWf	kWe	COP
2200 m <sup>3</sup> /h L	10	-	-	-	18,8	3,60	5,22	20,6	3,71	5,56	22,5	4,03	5,57	23,7	4,25	5,57	25,5	4,55	5,59
	15	-	-	-	18,4	4,07	4,51	20,0	4,23	4,73	21,7	4,52	4,81	23,0	4,73	4,86	24,8	5,05	4,90
	18	-	-	-	18,4	4,39	4,20	19,8	4,58	4,31	21,5	4,86	4,42	22,9	5,07	4,52	-	-	-
	20	17,0	4,35	3,91	18,6	4,61	4,04	19,7	4,82	4,08	-	-	-	-	-	-	-	-	-
	22	16,6	4,56	3,63	18,1	4,82	3,76	-	-	-	-	-	-	-	-	-	-	-	-
2800 m <sup>3</sup> /h M (Std)	10	-	-	-	19,1	3,22	5,92	21,1	3,34	6,31	23,1	3,59	6,42	24,5	3,78	6,48	26,6	4,04	6,57
	15	-	-	-	18,7	3,69	5,07	20,5	3,79	5,41	22,3	4,04	5,53	23,6	4,22	5,60	25,5	4,49	5,67
	18	-	-	-	18,8	3,98	4,71	20,3	4,14	4,90	21,9	4,35	5,04	23,2	4,52	5,13	25,0	4,77	5,25
	20	-	-	-	18,9	4,17	4,54	20,2	4,39	4,61	21,7	4,56	4,75	22,9	4,72	4,85	-	-	-
	22	16,8	4,15	4,05	18,4	4,38	4,21	19,9	4,55	4,37	-	-	-	-	-	-	-	-	-
3800 m <sup>3</sup> /h H (Std)	10	-	-	-	19,3	2,89	6,68	21,4	2,97	7,22	23,6	3,16	7,46	25,3	3,31	7,63	27,8	3,55	7,82
	15	-	-	-	19,1	3,28	5,81	21,1	3,37	6,26	23,0	3,57	6,45	24,6	3,74	6,57	26,7	3,98	6,71
	18	-	-	-	19,2	3,56	5,39	20,9	3,67	5,69	22,6	3,84	5,89	24,1	4,00	6,02	26,1	4,24	6,15
	20	-	-	-	19,4	3,76	5,15	20,7	3,89	5,32	22,3	4,03	5,53	23,7	4,19	5,66	25,7	4,41	5,82
	22	17,2	3,75	4,58	18,8	3,94	4,78	20,4	4,06	5,01	22,1	4,23	5,21	23,4	4,40	5,32	25,3	4,63	5,46
25	16,6	4,05	4,11	18,2	4,23	4,30	19,9	4,33	4,60	21,6	4,55	4,76	23,0	4,72	4,86	-	-	-	

Performances referred to three air flows available

kWt = Heating capacity in kW. (gross)

kWe = Electrical power absorbed by compressor in kW

COP = Referred to compressors only

The heating capacities have not accounted for the heat dissipation of the fan motors.

Airflow:

L = Low Extraquiet

M = Medium Quiet

H = High Powerful

Std = Standard airflow referred to the general technical data.

# General technical data

## Performance in Heating

### Size 10.1

Air flow rate	Water outlet temperature[°C]	5			9			13			17			19			25		
	Room temperature D.B. [°C]	kWt	kWe	COP	kWt	kWe	COP	kWt	kWe	COP	kWt	kWe	COP	kWt	kWe	COP	kWt	kWe	COP
3700 m <sup>3</sup> /h L	10	-	-	-	28,0	4,93	5,68	31,0	5,26	5,88	33,6	5,58	6,03	35,6	5,81	6,12	38,2	6,08	6,27
	15	-	-	-	27,4	5,45	5,03	30,1	5,74	5,24	32,6	6,10	5,34	34,3	6,31	5,44	36,7	6,62	5,54
	18	-	-	-	26,7	5,82	4,59	29,0	6,07	4,78	32,0	6,43	4,97	33,6	6,65	5,05	35,9	6,98	5,15
	20	-	-	-	26,2	6,08	4,31	28,2	6,29	4,48	31,6	6,66	4,74	33,2	6,89	4,82	35,5	7,24	4,91
	22	23,6	5,89	4,01	26,1	6,24	4,18	28,0	6,55	4,28	31,2	6,88	4,53	32,9	7,15	4,60	-	-	-
	25	23,3	6,17	3,77	25,8	6,53	3,95	27,7	6,93	3,99	30,7	7,27	4,22	-	-	-	-	-	-
4200 m <sup>3</sup> /h M	10	-	-	-	28,3	4,73	5,99	31,2	5,01	6,24	34,1	5,30	6,44	36,2	5,51	6,58	39,1	5,80	6,73
	15	-	-	-	27,7	5,19	5,34	30,5	5,51	5,53	33,2	5,80	5,72	34,9	6,02	5,80	37,4	6,32	5,92
	18	-	-	-	27,1	5,57	4,87	29,4	5,84	5,03	32,6	6,13	5,31	34,2	6,35	5,39	36,6	6,66	5,49
	20	-	-	-	26,6	5,85	4,55	28,5	6,06	4,70	32,1	6,36	5,05	33,8	6,58	5,14	36,1	6,89	5,23
	22	23,9	5,71	4,19	26,5	5,99	4,42	28,4	6,27	4,52	31,7	6,59	4,81	33,4	6,82	4,89	35,7	7,14	5,00
	25	23,6	6,03	3,91	26,2	6,32	4,14	28,0	6,69	4,19	31,1	7,04	4,42	32,9	7,27	4,52	-	-	-
4900 m <sup>3</sup> /h H (Std)	10	-	-	-	28,5	4,50	6,33	31,5	4,76	6,61	34,7	5,03	6,89	36,8	5,22	7,05	40,1	5,51	7,27
	15	-	-	-	28,0	4,99	5,61	30,9	5,25	5,89	33,6	5,54	6,06	35,7	5,73	6,24	38,4	6,00	6,40
	18	-	-	-	27,4	5,35	5,12	29,9	5,56	5,37	33,0	5,84	5,65	35,0	6,04	5,79	37,5	6,31	5,94
	20	-	-	-	26,9	5,59	4,81	28,9	5,78	4,99	32,6	6,05	5,39	34,5	6,25	5,52	36,9	6,53	5,64
	22	24,2	5,49	4,40	26,8	5,75	4,66	28,8	6,00	4,80	32,3	6,28	5,14	34,0	6,49	5,24	36,4	6,78	5,36
	25	23,8	5,74	4,14	26,6	6,02	4,41	28,5	6,34	4,50	31,6	6,64	4,76	33,3	6,86	4,86	35,7	7,16	4,99

### Size 12.1 - Outdoor air percentage: 0%

Air flow rate	Water outlet temperature[°C]	5			9			13			17			19			25		
	Room temperature D.B. [°C]	kWt	kWe	COP	kWt	kWe	COP	kWt	kWe	COP	kWt	kWe	COP	kWt	kWe	COP	kWt	kWe	COP
6000 m <sup>3</sup> /h M (Std)	10	-	-	-	32,4	4,55	7,11	35,3	4,87	7,24	38,5	5,09	7,56	41,4	5,35	7,73	45,3	5,81	7,80
	15	-	-	-	32,1	5,06	6,33	34,6	5,34	6,49	37,9	5,65	6,71	40,5	5,91	6,86	44,1	6,37	6,92
	18	-	-	-	31,9	5,55	5,75	34,1	5,71	5,98	37,2	6,01	6,20	39,7	6,26	6,35	43,3	6,75	6,42
	20	-	-	-	31,8	5,94	5,36	33,7	5,97	5,65	36,7	6,24	5,88	39,2	6,50	6,02	42,9	7,01	6,12
	22	-	-	-	31,2	6,05	5,16	33,5	6,20	5,40	36,3	6,50	5,59	38,6	6,78	5,69	42,3	7,28	5,81
	25	27,9	6,05	4,60	30,5	6,31	4,83	33,1	6,59	5,02	35,7	6,92	5,16	37,9	7,22	5,24	41,5	7,74	5,36
7000 m <sup>3</sup> /h H	10	-	-	-	32,3	4,34	7,44	35,8	4,80	7,45	38,9	4,84	8,04	41,7	5,09	8,19	46,1	5,51	8,36
	15	-	-	-	32,0	4,85	6,60	35,0	5,10	6,87	38,3	5,38	7,12	40,9	5,62	7,28	45,0	6,06	7,43
	18	-	-	-	32,1	5,32	6,03	34,6	5,46	6,33	37,8	5,72	6,60	40,3	5,97	6,76	44,2	6,41	6,89
	20	-	-	-	32,2	5,69	5,66	34,2	5,72	5,98	37,4	5,94	6,29	39,9	6,21	6,43	43,6	6,65	6,55
	22	-	-	-	31,6	5,79	5,46	33,9	5,95	5,69	37,0	6,22	5,94	39,3	6,46	6,08	42,9	6,92	6,20
	25	27,9	5,83	4,79	30,9	6,03	5,12	33,3	6,31	5,28	36,3	6,62	5,48	38,4	6,85	5,61	42,0	7,33	5,73

Performances referred to three air flows available

kWt = Heating capacity in kW. (gross)

kWe = Electrical power absorbed by compressor in kW

COP = Referred to compressors only

The heating capacities have not accounted for the heat dissipation of the fan motors.

Airflow:

L = Low Extraquiet

M = Medium Quiet

H = High Powerful

Std = Standard airflow referred to the general technical data.

## Option compatibility

REF	DESCRIPTION	
<b>Aeraulic circuit</b>		
APFLX	Filter holder with access from the lower side	◊
<b>Hydraulic circuit</b>		
CDPX	Condensate drain pump	◊
VIFWX	Steel mesh strainer and hand shut-off valve	◊
FCVBX	Water balancing valve	◊
V2ONX	2-way ON-OFF valve for variable flow-rate loop	◊
BPH2OX	Shut-off valve for by-pass (water side)	◊
V2MANX	Two-way manually actuated valves for constant water flow loop	◊
V2MODX	2-way modulating valve for disposable water system.	◊
FLOX	Water control flow switch	◊
<b>Electric circuit</b>		
MOBX	Modbus RS 485 serial port kit	◊
CMSLWX	LonWorks serial communication module	◊
BACX	BACnet serial communication module	◊
CWMX	Electronic room control with display, for wall installation	◊
CIWMX	Electronic room control with display, for wall installation in built-in box	◊
<b>Installation</b>		
AMMX	Spring antivibration mounts	◊
PCFM0	Panels with M0 reaction to fire class	0

○ Optional component

◊ Accessory separately supplied (optional)

# Dimensional drawings

## Size 2.1 - 3.1

DAA7O0001\_2.1\_3.1\_1\_REV01  
DATA/DATE 12/06/2019

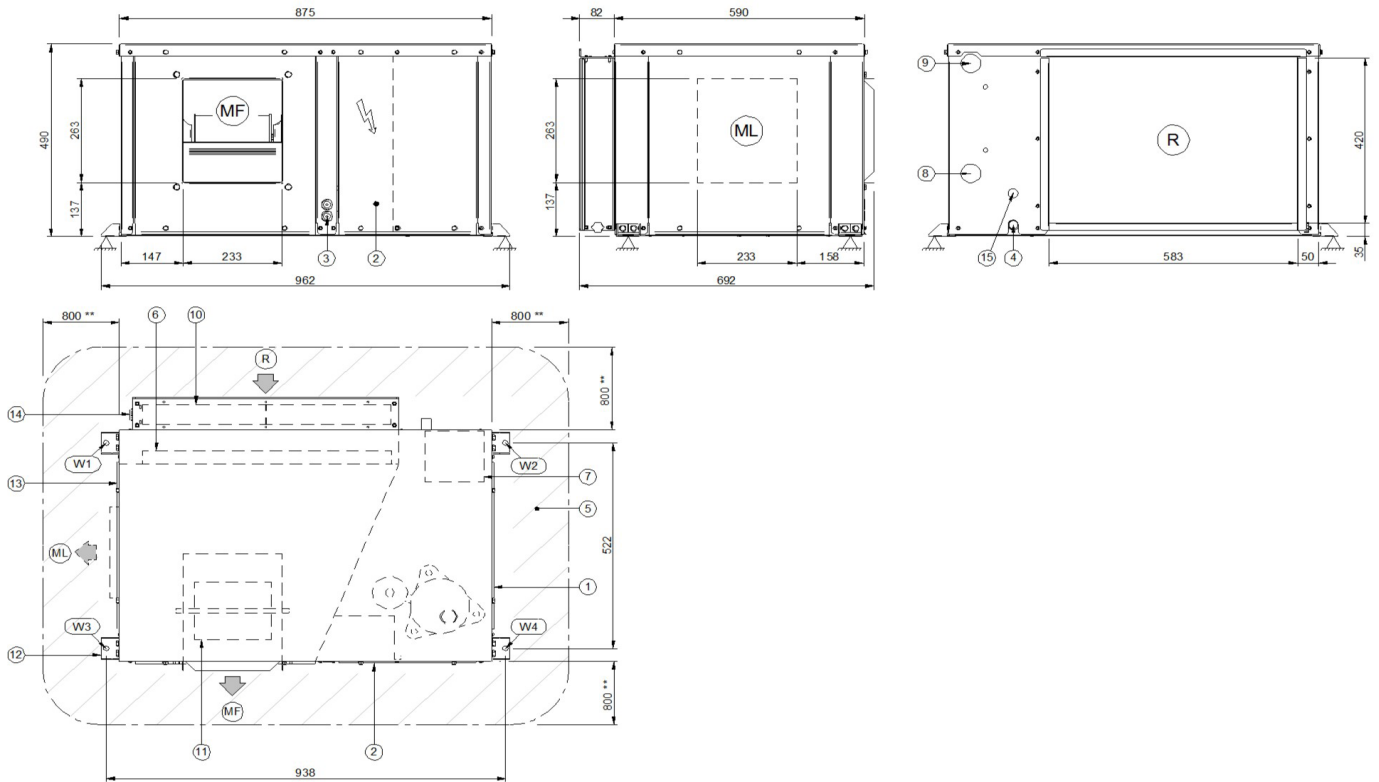

1. Compressor enclosure
  2. Electrical panel
  3. Power input
  4. Condensate drain (provide a drain trap)
  5. Respect functional spaces
  6. Treatment coil
  7. Plate exchanger
  8. Plate exchanger water input 1"
  9. Plate exchanger water output 1"
  10. Air filters
  11. Electric fan (supply-return)
  12. Lifting bracket
  13. Coil - electric fan inspection
  14. Filter extraction: from the side
  15. Hydraulic circuit valve connection
- (R) Air inlet  
(MF) Front air supply  
(ML) Lateral air supply  
(\*\*) Minimum suggested clearance

Size	2.1	3.1
Lenght	962	962
Height	490	490
Depth	692	692
Operation weight	98	103
Shipping weight	102	107

The presence of optional accessories may result in a substantial variation of the weights shown in the table.

# Dimensional drawings

## Size 5.1 - 7.1

DAA700001\_5.1\_7.1\_1\_REV01  
DATA/DATE 12/06/2019

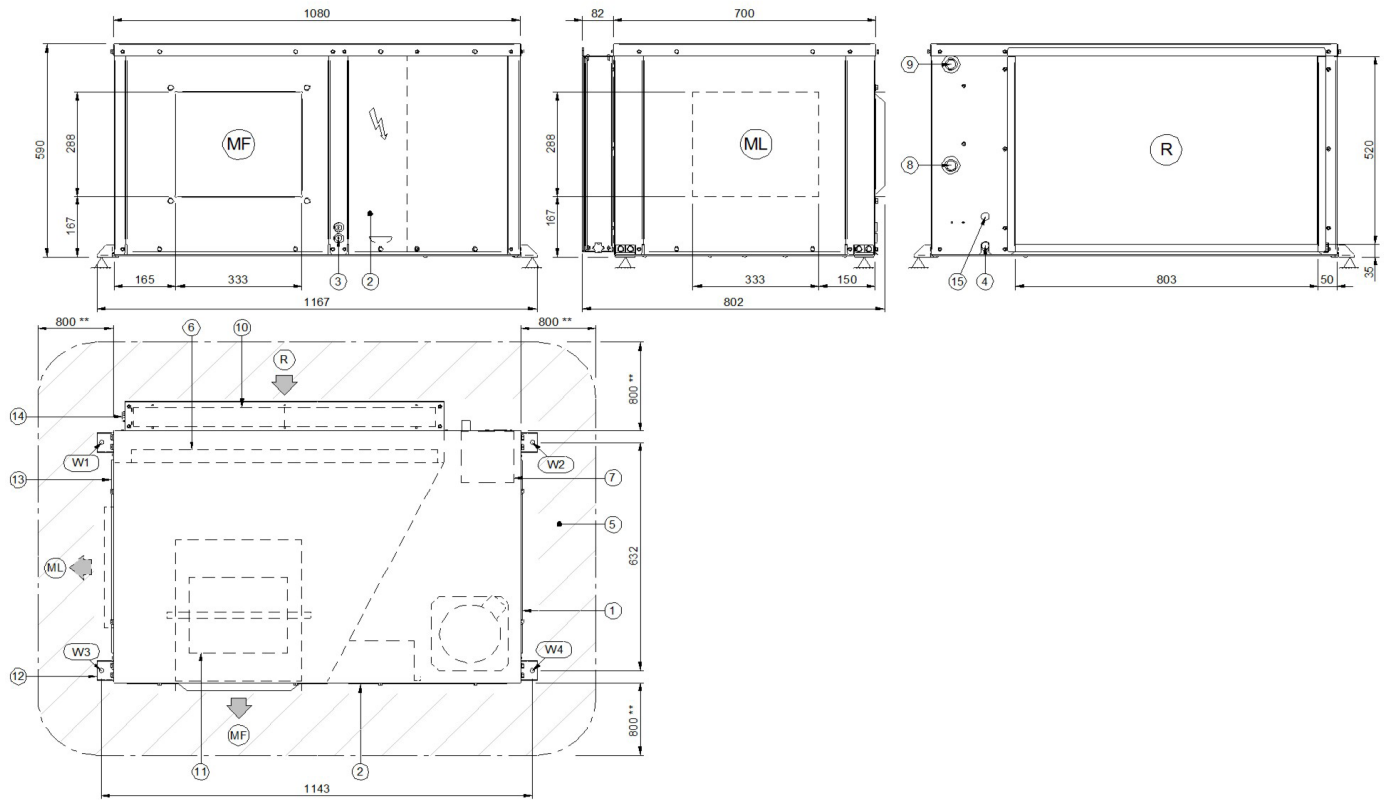

1. Compressor enclosure
  2. Electrical panel
  3. Power input
  4. Condensate drain (provide a drain trap)
  5. Respect functional spaces
  6. Treatment coil
  7. Scambiatore a piastre
  8. Plate exchanger water input 1"
  9. Plate exchanger water output 1"
  10. Air filters
  11. Electric fan (supply-return)
  12. Lifting bracket
  13. Coil - electric fan inspection
  14. Filter extraction: from the side
  15. Hydraulic circuit valve connection
- (R) Air inlet  
(MF) Front air supply  
(ML) Lateral air supply  
(\*\*) Minimum suggested clearance

Size	5.1	7.1
Lenght	1167	1167
Height	590	590
Depth	802	802
Operation weight	138	151
Shipping weight	143	156

The presence of optional accessories may result in a substantial variation of the weights shown in the table.

# Dimensional drawings

## Size 10.1 - 12.1

DAA7O0003\_10.1\_12.1\_1\_REV03  
DATA/DATE 26/07/2019

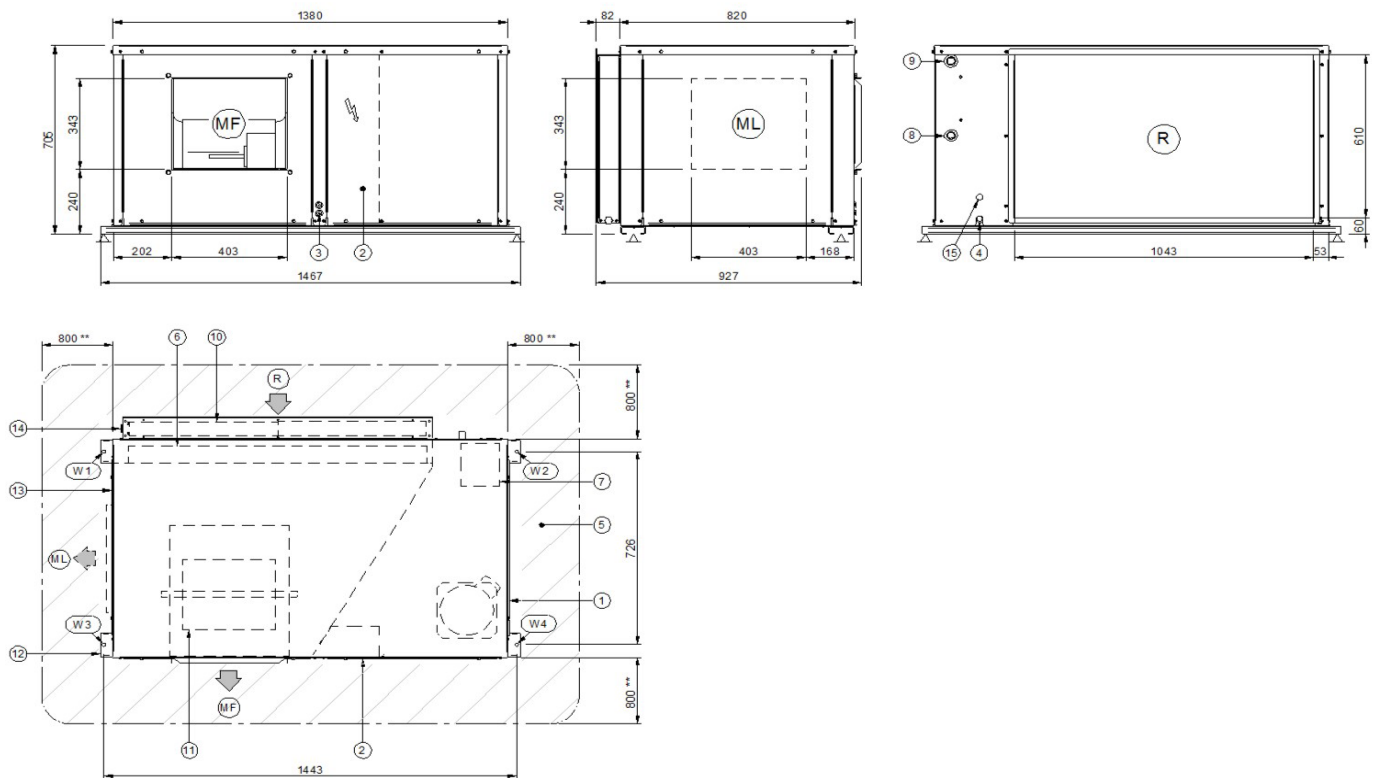

1. Compressor enclosure
2. Electrical panel
3. Power input
4. Condensate drain (provide a drain trap)
5. Respect functional spaces
6. Treatment coil
7. Plate exchanger
8. Plate exchanger water input 1"1/2"
9. Plate exchanger water output 1"1/2"
10. Air filters
11. Electric fan (supply-return)
12. Lifting bracket
13. Coil - electric fan inspection
14. Filter extraction: from the side
15. Hydraulic circuit valve connection
- (R) Air inlet
- (MF) Front air supply
- (ML) Lateral air supply
- (\*\*) Minimum suggested clearance

Size	10.1	12.1
Lenght	1467	1467
Height	705	705
Depth	927	927
Operation weight	200	225
Shipping weight	225	250

The presence of optional accessories may result in a substantial variation of the weights shown in the table.

Page intentionally left blank



Page intentionally left blank

Page intentionally left blank

FOR OVER 35 YEARS WE HAVE BEEN  
OFFERING SOLUTIONS TO ENSURE  
SUSTAINABLE COMFORT AND THE WELL-  
BEING OF PEOPLE AND THE ENVIRONMENT

[www.clivet.com](http://www.clivet.com)

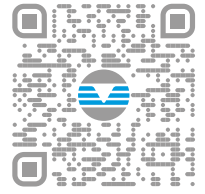

sale and assistance

Valid from: 2019- (revision 03/2025)  
BT191015GB-03



**CLIVET S.p.A.**

Via Camp Lonc 25, Z.I. Villapaiera 32032 - Feltre (BL) - Italy  
Tel. +39 0439 3131 - [info@clivet.it](mailto:info@clivet.it)

**CLIVET GMBH**

Hummelsbütteler Steindamm 84,  
22851 Norderstedt, Germany  
Tel. +49 40 325957-0 - [info.de@clivet.com](mailto:info.de@clivet.com)

**Clivet Group UK LTD**

Units F5 & F6 Railway Triangle,  
Portsmouth, Hampshire PO6 1TG  
Tel. +44 02392 381235 -  
[Enquiries@Clivetgroup.co.uk](mailto:Enquiries@Clivetgroup.co.uk)

**CLIVET LLC**

Office 508-511, Elektrozavodskaya st. 24,  
Moscow, Russian Federation, 107023  
Tel. +7495 6462009 - [info.ru@clivet.com](mailto:info.ru@clivet.com)

**CLIVET MIDEAST FZCO**

Dubai Silicon Oasis (DSO) Headquarter Building,  
Office EG-05, P.O Box-342009, Dubai, UAE  
Tel. +9714 3208499 - [info@clivet.ae](mailto:info@clivet.ae)

**Clivet South East Europe d.o.o.**

Jarušćica 9b  
10000, Zagreb, Croatia  
Tel. +3851 222 8784 - [info.see@clivet.com](mailto:info.see@clivet.com)

**CLIVET France SAS**

6 Allée Kepler,  
77420 Champs-sur-Marne  
France  
mail: [info.fr@clivet.com](mailto:info.fr@clivet.com)  
Tel: +33 01 88 60 99 40

**Clivet Airconditioning Systems Pvt Ltd**

Office No.501 & 502,5th Floor, Commercial -I,  
Kohinoor City, Old Premier Compound, Off LBS  
Marg, Kirool Road, Kurla West, Mumbai  
Maharashtra 400070, India  
Tel. +91 22 30930200 - [sales.india@clivet.com](mailto:sales.india@clivet.com)