



Air cooled reversible full inverter heat pump for outdoor installation

Large EVO

WiSAN-YEE1 45.4-85.4 RANGE

TECHNICAL BULLETIN



SIZE	45.4	50.4	55.4	60.4	65.4	70.4	75.4	80.4	85.4
COOLING CAPACITY KW	115	127	139	152	164	176	196	215	233
HEATING CAPACITY KW	118	130	150	170	190	210	230	250	268

Sommario

3	Features and benefits
5	Standard unit technical features
7	Unit configuration
8	Built-in options
10	Accessories supplied separately
11	General technical data
12	General technical data
28	Configurations
30	Accessories - Hydronic assembly
46	Features and options
50	Modularity and management of cascade units
52	Management mode
53	Management of auxiliary heat sources
56	Dimensional drawings



Clivet participates in the ECP Programme for “Liquid Chillers and Hydronic Heat Pumps”.
Check ongoing validity of certificate on www.eurovent-certification.com”

Features and benefits

LARGE EVO is the new generation of air cooled liquid chillers and heat pumps, equipped with Full DC Inverter technology and R-32 refrigerant with low environmental impact, designed for outdoor installation.

WiSAN-YEE1

Air cooled reversible heat pump with full DC inverter technology and R-32 refrigerant

- Range 115 ÷ 233 kW
- Seasonal efficiency (SCOP) up to 4,22
- Seasonal efficiency (SEER) up to 4.51
- Operating with 48°C of outdoor air temperature in cooling
- Operating with -20°C of outdoor air temperature in heating
- Hot water production up to 60°C
- Copper/aluminum condensing coil
- Partial recovery of the condensing heat
- Plate exchanger
- 2 refrigeration circuits



The heat pump version of the LARGE EVO is available from 115 kW up to 233 kW.

Its high seasonal efficiency together with its wide operating limits make it the ideal solution for many types of installation, being at the same time the most effective and valuable solution both in terms of capital investment and running costs.

Energy Efficiency

SCOP up to 4,22 with low water temperature (LWT 35°C).

SEER up to 4,51, which makes it extremely competitive even compared to cooling only units.

Capacity modulation from 20% to 100%.

Extensive operating limits

Outdoor temperature	max	min
heating	44°C	-20°C
Production of domestic hot water	44°C	-20°C
Cooling	48°C	-15°C

Outlet water temperature	max	min
heating	60°C	25°C
Production of domestic hot water	60°C	25°C
Cooling	20°C	0°C

Mode

- Management and production of domestic hot water up to 60°C.
- Climatic compensation with external temperature
- Double set-point management
- Auxiliary generator management
- SG Ready
- EVU lock ready (remote on/off)
- Demand limit

Acoustic configuration

Three sound configurations levels:

- Standard acoustic configuration
- Silenced acoustic configuration (-4 dB(A))
- Super-silenced acoustic configuration (-8 dB(A))

Application versatility

All the main system components are supplied on the unit, ensuring maximum manufacturing reliability and easy installation:

- Hydropack with 1 inverter pump, low or high head
- Hydropack with 1 on/off pump, low or high head
- Hydropack with 2 inverter pumps in duty/stand-by configuration, low or high head
- Hydropack with 2 on/off pumps in duty/stand-by configuration, low or high head
- 3-way valve for domestic hot water management
- System storage tank
- Partial energy recovery
- Drain pan with electric heater

Cascade management

LARGE EVO is designed to connect up to 8 units in a local network, reaching a maximum unit capacity of 1864 kW.

Standard unit technical features

Compressor

Size 45.4 - 50.4

Inverter-controlled rotary hermetic compressor fitted with a motor protection device for overheating, overcurrents and excessive temperatures of the supply gas. It is installed on rubber anti-vibration mounts and comes with a full oil charge. The compressor is wrapped in a sound-absorbing hood, that reduces its sound emissions. A crankcase heater with automatic activation prevents the refrigerant from diluting the oil when the compressor stops.

Size 55.4 - 60.4

Circuit 1

Inverter-controlled rotary hermetic compressor fitted with a motor protection device for overheating, overcurrents and excessive temperatures of the supply gas. It is installed on rubber anti-vibration mounts and comes with a full oil charge. The compressor is wrapped in a sound-absorbing hood, that reduces its sound emissions. A crankcase heater with automatic activation prevents the refrigerant from diluting the oil when the compressor stops.

Circuit 2

Inverter-controlled hermetic Scroll compressor with steam injection fitted with a motor protection device for overheating, overcurrents and excessive temperatures of the supply gas. It is installed on rubber antivibration mounts and comes with a full oil charge. The compressor has a sound blanket, that reduces its sound emissions and thermally insulates it

Size 65.4 - 85.4

Inverter-controlled hermetic Scroll compressor with steam injection fitted with a motor protection device for overheating, overcurrents and excessive temperatures of the supply gas. It is installed on rubber antivibration mounts and comes with a full oil charge. The compressor has a sound blanket, that reduces its sound emissions and thermally insulates it.

Structure

Supporting structure and base made entirely of sturdy sheet steel, 12/10 thick, with hot-dip galvanised surface treatment and parts in full view painted with polyester powder RAL9001, which guarantees excellent mechanical characteristics and high corrosion resistance over time.

Panelling

External panelling made of sheet steel, 12/10 thick, with hot-dip galvanised surface treatment and painted with polyester powder RAL9001 that guarantees greater corrosion resistance in outdoor installations and eliminates the need for periodic painting. The panels can be easily removed to fully access internal components.

Internal exchanger

Direct expansion heat exchanger, braze-welded AISI 316 stainless steel plates, in pack without gaskets using copper as the brazing material, with low refrigerant content and large exchange surface, complete with:

- 17 mm thick external no-condensation thermal insulation in sintered expanded polypropylene;
- antifreeze heater to protect the water side exchanger to prevent ice from forming if the water temperature drops below the pre-set value.

External exchanger

Direct expansion finned coil exchanger made with copper pipes placed on staggered rows mechanically expanded to better adhere to the fin collar. The fins are made of hydrophilic aluminium and properly spaced for maximum heat exchange efficiency. A particular refrigerant circuit prevents ice from forming on the base of the exchanger during winter operation.

Fan

Axial fans with sickle-shaped blades made of ABS ASG-20 resin reinforced with 20% glass fibre, directly coupled to the electronically controlled motor (IP23), driven by the continuous magnetic switching of the stator. The brushless technology and the special power supply increase both the lifecycle and the efficiency. Consumption is thus reduced by as much as 50%.

The fans are housed in aerodynamically shaped nozzles to increase efficiency and minimise noise levels and are fitted with accident prevention grilles. Both fans and grilles are designed with CFD technology. Supplied with variable speed control.

Refrigeration circuit

Two independent refrigeration circuits made of copper, brazed and factory-assembled, complete with:

- electronic expansion valve;
- 4-way reverse cycle valve;
- safety high pressure switch,
- low pressure safety switch;
- liquid receiver;
- oil separator;
- High pressure transducer
- safety thermostat against compressor drain overheating;
- Temperature sensors
- suction separator.
- low pressure safety valve

Size 55.4 - 85.4

- economizer exchanger

Electrical panel

The Power Section includes:

- main disconnecting switch;
- general protection fuses;
- insulation transformer to power the auxiliary circuit;
- auxiliary component protection fuses;
- AC filter on power supply
- Power supply phase sequence protection
- Protection for compressor over current
- Protection for compressor overload
- Sensor malfunction protection
- phase monitor

The control section includes:

- compressor timing and protection;
- Relay for remote cumulative fault signal
- Defrosting cycle optimization
- Condenser control
- dry contact for remote on-off control;
- dry contact for auxiliary generator management.

The control keypad includes:

- wired controller with dot-matrix display;
- Multifunction keys for ON/OFF control
- Cold, hot and auto operation mode
- alarms display and reset,
- Daily or weekly schedule
- power output for remote control;
- serial port with Modbus outlet (RS 485) for remote communication.

Water circuit

- Temperature sensors;
- drain valve;
- antifreeze heaters to protect the water side exchanger to prevent ice from forming if the water temperature drops below the pre-set value;
- differential pressure switch, water side;
- relief valve.

Test

Unit subjected to factory-tested in specific steps and test pressure of the piping of the refrigerant circuit (with nitrogen and hydrogen), before shipping them.

Unit equipment with low outdoor temperatures

MINIMUM OUTDOOR AIR TEMPERATURE		OPERATING UNIT		UNIT IN STAND-BY ⁽⁵⁾ (fed unit)	UNIT IN STORAGE (unit not fed)
		COOLING*	HEATING*		
+11°C	1	✓STANDARD UNIT		✓STANDARD UNIT	✓STANDARD UNIT ⁽⁶⁾
+2°C	2				
-5°C	4				
-7°C	3				
-10°C	4		✓STANDARD UNIT		
From -10°C to -15°C			✓STANDARD UNIT		
From -15°C to -20°C		NOT POSSIBLE		✓ WATER EMPTY UNIT OR WITH AN APPROPRIATE GLYCOL PERCENTAGE	NOT POSSIBLE
From -20°C to -30°C			NOT POSSIBLE	✓ WATER EMPTY UNIT OR WITH AN APPROPRIATE GLYCOL PERCENTAGE ✗ NOT SUITABLE: BUILT-IN PUMPS	

Data referred to the following conditions:

*production of chilled water:

internal exchanger water = 12/7°C

**Production of hot water:

internal exchanger water = 30/35 °C

1. Part load unit and air speed equal to 1 m/s.
2. Part load unit and air speed equal to 0.5 m/s.
3. Part load unit and outdoor air temperature at rest.
4. Unit at full load and outdoor air temperature at rest.

⁽⁵⁾ The water pumping unit must be fed and connected to the unit according to the manual.

⁽⁶⁾ Unit without water or containing water with an appropriate quantity of glycol.

At the unit start-up the water temperature or water with glycol must be inside the operating range indicated in the "Operating range" graph.

To know the water freezing temperature on varying the glycol percentage refer to the specific 'Correction factors for glycol use' table.

⚠ Air conditions which are at rest are defined as the absence of air flowing towards the unit. Weak winds can induce air to flow through the exchanger and air-levels which can cause a reduction in the operating range.

In the presence of predominant winds it is necessary to use suitable windbreak barriers.

⚠ The unit, with an average external air temperature below -10 °C, can be stored for a maximum of 1 month.

Unit configuration

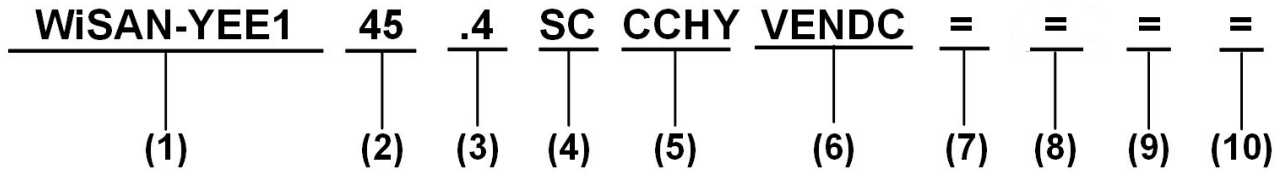

(1) Range

WiSAN = Air cooled reversible heat pump with inverter compressors

(2) Size

45 = Nominal compressor capacity (HP)

(3) Compressors

.4 = Compressor quantity

(4) Acoustic configuration

SC = Acoustic configuration with compressor soundproofing

LN = Silenced acoustic configuration

EN = Super-silenced acoustic configuration

(5) Condensing coil

CCHY = Copper / aluminium condenser coil with hydrophilic treatment (Standard)

CCCA = Copper / aluminium condenser coil with acrylic lining

CCCA1 = Copper / aluminium condensing coils with Aluminium Energy Guard DCC treatment

(6) Fans

VENDC = DC high efficiency fans (standard)

(7) Pumping unit

(-) not required (standard)

1PM = Hydropack with N° 1 pump

1PMH = Hydropack with N° 1 high static pressure pump

1PMV = Hydropack with N° 1 inverter pump

1PMVH = Hydropack with N° 1 high static pressure inverter pump

1P1SB = Hydropack with N° 1 pump + N° 1 in stand-by

1PAP+S = Hydropack with N° 1 high static pressure pump + N° 1 in stand-by pump

1P1SBV = Hydropack with N° 1 inverter pump and N° 1 stand-by pump with dedicated inverter

1PAPSV = Hydropack with 1 high head inverter pump and 1 stand-by pump with dedicated inverter

(8) Storage tank

(-) not required (standard)

ACC = Storage tank

(9) Energy recovery

(-) not required (standard)

D = Partial energy recovery

(10) Domestic hot water valve

(-) Not required (standard)

VACS = DHW switching valve

ACC Storage tank
 Steel storage tank complete with double layer covering with closed-cell insulation, stainless steel anti-freeze immersion resistance, bleed valve, draw off cock, cast-iron shut-off butterfly valve with quick connections and activation lever with a mechanical calibration lock at the evaporator output, quick connections with insulated casing.
 The water tank capacity is 300 litres for sizes 45.4 to 60.4.
 The water tank capacity is 500 litres for sizes 65.4 to 85.4.
 The device is installed and wired on the unit and is located on the system's return line.

CMSC13 Serial communication module ModBus TCP/IP, BACnet/IP, BACnet MS/TP
 This enables the serial connection of the supervision system, using ModBus TCP/IP, BACnet/IP, BACnet MS/TP as the communication protocol. It enables access to the complete list of operational variables, commands and alarms. Using this accessory every unit can dialogue with the main supervision systems.
 The device is installed and wired on the unit.

- ⚠ The configuration and management activities for the BACnet networks are the responsibility of the client
- ⚠ The total length of each individual serial line must not exceed 1000 m and the line must be connected in bus type (input/output).

VACS DHW switching valve
 The switching valve that diverts the water flow to a heating water tank for domestic water is installed on the unit.
 If the DHW temperature falls below the set-point, Large EVO switches to DHW production mode (priority over other operating modes can be set).
 The unit controller closes a digital output driving the flow deviation valve from the storage system until it reaches the ACS set-point set on the user interface.
 The water connections are 2" 1/2 Victaulic for sizes 45.4÷60.4 and 3" for sizes 65.4÷85.4.

DHW switching valve pressure drop

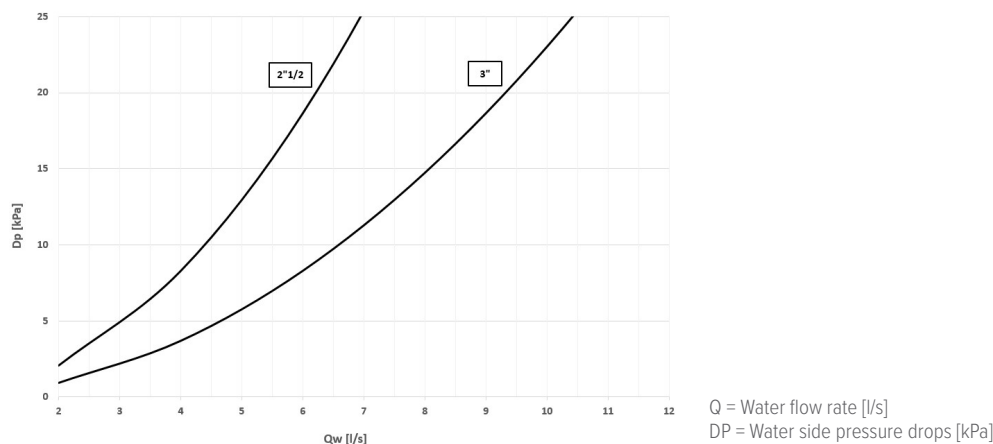

CCCA Copper/aluminium condenser coil with acrylic lining
 Coils with copper pipes and aluminium fins with acrylic coating. They can be used in environments containing airborne concentrations of salt and other moderately aggressive agents.
 The treatment entails:
 Cooling capacity variation -2.7%.
 Compressor power input variation +4.2%.
 Operating range reduction -2.1°C.

CCCA1 Condenser coil with Energy Guard DCC Aluminum
 This treatment provides excellent and guaranteed thermal exchange over time and protects finned coil exchangers from corrosion. They can be used in environments containing airborne concentrations of salt and other very aggressive chemicals while maintaining coil performance over time.

PGFC Finned coil protection grilles
 The grilles protect the external coil from accidental contact with objects or persons. Ideal for installation in places where persons can pass from, such as car parks, terraces, etc.

PGCCH Anti-hail protection grilles
 Grille made of electro-welded and painted drawn steel suitable for protecting the external coil from hail damage.
 Accessory supplied installed on the unit.

Built-in options

TCDC

Drain pan with electric heater

The drain pan made of steel AISI 316 allows the collection and discharge of the condensate

The two trays, located under the coils, are equipped with Mylar antifreeze electric heaters applied to the bottom and a drain located on the rear part, on the water connection side.

The electric heaters are thermostatically controlled and are activated according to the external air temperature ($T_a < +5^\circ\text{C}$).

RPR

Refrigerant leak detector

The leak detector device, in-built on the unit and positioned inside the compressor compartment, detects leaks from the internal refrigeration circuit.

REMAU

Additional board for advanced functions management

Multifunction board installed in the electrical panel of the unit for the advanced functions management.

The available digital contacts allow the following remote functions:

- remote on/off
- heat/cool (summer/winter switch)
- DHW production (heat pump version only)
- Double set-point management
- Sgready function
- EVUlock function
- Demand limit
- Activation of silent or super-silent acoustic version (selectable on the user interface)

The additional board does not allow the simultaneous use of digital inputs and Modbus signal.

ABU

Water connections flush with the unit are required

The water connections of the unit in standard configuration (without hydronic groups installed on board, or accumulation tank or DHW switching valve), end at the plate heat exchanger.

It is necessary to select this option if water connections flush with the unit are required

If hydronic groups or buffer tank or DHW switching valve are selected, the ABU option is automatically selected.

IFWX

Water side steel mesh filter

The device prevents any impurity in the hydraulic circuit from soiling the exchanger. The stainless steel mesh mechanical filter must be placed on the water inlet line. It needs to be easy to remove for periodical maintenance and cleaning operations. The Victaulic filter water connections are 2" 1/2 for sizes 45.4 to 60.4 and 3" for sizes 65.4 to 85.4.

Filter pressure drop

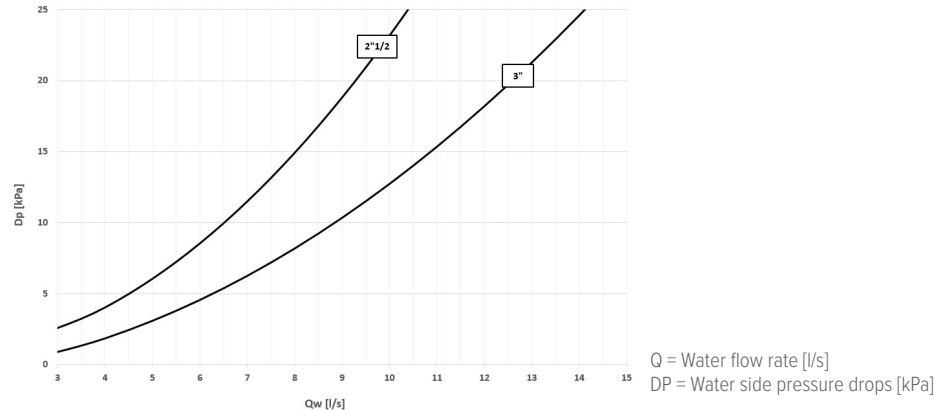

AVIBX

Anti-vibration mount support

The rubber antivibration mounts are attached in special housing on the support frame and serve to smooth the vibrations produced by the unit, thus reducing the noise transmitted to the support structure.

AMMSX

Anti-seismic spring antivibration mounts

The anti-seismic spring antivibration mounts must be fastened in special housings on the supporting metal struts. The containment structure is designed to ensure high resistance multidirectional forces acting on the surface of the unit in the presence of wind and / or telluric movements. The antivibration mounts have been tested according to ANSI/ASHRAE standard 171-2008 (Method of Testing Seismic Restraint devices for HVAC&R Equipment). The performance levels and test methodology have been validated and certified by Lloyd's Register.

⚠ Installation provided by the Customer.

PGFCX

Finned coil protection grilles

The grilles protect the external coil from accidental contact with objects or persons. Ideal for installation in places where persons can pass from, such as car parks, terraces, etc.

PGCCHX

Anti-hail protection grilles

Grille made of electro-welded and painted drawn steel suitable for protecting the external coil from hail damage.

IOTX

IoT industrial module for cloud based interoperability & services

This device allows the monitoring and the remote control the unit via Clivet Eye, the supervision cloud system for Clivet units.

With IoT module (i-LINK) it will be possible to monitor and manage the unit through the mobile app Clivet Eye and the dedicated web page.

Among the main functions, for all monitored units they allow to:

- display the main working parameters;
- display the alarms;
- switch on/off the unit;
- change the setpoint;
- change the operating mode;
- set the daily/weekly start-up or power-off programming of the unit;
- create charts of main system parameters trend (via web interface);
- display in a map the units monitored by Clivet Eye (via web interface).

Web interface at www.cliveteye.com.

Clivet Eye app available in Google Play and Apple Store

- ⚠ IoT module to be provided for each unit to be remotely monitored.
- ⚠ Internet ethernet connection in charge of customer.
- ⚠ Clivet Eye management is alternative to an external BMS supervision system.
- ⚠ Installation provided by the Customer.



General technical data

Performance

Acoustic configuration with compressor soundproofing (SC)

Size			45.4	50.4	55.4	60.4	65.4	70.4	75.4	80.4	85.4
Cooling											
Cooling capacity	1	[kW]	115	127	139	152	164	176	196	215	233
Compressor power input	1	[kW]	40,1	47,0	52,4	62,5	61,0	69,3	67,5	79,6	92,7
Total power input	2	[kW]	43,7	50,7	56,0	66,1	66,4	74,7	73,0	85,0	98,1
Partial recovery heating capacity	3	[kW]	37,3	41,8	46,0	51,5	54,0	58,9	63,3	70,8	78,2
EER	1	-	2,63	2,51	2,49	2,30	2,47	2,36	2,69	2,53	2,38
Water flow-rate (User Side)	1	[l/s]	5,5	6,0	6,6	7,2	7,8	8,4	9,3	10,2	11,1
Internal exchanger pressure drop	1	[kPa]	19,6	23,5	19,7	23,2	20,8	23,7	28,9	34,2	39,7
Cooling capacity (EN14511:2018)	4	[kW]	115	127	139	152	164	176	196	215	233
Total power input (EN14511:2018)	4	[kW]	44,0	51,0	56,3	66,5	66,8	75,2	73,6	85,8	99,0
EER (EN14511:2018)	4	-	2,62	2,49	2,47	2,29	2,46	2,34	2,66	2,51	2,35
SEER	6	-	4,51	4,51	4,38	4,37	4,48	4,45	4,48	4,45	4,42
SEPR	7	-	5,55	5,50	5,45	5,42	5,46	5,42	5,53	5,38	5,28
Cooling capacity (AHRI 550/590)	5	[kW]	115	127	139	152	164	176	196	215	233
Compressor power input (AHRI 550/590)	5	[kW]	43,7	50,7	56,0	66,1	66,4	74,7	73,0	85,0	98,1
COPR	5	-	2,63	2,51	2,49	2,30	2,47	2,36	2,69	2,53	2,38
IPLV	5	-	4,28	4,25	4,12	4,04	4,23	4,22	4,23	4,19	4,16
heating											
Heating capacity	8	[kW]	118	130	150	170	190	210	230	250	268
Compressor power input	8	[kW]	33,8	39,2	43,3	50,9	54,0	61,5	64,2	73,2	82,1
Total power input	2	[kW]	37,4	42,8	46,9	54,6	59,4	67,0	69,6	78,7	87,5
COP	8	-	3,15	3,03	3,19	3,11	3,19	3,13	3,30	3,17	3,06
Water flow-rate (User Side)	8	[l/s]	5,7	6,3	7,2	8,2	9,2	10,1	11,1	12,1	12,9
Internal exchanger pressure drop	8	[kPa]	21,1	25,2	23,3	29,2	28,0	33,7	39,8	46,4	52,8
Heating capacity (EN14511:2018)	9	[kW]	118	130	150	170	190	210	230	250	268
Total power input (EN14511:2018)	9	[kW]	37,7	43,2	47,3	55,1	60,0	67,7	70,5	79,7	88,7
COP (EN14511:2018)	9	-	3,13	3,01	3,17	3,09	3,17	3,10	3,26	3,14	3,02
SCOP - AVERAGE Climate - W35	6	-	4,16	4,12	4,15	4,07	4,19	4,15	4,22	4,16	4,11
SCOP - MEDIUM Climate - W55	6	-	2,97	2,88	2,96	2,88	2,93	2,87	2,99	2,95	2,93

The Product complies with the European ErP Directive (Energy Related Products), which includes the Commission Regulation (EU) 2016/2281, also known as Ecodesign LOT21. Contains fluorinated greenhouse gases (GWP 675)

1. Data referring to the following conditions: Water temperature to the internal exchanger = 12/7 °C. Temperature of air entering the external exchanger = 35°C. Evaporator fouling factor = $0.44 \times 10^{(-4)}$ m² K/W
2. The Total Power Input value does not take into account the part related to the pumps and required to overcome the pressure drops for the circulation of the solution inside the exchangers
3. Recovery exchanger water = 40/45°C
4. Data compliant to Standard EN 14511:2018 referred to the following conditions: internal exchanger water temperature = 12/7 °C. Entering external exchanger air temperature = 35°C
5. Data calculated in accordance with AHRI 550/590 under the following conditions: Water temperature to the internal exchanger = 6.7 °C. Water flow-rate 0.043 l/s per kW. Temperature of air entering the external exchanger = 35°C. Evaporator fouling factor = $0.18 \times 10^{(-4)}$ m² K/W
6. Data calculated in compliance with EN 14825:2018.
7. Data calculated according to the EU 2016/2281 Regulation
8. Data referring to the following conditions: Internal heat exchanger water temperature = 40/45 °C. Temperature of air entering the external exchanger = 7°C D.B./6°C W.B. Evaporator fouling factor = $0.44 \times 10^{(-4)}$ m² K/W
9. Data calculated in accordance with EN 14511:2013 under the following conditions: Internal heat exchanger water temperature = 40/45 °C. Temperature of air entering the external exchanger = 7°C D.B./6°C W.B.

Silenced acoustic configuration (LN)

Size			45.4	50.4	55.4	60.4	65.4	70.4	75.4	80.4	85.4
Cooling											
Cooling capacity	1	[kW]	110	122	134	146	157	169	186	204	224
Compressor power input	1	[kW]	39,5	46,2	51,3	61,1	60,0	68,0	65,7	77,1	90,7
Total power input	2	[kW]	42,5	49,2	54,3	64,1	64,5	72,5	70,2	81,6	95,2
Partial recovery heating capacity	3	[kW]	35,9	40,4	44,5	49,8	52,1	56,9	60,5	67,5	75,6
EER	1	-	2,59	2,48	2,47	2,28	2,44	2,34	2,66	2,50	2,36
Water flow-rate (User Side)	1	[l/s]	5,2	5,8	6,4	6,9	7,5	8,0	8,9	9,7	10,7
Internal exchanger pressure drop	1	[kPa]	18,0	21,8	18,4	21,6	19,2	22,0	26,2	31,1	36,9
Cooling capacity (EN14511:2018)	4	[kW]	110	122	134	146	157	169	186	204	224
Total power input (EN14511:2018)	4	[kW]	42,7	49,5	54,6	64,5	64,8	72,9	70,7	82,3	96,0
EER (EN14511:2018)	4	-	2,58	2,47	2,46	2,26	2,42	2,32	2,63	2,48	2,33
SEER	6	-	4,48	4,44	4,38	4,36	4,40	4,37	4,46	4,42	4,37
SEPR	7	-	5,54	5,49	5,46	5,43	5,45	5,40	5,53	5,39	5,29
Cooling capacity (AHRI 550/590)	5	[kW]	110	122	134	146	157	169	186	204	224
Compressor power input (AHRI 550/590)	5	[kW]	42,5	49,2	54,3	64,1	64,5	72,5	70,2	81,6	95,2
COPR	5	-	2,59	2,48	2,47	2,28	2,44	2,34	2,66	2,50	2,36
IPLV	5	-	4,25	4,21	4,12	4,11	4,16	4,11	4,20	4,19	4,12
heating											
Heating capacity	8	[kW]	118	130	150	170	190	210	230	250	268
Compressor power input	8	[kW]	33,8	39,2	43,3	50,9	54,0	61,5	64,2	73,2	82,1
Total power input	2	[kW]	37,4	42,8	46,9	54,6	59,4	67,0	69,6	78,7	87,5
COP	8	-	3,15	3,03	3,19	3,11	3,19	3,13	3,30	3,17	3,06
Water flow-rate (User Side)	8	[l/s]	5,7	6,3	7,2	8,2	9,2	10,1	11,1	12,1	12,9
Internal exchanger pressure drop	8	[kPa]	21,1	25,2	23,3	29,2	28,0	33,7	39,8	46,4	52,8
Heating capacity (EN14511:2018)	9	[kW]	118	130	150	170	190	210	230	250	268
Total power input (EN14511:2018)	9	[kW]	37,7	43,2	47,3	55,1	60,0	67,7	70,5	79,7	88,7
COP (EN14511:2018)	9	-	3,13	3,01	3,17	3,09	3,17	3,10	3,26	3,14	3,02
SCOP - AVERAGE Climate - W35	6	-	4,16	4,12	4,15	4,07	4,19	4,15	4,22	4,16	4,11
SCOP - MEDIUM Climate - W55	6	-	2,97	2,88	2,96	2,88	2,93	2,87	2,99	2,95	2,93

The Product complies with the European ErP Directive (Energy Related Products), which includes the Commission Regulation (EU) 2016/2281, also known as Ecodesign LOT21. Contains fluorinated greenhouse gases (GWP 675)

1. Data referring to the following conditions: Water temperature to the internal exchanger = 12/7 °C. Temperature of air entering the external exchanger = 35°C. Evaporator fouling factor = $0.44 \times 10^{(-4)}$ m² K/W
2. The Total Power Input value does not take into account the part related to the pumps and required to overcome the pressure drops for the circulation of the solution inside the exchangers
3. Recovery exchanger water = 40/45°C
4. Data compliant to Standard EN 14511:2018 referred to the following conditions: internal exchanger water temperature = 12/7 °C. Entering external exchanger air temperature = 35°C
5. Data calculated in accordance with AHRI 550/590 under the following conditions: Water temperature to the internal exchanger = 6.7 °C. Water flow-rate 0.043 l/s per kW. Temperature of air entering the external exchanger = 35°C. Evaporator fouling factor = $0.18 \times 10^{(-4)}$ m² K/W
6. Data calculated in compliance with EN 14825:2018.
7. Data calculated according to the EU 2016/2281 Regulation
8. Data referring to the following conditions: Internal heat exchanger water temperature = 40/45 °C. Temperature of air entering the external exchanger = 7°C D.B./6°C W.B. Evaporator fouling factor = $0.44 \times 10^{(-4)}$ m² K/W
9. Data calculated in accordance with EN 14511:2013 under the following conditions: Internal heat exchanger water temperature = 40/45 °C. Temperature of air entering the external exchanger = 7°C D.B./6°C W.B.

General technical data

Super-silenced acoustic configuration (EN)

Size			45.4	50.4	55.4	60.4	65.4	70.4	75.4	80.4	85.4
Cooling											
Cooling capacity	1	[kW]	103	114	125	136	146	157	173	189	208
Compressor power input	1	[kW]	39,4	46,4	51,5	60,7	59,9	67,9	65,6	76,4	90,1
Total power input	2	[kW]	41,6	48,6	53,7	62,9	63,2	71,2	68,9	79,7	93,4
Partial recovery heating capacity	3	[kW]	34,2	38,5	42,4	47,3	49,5	54,0	57,3	63,8	71,6
EER	1	-	2,48	2,35	2,33	2,16	2,31	2,21	2,52	2,37	2,23
Water flow-rate (User Side)	1	[l/s]	4,9	5,4	5,9	6,5	6,9	7,5	8,2	9,0	9,9
Internal exchanger pressure drop	1	[kPa]	16,0	19,3	16,3	18,9	16,8	19,2	22,9	27,0	32,2
Cooling capacity (EN14511:2018)	4	[kW]	103	114	125	136	146	157	173	189	208
Total power input (EN14511:2018)	4	[kW]	41,8	48,9	53,9	63,2	63,5	71,5	69,3	80,3	94,1
EER (EN14511:2018)	4	-	2,47	2,33	2,32	2,15	2,30	2,20	2,50	2,35	2,21
SEER	6	-	4,43	4,40	4,34	4,31	4,37	4,34	4,37	4,32	4,30
SEPR	7	-	5,49	5,44	5,42	5,38	5,40	5,39	5,51	5,35	5,25
Cooling capacity (AHRI 550/590)	5	[kW]	103	114	125	136	146	157	173	189	208
Compressor power input (AHRI 550/590)	5	[kW]	41,6	48,6	53,7	62,9	63,2	71,2	68,9	79,7	93,4
COPR	5	-	2,48	2,35	2,33	2,16	2,31	2,21	2,52	2,37	2,23
IPLV	5	-	4,18	4,16	4,12	4,06	4,11	4,09	4,12	4,10	4,08
heating											
Heating capacity	8	[kW]	118	130	150	170	190	210	230	250	268
Compressor power input	8	[kW]	33,8	39,2	43,3	50,9	54,0	61,5	64,2	73,2	82,1
Total power input	2	[kW]	37,4	42,8	46,9	54,6	59,4	67,0	69,6	78,7	87,5
COP	8	-	3,15	3,03	3,19	3,11	3,19	3,13	3,30	3,17	3,06
Water flow-rate (User Side)	8	[l/s]	5,7	6,3	7,2	8,2	9,2	10,1	11,1	12,1	12,9
Internal exchanger pressure drop	8	[kPa]	21,1	25,2	23,3	29,2	28,0	33,7	39,8	46,4	52,8
Heating capacity (EN14511:2018)	9	[kW]	118	130	150	170	190	210	230	250	268
Total power input (EN14511:2018)	9	[kW]	37,7	43,2	47,3	55,1	60,0	67,7	70,5	79,7	88,7
COP (EN14511:2018)	9	-	3,13	3,01	3,17	3,09	3,17	3,10	3,26	3,14	3,02
SCOP - AVERAGE Climate - W35	6	-	4,16	4,12	4,15	4,07	4,19	4,15	4,22	4,16	4,11
SCOP - MEDIUM Climate - W55	6	-	2,97	2,88	2,96	2,88	2,93	2,87	2,99	2,95	2,93

The Product complies with the European ErP Directive (Energy Related Products), which includes the Commission Regulation (EU) 2016/2281, also known as Ecodesign LOT21. Contains fluorinated greenhouse gases (GWP 675)

1. Data referring to the following conditions: Water temperature to the internal exchanger = 12/7 °C. Temperature of air entering the external exchanger = 35°C. Evaporator fouling factor = $0.44 \times 10^{(-4)}$ m² K/W
2. The Total Power Input value does not take into account the part related to the pumps and required to overcome the pressure drops for the circulation of the solution inside the exchangers
3. Recovery exchanger water = 40/45°C
4. Data compliant to Standard EN 14511:2018 referred to the following conditions: internal exchanger water temperature = 12/7 °C. Entering external exchanger air temperature = 35°C
5. Data calculated in accordance with AHRI 550/590 under the following conditions: Water temperature to the internal exchanger = 6.7 °C. Water flow-rate 0.043 l/s per kW. Temperature of air entering the external exchanger = 35°C. Evaporator fouling factor = $0.18 \times 10^{(-4)}$ m² K/W
6. Data calculated in compliance with EN 14825:2018.
7. Data calculated according to the EU 2016/2281 Regulation
8. Data referring to the following conditions: Internal heat exchanger water temperature = 40/45 °C. Temperature of air entering the external exchanger = 7°C D.B./6°C W.B. Evaporator fouling factor = $0.44 \times 10^{(-4)}$ m² K/W
9. Data calculated in accordance with EN 14511:2013 under the following conditions: Internal heat exchanger water temperature = 40/45 °C. Temperature of air entering the external exchanger = 7°C D.B./6°C W.B.

Construction - SC / LN / EN

Size		45.4	50.4	55.4	60.4	65.4	70.4	75.4	80.4	85.4	
Compressor											
Type of compressors		ROTARY INVERTER				ROTARY INVERTER / SCROLL INVERTER		SCROLL INVERTER			
Refrigerant								R-32			
No. of compressors	[Nr]	4	4	4	4	4	4	4	4	4	
Rated power (C1)	[HP]	25	25	25	25	35	35	45	45	45	
Rated power (C2)	[HP]	25	25	35	35	35	35	45	45	45	
Std Capacity control steps								STEPLESS			
Oil charge (C1)	[l]	4,6	4,6	4,6	4,6	6,2	6,2	7,2	7,2	7,2	
Oil charge (C2)	[l]	4,6	4,6	6,2	6,2	6,2	6,2	7,2	7,2	7,2	
Refrigerant charge (C1)	[Kg]	14,5	14,5	14,5	14,5	21,0	21,0	25,0	25,0	25,0	
Refrigerant charge (C2)	[Kg]	14,5	14,5	16,5	16,5	21,0	21,0	25,0	25,0	25,0	
Refrigeration circuits	[Nr]	2	2	2	2	2	2	2	2	2	
Internal exchanger											
Type of internal exchanger	1							PHE			
N. of internal exchanger	[Nr]	1	1	1	1	1	1	1	1	1	
Water content	[l]	10,5	10,5	13,2	13,2	15,4	15,4	15,4	15,4	15,4	
Minimum system water content	[l]	970	1050	1150	1250	1370	1450	1610	1780	1930	
External exchanger											
Type of internal exchanger	2							CCHY			
Number of coils	[Nr]	2	2	2	2	2	2	2	2	2	
External Section Fans											
Type of fans	3							AX			
No. of fans	[Nr]	2	2	2	2	3	3	3	3	3	
Type of motor								BRUSHLESS DC			
Standard airflow (SC)	[l/s]	16667	16667	16667	16667	25000	25000	25000	25000	25000	
Standard airflow (LN)	[l/s]	15556	15556	15556	15556	23333	23333	23333	23333	23333	
Standard airflow (EN)	[l/s]	14444	14444	14444	14444	21667	21667	21667	21667	21667	
Connections											
Water fittings		2"1/2	2"1/2	2"1/2	2"1/2	3"	3"	3"	3"	3"	
Power supply											
Standard power supply								400/3/50			
Electrical data											
F.L.A. - Total	[A]	123	129	126	133	132	139	173	182	192	
F.L.I. - Total	[kW]	70,6	74,3	72,5	76,4	75,9	79,9	99,3	105	110	
M.I.C. - Value	4 [A]	59,0	59,0	74,0	74,0	89,0	89,0	111	111	111	

1. PHE = Plate exchanger
2. CCHY = Copper / aluminium condenser coil with hydrophilic treatment
3. AX = Axial fan
4. M.I.C.=Maximum unit starting current. The M.I.C. value is obtained adding the max. compressor starting current of the highest size to the power input at max. admissible conditions (F.L.A.) of the remaining electric components.

Voltage unbalance between phases: max 2 %

Voltage variation: max +/- 10%

Electrical data refer to standard units; according to the installed accessories, the data can suffer some variations.

General technical data

Sound levels

Acoustic configuration with compressor soundproofing (SC)

Size	Sound power level								Sound pressure level dB(A)	Sound power level dB(A)
	Octave band (Hz)									
	63	125	250	500	1000	2000	4000	8000		
45.4	68	71	77	78	81	81	70	66	67	85
50.4	68	71	77	78	81	81	70	66	67	85
55.4	69	72	78	79	82	82	71	67	68	86
60.4	69	72	78	79	82	82	71	67	68	86
65.4	83	79	78	80	83	85	75	70	70	88
70.4	83	79	78	80	83	85	75	70	70	88
75.4	84	80	79	81	84	86	76	71	71	89
80.4	84	80	79	81	84	86	76	71	71	89
85.4	84	80	79	81	84	86	76	71	71	89

Silenced acoustic configuration (LN)

Size	Sound power level								Sound pressure level dB(A)	Sound power level dB(A)
	Octave band (Hz)									
	63	125	250	500	1000	2000	4000	8000		
45.4	61	66	72	74	78	76	67	65	63	81
50.4	61	66	72	74	78	76	67	65	63	81
55.4	62	67	73	75	79	77	68	66	64	82
60.4	62	67	73	75	79	77	68	66	64	82
65.4	77	76	73	76	80	80	71	67	66	84
70.4	77	76	73	76	80	80	71	67	66	84
75.4	78	77	74	77	81	81	72	68	67	85
80.4	78	77	74	77	81	81	72	68	67	85
85.4	78	77	74	77	81	81	72	68	67	85

Super-silenced acoustic configuration (EN)

Size	Sound power level								Sound pressure level dB(A)	Sound power level dB(A)
	Octave band (Hz)									
	63	125	250	500	1000	2000	4000	8000		
45.4	57	63	67	70	75	68	62	62	59	77
50.4	57	63	67	70	75	68	62	62	59	77
55.4	58	64	68	71	76	69	63	63	60	78
60.4	58	64	68	71	76	69	63	63	60	78
65.4	76	72	71	74	77	74	68	65	62	80
70.4	76	72	71	74	77	74	68	65	62	80
75.4	77	73	72	75	78	75	69	66	63	81
80.4	77	73	72	75	78	75	69	66	63	81
85.4	77	73	72	75	78	75	69	66	63	81

Sound levels refer to full load units, in test nominal conditions. The sound pressure level refers to 1 m. from the standard unit outer surface operating in open field. Measures according to UNI EN ISO 9614-2 regulations, with respect to the EUROVENT 8/1 certification, which provides for a tolerance of 3 dB(A).

Data referred to the following conditions:

- internal exchanger water temperature = 12/7 °C

- Temperature of air entering the external exchanger = 35°C.

Operating range - Cooling

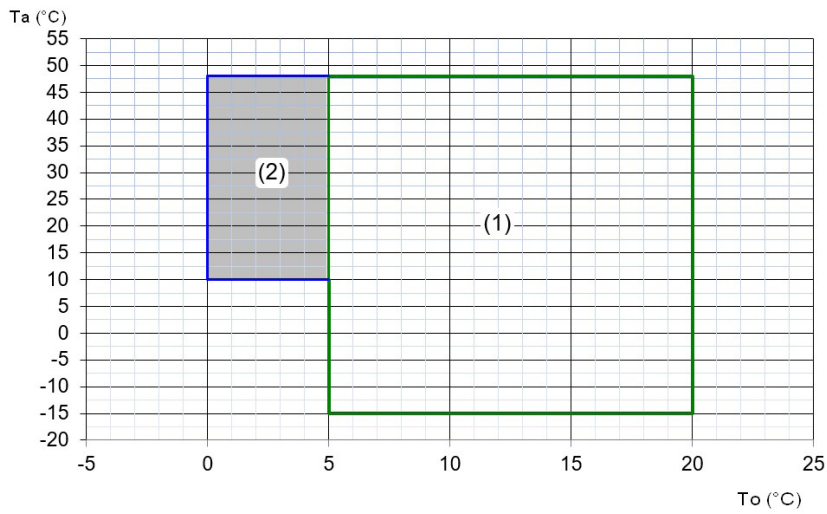

1. Standard unit operating range
2. Operating range where the use of glycol is mandatory in relation to the temperature of the outlet water from the user side exchanger

Operating range - Heating

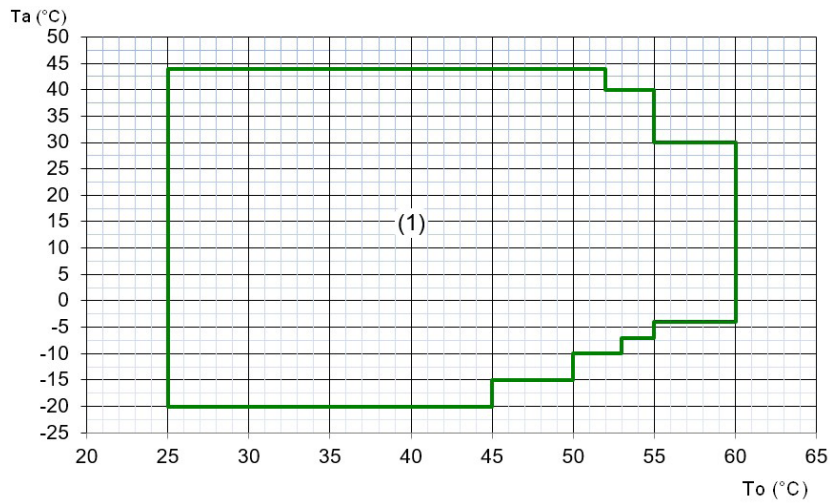

1. Standard unit operating range

General technical data

Correction factors for ethylene glycol use

% ETHYLENE GLYCOL BY WEIGHT		5%	10%	15%	20%	25%	30%	35%	40%	45%	50%
Freezing temperature	°C	-2	-3,9	-6,5	-8,9	-11,8	-15,6	-19,0	-23,4	-27,8	-32,7
Safety temperature	°C	3	1	-1	-4	-6	-10	-14	-19	-23,8	-29,4
Cooling Capacity Factor	No.	0,997	0,994	0,990	0,986	0,981	0,976	0,970	0,964	0,957	0,950
Compressor power input Factor	No.	0,999	0,999	0,998	0,997	0,996	0,996	0,995	0,994	0,993	0,993
Internal exchanger pressure drop factor	No.	1,016	1,035	1,056	1,080	1,106	1,135	1,166	1,200	1,236	1,275

Correction factors for propylene glycol use

% PROPYLENE GLYCOL BY WEIGHT		5%	10%	15%	20%	25%	30%	35%	40%	45%	50%
Freezing temperature	°C	-2	-3,9	-6,5	-8,9	-11,8	-15,6	-19,0	-23,4	-27,8	-32,7
Safety temperature	°C	3	1	-1	-4	-6	-10	-14	-19	-23,8	-29,4
Cooling Capacity Factor	No.	0,995	0,990	0,983	0,976	0,968	0,960	0,950	0,939	0,928	0,916
Compressor power input Factor	No.	0,999	0,997	0,995	0,993	0,991	0,988	0,986	0,983	0,980	0,977
Internal exchanger pressure drop factor	No.	1,027	1,058	1,093	1,133	1,176	1,224	1,276	1,332	1,393	1,457

Fouling Correction Factors

INTERNAL EXCHANGER (EVAPORATOR)

M2 °C/W	F1	FK1
0,44 x 10 (-4)	1,0	1,0
0,88 x 10 (-4)	0,97	0,99
1,76 x 10 (-4)	0,94	0,98

F1 = Cooling capacity correction factors

FK1 = Compressor power input correction factor

Exchanger operating range

INTERNAL EXCHANGER

		DPR	DPW
Plate exchanger	PED (CE)	4500	1000

DPr = Maximum operating pressure on refrigerant side in kPa

DPw = Maximum operating pressure on water side in kPa

Overload and control device calibrations

		OPEN	CLOSE	VALUE
Refrigerant side				
High pressure safety pressure switch	kPa	4200	3200	-
Low pressure safety pressure switch	kPa	140	300	-
Gas-liquid separator safety valve	kPa	-	-	3000
Safety thermostat against compressor drain overheating	°C	75	115	-
Water side				
Antifreeze protection	°C	8	4	-
High pressure safety valve	kPa	-	-	1000

Performance - Cooling

Acoustic configuration with compressor soundproofing (SC)

Size	To (°C)	Entering external exchanger air temperature (°C)											
		25		30		35		40		45		48	
		kWf	kWe_tot	kWf	kWe_tot	kWf	kWe_tot	kWf	kWe_tot	kWf	kWe_tot	kWf	kWe_tot
45.4	5	105	33,5	105	37,3	105	42,9	94,1	40,6	63,6	37,3	53,1	32,4
	6	109	33,8	110	37,6	110	43,3	98,0	41,0	66,1	37,7	55,1	32,7
	7	113	34,0	114	37,9	115	43,7	102	41,4	68,6	38,1	57,1	33,0
	10	120	34,4	120	38,4	119	44,3	107	41,9	72,7	38,6	60,8	33,5
	15	129	32,3	130	36,2	131	40,9	119	41,6	84,9	40,1	70,8	34,7
	18	132	29,8	133	33,4	135	36,9	125	38,9	92,4	40,8	76,9	35,3
	20	134	28,1	135	31,6	138	34,2	129	37,1	97,4	41,3	81,0	35,7
50.4	5	117	38,4	116	43,6	114	49,6	101	46,3	83,9	41,7	56,5	35,4
	6	121	38,8	121	44,1	121	50,1	105	46,8	87,3	42,1	58,7	35,7
	7	125	39,1	126	44,6	127	50,7	109	47,3	90,7	42,5	60,9	36,1
	10	133	39,8	132	45,3	130	51,5	115	47,9	96,0	43,1	64,7	36,7
	15	141	36,4	143	41,5	143	47,8	128	47,1	112	44,7	75,3	38,1
	18	143	32,4	146	37,1	148	43,3	135	44,8	122	45,5	81,8	38,9
	20	143	29,8	148	34,1	152	40,3	141	43,2	129	46,0	86,2	39,3
55.4	5	119	38,1	120	42,5	121	50,3	105	43,6	64,0	35,1	65,2	32,1
	6	124	38,4	125	42,9	130	53,1	109	43,9	66,3	35,3	67,3	32,3
	7	128	38,7	129	43,2	139	56,0	113	44,2	68,6	35,5	69,5	32,5
	10	135	39,1	136	43,7	142	50,7	119	44,7	72,9	35,9	74,3	32,9
	15	147	37,0	151	41,4	153	48,0	129	43,0	84,9	36,9	86,5	33,7
	18	152	34,4	158	38,5	161	44,7	137	40,5	92,7	37,3	94,4	34,1
	20	156	32,7	163	36,5	167	42,5	142	38,8	98,1	37,5	100	34,3
60.4	5	133	44,6	132	51,0	132	63,9	118	53,7	86,5	40,4	72,1	36,5
	6	138	45,1	137	51,4	142	65,0	122	54,1	89,6	40,7	74,6	36,7
	7	142	45,5	143	51,9	152	66,1	127	54,5	92,7	40,9	77,0	37,0
	10	150	46,2	149	52,7	154	66,0	134	55,2	98,5	41,4	82,2	37,5
	15	163	43,4	164	49,5	166	58,9	146	53,8	115	42,5	95,7	38,7
	18	169	39,9	170	45,5	174	50,8	156	51,2	125	43,1	104	39,2
	20	172	37,7	174	42,9	180	45,4	163	49,5	133	43,3	111	39,5
65.4	5	164	56,1	157	61,1	150	66,7	131	60,2	112	53,6	88,4	46,2
	6	169	56,4	163	61,5	157	66,6	136	60,5	116	53,9	91,4	46,5
	7	175	56,8	168	61,9	164	66,4	140	60,8	120	54,1	94,4	46,7
	10	184	57,4	177	62,5	169	68,1	148	61,2	127	54,6	101	47,1
	15	196	50,9	189	55,4	183	60,0	164	57,6	148	55,5	117	48,1
	18	198	43,8	191	47,5	186	51,3	173	53,5	162	55,8	129	48,4
	20	199	39,0	192	42,3	189	45,4	179	50,7	172	55,9	137	48,5
70.4	5	172	61,3	165	67,0	158	73,2	136	63,4	116	58,5	95,5	50,2
	6	179	61,8	171	67,5	167	74,0	141	63,7	121	58,7	98,9	50,4
	7	185	62,2	177	68,0	176	74,7	146	64,0	125	59,0	102	50,6
	10	194	63,0	186	68,7	178	74,9	153	64,5	132	59,4	109	51,0
	15	211	57,8	203	62,9	195	67,6	170	62,5	154	60,3	127	51,9
	18	217	52,0	210	56,3	202	59,6	182	59,7	168	60,6	139	52,2
	20	221	48,1	214	51,9	207	54,3	191	57,7	178	60,7	148	52,2
75.4	5	207	65,8	192	70,7	176	65,6	163	69,6	115	51,7	89,6	43,6
	6	213	66,2	199	71,2	186	69,3	169	70,0	119	52,1	92,5	43,8
	7	219	66,7	206	71,7	196	73,0	175	70,5	122	52,4	95,4	44,1
	10	233	67,6	218	72,6	199	67,4	184	71,2	128	53,0	100	44,6
	15	237	58,1	224	62,9	215	63,5	197	65,7	147	54,9	115	46,3
	18	238	48,2	222	52,5	221	59,1	200	61,4	158	56,2	123	47,5
	20	239	41,5	221	45,6	226	56,1	213	60,6	166	57,2	129	48,3
80.4	5	211	72,7	203	78,2	195	79,1	170	74,6	146	66,0	115	57,3
	6	218	73,2	210	78,8	205	82,1	176	75,1	151	66,5	119	57,7
	7	226	73,8	217	79,4	215	85,0	182	75,5	156	66,9	123	58,1
	10	241	75,0	231	80,6	221	81,5	192	76,3	163	67,5	129	58,7
	15	250	66,5	241	71,8	235	74,9	208	72,9	187	69,7	147	61,0
	18	252	57,4	243	62,3	240	67,5	218	68,9	203	71,3	159	62,5
	20	253	51,4	244	55,9	244	62,5	224	66,4	213	72,4	167	63,7
85.4	5	224	80,0	215	86,0	212	95,3	180	81,6	153	73,0	124	61,7
	6	231	80,7	222	86,8	223	96,7	186	82,1	159	73,4	129	62,1
	7	238	81,3	229	87,5	233	98,1	193	82,7	164	73,9	133	62,5
	10	255	82,8	244	89,0	241	98,4	203	83,7	172	74,6	139	63,1
	15	270	75,9	260	81,8	255	87,4	219	80,0	197	76,9	160	65,3
	18	276	68,3	267	73,7	259	75,3	232	77,5	214	78,5	173	66,8
	20	281	63,2	271	68,3	263	67,3	241	75,9	225	79,7	181	68,0

kWf = Cooling capacity in kW
 kWe_tot = Total power input in kW
 To (°C) = Internal exchanger outlet water temperature
 Performances in function of the inlet/outlet water temperature differential = 5°C

General technical data

Performance - Cooling

Silenced acoustic configuration (LN)

Size	To (°C)	Entering external exchanger air temperature (°C)											
		25		30		35		40		45		48	
		kWf	kWe_tot	kWf	kWe_tot	kWf	kWe_tot	kWf	kWe_tot	kWf	kWe_tot	kWf	kWe_tot
45.4	5	103	32,9	104	36,7	102	42,3	88,2	40,6	55,1	37,3	52,4	32,4
	6	107	33,2	108	37,1	106	42,4	91,8	41,0	57,1	37,7	54,5	32,7
	7	111	33,5	113	37,4	110	42,5	95,4	41,4	59,2	38,1	56,3	33,0
	10	117	34,0	118	38,0	117	43,8	101	41,9	62,9	38,6	60,0	33,5
	15	128	31,3	128	35,0	127	40,1	112	41,6	73,0	40,1	69,3	34,7
	18	130	28,1	131	31,5	130	35,7	119	38,9	79,2	40,8	75,0	35,3
	20	134	26,0	133	29,1	132	32,8	123	37,1	83,3	41,3	78,7	35,7
50.4	5	116	35,6	109	40,4	108	46,9	90,8	42,3	75,9	38,7	53,5	33,0
	6	120	35,9	114	40,9	115	48,0	94,5	42,8	78,9	39,0	55,5	33,3
	7	125	36,3	119	41,3	122	49,2	98,3	43,2	81,9	39,4	57,5	33,6
	10	132	36,9	125	42,0	123	48,8	104	43,8	86,8	40,0	61,2	34,2
	15	138	34,8	138	39,8	137	45,8	115	43,0	101	41,5	71,1	35,5
	18	141	32,2	144	36,9	143	41,9	123	42,0	110	42,3	77,2	36,2
	20	143	30,5	147	34,9	148	39,4	128	41,4	116	42,8	81,2	36,6
55.4	5	115	35,8	116	40,0	119	47,3	101	41,4	61,3	34,4	62,5	31,4
	6	119	36,0	121	40,3	126	50,8	105	41,7	63,4	34,7	64,6	31,6
	7	124	36,3	126	40,6	134	54,3	109	42,0	65,5	34,9	66,6	31,8
	10	130	36,7	131	41,1	137	48,6	115	42,5	69,7	35,4	71,2	32,3
	15	142	34,9	144	39,1	149	46,3	124	41,5	81,0	36,6	82,8	33,2
	18	147	32,6	150	36,5	156	43,4	132	39,3	88,3	37,1	90,4	33,7
	20	150	31,1	154	34,8	161	41,4	137	37,8	93,4	37,4	95,6	33,9
60.4	5	127	41,5	130	47,4	131	60,3	112	49,6	82,4	38,4	68,7	34,8
	6	132	41,9	134	47,8	138	62,2	117	50,0	85,3	38,7	71,0	35,0
	7	137	42,3	139	48,3	146	64,1	121	50,4	88,2	39,0	73,3	35,3
	10	144	42,9	146	48,9	148	62,3	127	50,9	93,8	39,5	78	35,8
	15	156	40,1	160	45,8	163	56,5	138	49,5	109	40,7	91,1	36,9
	18	161	36,7	165	41,8	169	49,9	147	47,1	119	41,3	99,4	37,4
	20	164	37,2	168	42,4	174	46,3	154	45,5	126	41,6	105	37,7
65.4	5	156	51,2	150	55,9	143	61,0	125	55,6	112	53,6	85,5	44,2
	6	162	51,6	155	56,2	150	62,7	129	55,8	116	53,9	88,5	44,4
	7	167	51,9	160	56,6	157	64,5	134	56,1	120	54,1	91,4	44,6
	10	175	52,4	168	57,1	161	62,2	141	56,5	127	54,6	97,3	45,0
	15	190	48,5	184	52,7	176	56,6	159	54,4	148	55,5	114	45,8
	18	195	44,0	191	47,7	180	50,3	171	52,7	162	55,8	125	46,1
	20	199	40,9	192	44,3	183	46,1	178	51,5	172	55,9	133	46,2
70.4	5	167	57,2	160	62,5	153	68,4	135	63,2	111	54,4	91,3	48,1
	6	172	57,6	165	62,9	161	70,4	140	63,5	115	54,6	94,4	48,3
	7	178	58,0	171	63,4	169	72,5	145	63,9	119	54,9	97,6	48,6
	10	187	58,7	180	64,0	172	69,9	152	64,3	126	55,3	104	49,0
	15	206	55,6	199	60,4	188	64,0	170	62,7	147	56,3	121	50,0
	18	215	51,7	208	56,1	194	57,3	181	59,8	160	56,6	133	50,4
	20	221	49,2	214	53,3	199	52,8	189	57,9	170	56,7	141	50,5
75.4	5	191	60,6	184	65,3	173	70,4	154	63,8	111	49,3	86,0	41,3
	6	197	61,0	190	65,7	181	70,3	159	64,2	115	49,6	88,7	41,6
	7	204	61,4	197	66,1	186	70,2	165	64,7	118	49,9	91,5	41,8
	10	216	62,1	208	66,9	192	64,3	173	65,3	124	50,4	96,3	42,3
	15	234	58,0	217	62,9	206	60,9	195	66,4	142	52,2	110	43,8
	18	237	53,5	219	58,2	211	56,8	200	64,3	153	53,4	118	44,8
	20	238	50,4	220	55,1	215	54,0	212	63,0	161	54,3	124	45,6
80.4	5	201	66,2	193	71,3	186	76,8	162	68,8	140	62,2	111	54,8
	6	208	66,7	200	71,8	195	79,2	168	69,2	145	62,6	115	55,1
	7	215	67,1	207	72,3	204	81,6	174	69,6	150	63,0	119	55,5
	10	228	68,1	219	73,3	210	79,0	182	70,3	157	63,5	125	56,1
	15	237	60,4	229	65,3	224	72,7	192	67,6	168	65,5	143	58,1
	18	241	52,0	233	56,6	229	65,5	197	61,6	176	62,5	154	59,6
	20	241	46,5	233	50,8	233	60,8	201	57,7	181	60,6	161	60,6
85.4	5	217	75,7	209	81,5	204	89,7	174	76,9	148	69,0	123	60,4
	6	224	76,3	216	82,2	214	92,4	180	77,4	153	69,4	127	60,8
	7	231	76,9	223	82,9	224	95,2	186	78,0	158	69,8	131	61,2
	10	247	78,3	237	84,3	231	92,6	196	78,8	166	70,4	137	61,8
	15	258	70,5	249	76,0	244	83,4	212	75,9	190	72,5	157	63,9
	18	262	61,9	253	67,0	248	73,1	223	72,5	206	74,0	170	65,3
	20	264	56,2	255	61,0	251	66,3	230	70,2	217	75,0	179	66,4

kWf = Cooling capacity in kW

kWe_tot = Total power input in kW

To (°C) = Internal exchanger outlet water temperature

Performances in function of the inlet/outlet water temperature differential = 5°C

Performance - Cooling

Super-silenced acoustic configuration (EN)

Size	To (°C)	Entering external exchanger air temperature (°C)											
		25		30		35		40		45		48	
		kWf	kWe_tot	kWf	kWe_tot	kWf	kWe_tot	kWf	kWe_tot	kWf	kWe_tot	kWf	kWe_tot
45.4	5	100	32,7	94,9	36,5	94,7	42,0	76,2	33,8	54,0	27,8	50,9	24,0
	6	104	33,0	99,2	36,9	98,9	41,8	79,3	34,1	55,9	28,1	52,6	24,2
	7	108	33,4	104	37,3	103	41,6	82,3	34,4	57,9	28,3	54,3	24,4
	10	114	33,9	108	37,9	108	43,8	87,0	34,9	61,6	28,8	57,9	24,8
	15	125	30,9	120	34,6	118	39,9	101	36,2	71,5	29,8	66,9	25,6
	18	130	27,3	124	30,7	121	35,2	109	33,1	77,5	30,4	72,3	26,0
20	133	24,9	126	28,0	123	32,1	116	37,4	81,5	30,7	75,9	26,2	
50.4	5	114	33,6	109	36,6	106	45,6	82,9	40,7	69,8	37,3	52,2	32,1
	6	119	34,0	114	37,0	110	47,1	86,3	41,2	72,6	37,7	54,1	32,4
	7	124	34,3	118	37,5	114	48,6	89,6	41,6	75,3	38,0	56,0	32,7
	10	132	34,9	124	38,1	120	47,5	94,5	42,2	79,9	38,6	59,6	33,3
	15	134	32,9	133	36,0	130	44,0	107	41,0	93,2	40,0	69,2	34,6
	18	135	30,3	134	33,1	133	39,5	112	40,2	101	40,7	75,0	35,3
20	132	28,5	135	31,3	135	36,5	116	39,6	107	41,2	78,8	35,7	
55.4	5	107	32,1	108	35,9	109	49,4	101	41,4	57,5	32,6	56,6	27,9
	6	111	32,4	112	36,2	117	51,5	105	41,7	59,4	32,9	58,3	28,1
	7	115	32,6	116	36,5	125	53,7	109	42,0	61,3	33,2	60,1	28,2
	10	121	32,9	122	36,9	128	50,7	115	42,5	65,4	33,7	64,4	28,6
	15	132	31,3	136	35,1	138	47,0	120	39,8	75,9	34,9	74,8	29,4
	18	137	29,3	142	32,9	145	42,6	127	37,5	82,6	35,4	81,6	29,7
20	139	28,0	146	31,5	150	39,7	131	35,9	87,3	35,7	86,3	29,9	
60.4	5	118	36,6	118	41,7	118	49,5	105	44,9	77,0	35,0	63,4	31,9
	6	123	36,9	124	42,1	127	56,2	109	45,3	79,6	35,2	65,5	32,1
	7	127	37,2	129	42,5	136	62,9	113	45,6	82,3	35,5	67,5	32,3
	10	133	37,7	133	43,0	137	58,6	119	46,1	87,6	35,9	72,2	32,8
	15	146	35,6	147	40,6	151	53,1	129	44,5	102	36,8	84,0	33,8
	18	151	33,0	153	37,7	157	46,7	138	42,7	111	37,3	91,6	34,3
20	154	40,3	167	46,0	172	51,3	152	48,3	118	37,5	96,9	34,5	
65.4	5	151	48,3	145	52,7	139	57,6	122	53,1	103	48,0	85,5	44,2
	6	156	48,6	150	53,0	142	60,4	126	53,4	107	48,2	88,5	44,4
	7	162	48,9	155	53,3	146	63,2	130	53,6	111	48,4	91,4	44,6
	10	170	49,4	163	53,8	156	58,8	137	54,0	117	48,8	97,3	45,0
	15	186	47,2	181	51,3	167	54,1	158	54,5	137	49,7	114	45,8
	18	194	44,5	191	48,2	169	48,8	168	52,3	150	50,0	125	46,1
20	199	42,7	192	46,1	171	45,3	176	50,8	159	50,1	133	46,2	
70.4	5	160	53,3	154	58,3	147	63,8	134	63,0	111	54,4	91,3	48,1
	6	166	53,7	159	58,7	152	67,5	138	63,4	115	54,6	94,4	48,3
	7	172	54,1	165	59,1	157	71,2	143	63,7	119	54,9	98	48,6
	10	180	54,7	173	59,7	165	65,2	151	64,2	126	55,3	104	49,0
	15	202	53,4	194	58,2	178	59,9	168	64,1	147	56,3	121	50,2
	18	213	51,6	206	56,0	182	53,9	180	62,2	160	56,6	133	50,5
20	221	50,3	214	54,6	184	49,9	188	60,9	170	56,7	141	50,6	
75.4	5	190	60,1	183	64,8	157	60,3	152	62,5	109	48,1	86,0	41,3
	6	197	60,5	189	65,3	165	64,6	157	62,9	113	48,4	88,7	41,6
	7	203	60,9	196	65,7	173	68,9	163	63,4	116	48,7	91,5	41,8
	10	215	61,7	207	66,5	178	61,9	171	64,0	122	49,2	96,3	42,3
	15	230	57,2	215	62,0	192	59,2	189	62,9	139	50,8	110	43,8
	18	236	52,2	217	56,9	197	56,0	199	61,4	150	52,0	118	44,8
20	237	48,9	219	53,5	201	53,8	207	60,5	158	52,9	124	45,6	
80.4	5	200	65,7	192	70,9	174	73,5	161	68,3	140	62,2	111	54,8
	6	207	66,2	199	71,4	182	76,6	167	68,8	145	62,6	115	55,1
	7	214	66,7	206	72,0	189	79,7	173	69,2	150	63,0	119	55,5
	10	227	67,7	218	73,0	197	75,6	181	69,9	157	63,5	125	56,1
	15	237	60,4	229	65,3	209	69,2	189	66,3	163	63,0	143	58,1
	18	239	52,3	231	56,9	213	62,0	195	61,1	172	61,2	154	59,6
20	240	47,0	232	51,3	216	57,1	199	57,6	178	60,0	161	60,6	
85.4	5	211	71,7	202	77,3	189	87,5	169	73,8	144	66,9	117	58,3
	6	218	72,3	209	77,9	199	90,4	175	74,3	149	67,4	121	58,7
	7	225	72,9	216	78,6	208	93,4	182	74,9	154	67,8	125	59,1
	10	239	74,1	230	79,8	214	90,3	191	75,7	162	68,4	131	59,7
	15	248	65,8	239	71,2	227	79,9	205	73,0	185	70,7	150	62,0
	18	248	56,8	240	61,6	231	68,4	215	69,1	201	72,3	161	63,6
20	248	50,7	240	55,3	234	60,8	221	66,6	211	73,4	169	64,8	

kWf = Cooling capacity in kW
 kWe_tot = Total power input in kW
 To (°C) = Internal exchanger outlet water temperature
 Performances in function of the inlet/outlet water temperature differential = 5°C

General technical data

Plate exchangers pressure drop (EVPHE)

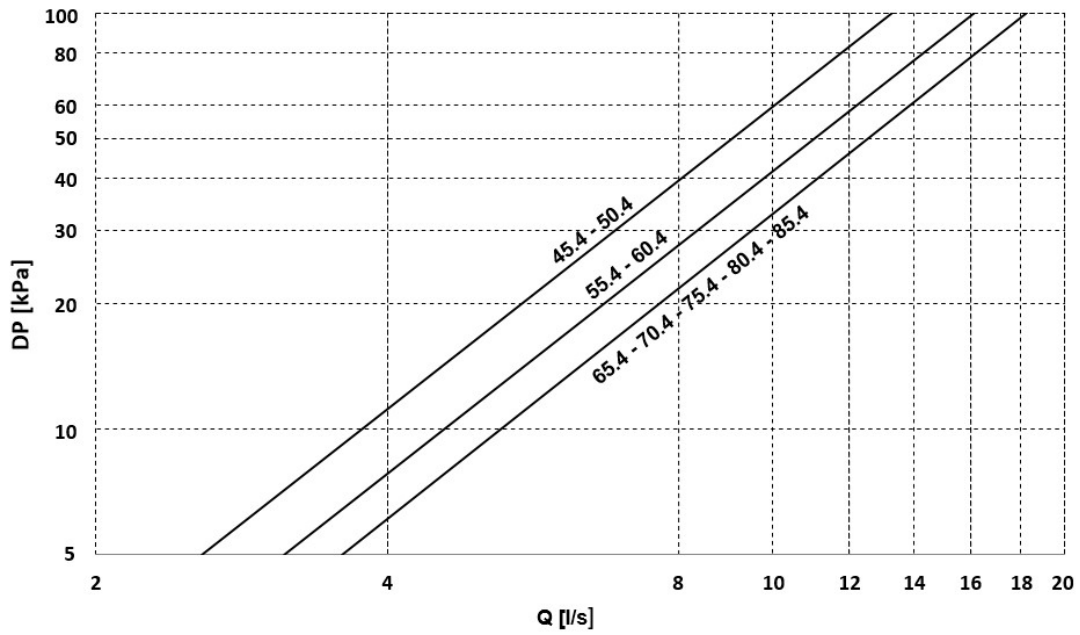

The pressure drops are calculated considering a water temperature of 7°C

Q = Water flow rate [l/s]

DP = Water side pressure drops [kPa]

The water flow rate must be calculated with the following formula

$$Q \text{ [l/s]} = \frac{kWf}{4,186 \times DT}$$

kWf = Cooling capacity in kW

DT = Temperature difference between inlet / outlet water

Admissible water flow rates

Minimum (Qmin) and maximum (Qmax) admissible water flow rates for correct operation of the unit.

SIZE		45.4	50.4	55.4	60.4	65.4	70.4	75.4	80.4	85.4
Qmin	[l/s]	2,6	2,6	3,1	3,1	3,6	3,6	3,6	3,6	3,6
Qmax	[l/s]	13,3	13,3	16,2	16,2	18,3	18,3	18,3	18,3	18,3

Performances - Cooling at part load

Acoustic configuration with compressor soundproofing (SC)

Size	Load	Entering external exchanger air temperature (°C)											
		35°C			30°C			25°C			20°C		
		kWf	kWe_tot	EER	kWf	kWe_tot	EER	kWf	kWe_tot	EER	kWf	kWe_tot	EER
45.4	100	115	43,7	2,63	114	37,9	3,02	113	34,0	3,32	119	31,1	3,82
	75	87,9	28,5	3,08	87,6	25,8	3,40	86,4	23,1	3,74	90,7	21,1	4,30
	50	57,5	15,9	3,62	57,5	14,2	4,05	57,0	12,6	4,54	60,1	11,4	5,28
	Minimum	22,9	6,42	3,57	23,0	5,73	4,01	23,0	5,08	4,53	22,6	4,35	5,19
50.4	100	127	50,7	2,51	126	44,6	2,82	125	39,1	3,21	126	33,3	3,77
	75	96,2	33,3	2,89	93,6	28,6	3,27	93,3	25,2	3,71	93,2	21,5	4,34
	50	64,7	19,1	3,38	63,1	16,3	3,88	63,1	14,2	4,45	63,2	12,0	5,28
	Minimum	21,7	6,90	3,15	23,1	6,61	3,49	24,7	5,79	4,26	24,8	4,94	5,02
55.4	100	139	56,0	2,49	129	43,2	2,99	128	38,7	3,31	134	35,4	3,78
	75	98,9	30,9	3,20	96,9	27,7	3,49	96,1	24,8	3,88	101	22,7	4,43
	50	65,6	18,5	3,55	64,7	16,2	3,98	64,7	14,3	4,54	68,2	12,9	5,28
	Minimum	26,1	7,78	3,35	26,0	6,87	3,78	26,2	6,08	4,31	25,8	5,27	4,89
60.4	100	152	66,1	2,30	143	51,9	2,75	142	45,5	3,13	142	38,8	3,66
	75	111	37,6	2,96	107	32,1	3,34	106	28,1	3,78	106	24,1	4,39
	50	74,2	22,5	3,30	72,1	18,8	3,84	71,9	16,2	4,43	71,9	13,7	5,25
	Minimum	25,6	8,15	3,13	28,5	7,69	3,71	28,9	6,68	4,33	29,1	5,72	5,09
65.4	100	164	66,4	2,47	168	61,9	2,72	175	56,8	3,08	182	52,2	3,49
	75	120	40,3	2,98	126	36,6	3,43	131	33,5	3,91	136	30,7	4,43
	50	72,5	22,2	3,26	76,4	19,8	3,86	80,3	17,8	4,51	84,2	16,2	5,20
	Minimum	27,0	8,95	3,02	28,7	8,04	3,57	30,3	7,33	4,14	32,0	6,80	4,71
70.4	100	176	74,7	2,36	177	68,0	2,61	185	62,2	2,97	192	57,0	3,37
	75	127	44,2	2,87	132	40,4	3,28	138	37,0	3,73	143	34,2	4,20
	50	77,8	24,4	3,19	81,9	21,8	3,76	85,9	19,6	4,39	90,0	17,8	5,05
	Minimum	27,0	8,08	3,34	28,6	7,26	3,95	30,3	6,62	4,58	31,9	6,14	5,20
75.4	100	196	73,0	2,69	206	71,7	2,87	219	66,7	3,28	221	62,1	3,55
	75	146	48,8	3,00	156	44,6	3,49	162	41,0	3,95	167	37,8	4,44
	50	90,7	27,7	3,28	94,9	24,6	3,86	99,0	21,9	4,51	103	19,7	5,22
	Minimum	32,8	10,2	3,20	34,4	9,07	3,79	36,0	8,09	4,46	37,6	7,30	5,16
80.4	100	215	85,0	2,53	217	79,4	2,74	226	73,8	3,06	233	68,7	3,40
	75	152	51,1	2,98	161	46,8	3,43	167	43,0	3,88	172	39,6	4,35
	50	92,9	28,7	3,24	97,2	25,5	3,81	101	22,8	4,44	105	20,5	5,14
	Minimum	33,8	10,6	3,18	35,5	9,44	3,76	37,2	8,43	4,41	38,8	7,62	5,09
85.4	100	233	98,1	2,38	229	87,5	2,62	238	81,3	2,93	247	75,6	3,26
	75	163	55,2	2,95	171	51,8	3,30	177	47,8	3,71	183	44,3	4,14
	50	105	32,7	3,23	106	29,2	3,63	111	26,3	4,22	115	23,7	4,86
	Minimum	35,9	10,0	3,58	37,7	8,89	4,23	39,4	7,94	4,96	41,0	7,15	5,74

Load = Percentage of cooling capacity compared to full load value

kWf = Cooling capacity in kW

kWe_tot = Total power input in kW

Internal heat exchanger water temperature = outlet 7°C / inlet 12°C / variable flow-rate with external exchanger air T.

General technical data

Performances - Cooling at part load

Silenced acoustic configuration (LN)

Size	Load	Entering external exchanger air temperature (°C)											
		35°C			30°C			25°C			20°C		
		kWf	kWe_tot	EER	kWf	kWe_tot	EER	kWf	kWe_tot	EER	kWf	kWe_tot	EER
45.4	100	110	42,5	2,59	113	37,4	3,02	111	33,5	3,48	117	30,6	3,83
	75	87,2	28,3	3,08	87,3	25,5	3,49	86,0	22,8	3,90	89,5	20,8	4,30
	50	57,5	15,9	3,62	57,1	14,2	4,02	57,0	12,6	4,54	60,1	11,4	5,28
	Minimum	22,9	6,42	3,80	22,8	6,13	3,96	22,9	5,57	4,38	22,5	4,79	4,99
50.4	100	122	49,2	2,48	119	41,3	2,88	125	36,3	3,27	126	33,1	3,78
	75	88,9	30,9	2,88	88,1	26,5	3,32	88,4	23,3	3,79	90,7	20,6	4,40
	50	60,4	17,4	3,46	59,3	14,8	4,01	59,0	12,9	4,58	59,2	10,9	5,44
	Minimum	21,1	6,68	3,15	22,4	6,40	3,50	24,0	5,60	4,28	24,1	4,78	5,05
55.4	100	134	54,3	2,47	126	40,6	3,10	124	36,3	3,40	129	33,2	3,88
	75	95,0	30,5	3,11	93,2	26,6	3,50	93,0	23,7	3,90	97,3	21,7	4,47
	50	65,6	18,5	3,55	64,8	16,2	3,99	64,7	14,3	4,54	68,2	12,9	5,28
	Minimum	25,8	7,52	3,23	25,6	6,73	3,59	25,7	6,03	4,03	25,2	5,26	4,52
60.4	100	146	64,1	2,28	139	48,3	2,88	137	42,3	3,23	136	36,0	3,78
	75	105	35,4	2,96	101,5	30,2	3,36	102	26,4	3,85	101	22,6	4,48
	50	70,7	21,0	3,36	69,2	17,6	3,94	68,7	15,1	4,53	68,8	12,8	5,37
	Minimum	24,8	7,87	3,15	27,6	7,50	3,68	28,0	6,57	4,26	28,1	5,65	4,97
65.4	100	157	64,5	2,44	160	56,6	2,84	167	51,9	3,22	174	47,7	3,64
	75	118	39,4	3,00	124	35,9	3,45	129	32,8	3,94	134	30,1	4,46
	50	68,9	20,8	3,31	72,8	18,5	3,94	76,6	16,6	4,61	80,3	15,1	5,30
	Minimum	27,0	8,95	3,02	28,7	8,04	3,57	30,3	7,33	4,14	32,0	6,80	4,71
70.4	100	169	72,5	2,34	171	63,4	2,70	178	58,0	3,07	185	53,2	3,49
	75	121	41,3	2,93	127	37,6	3,37	132	34,3	3,85	137	31,5	4,35
	50	77,8	24,4	3,19	81,9	21,8	3,76	85,9	19,6	4,39	90,0	17,8	5,05
	Minimum	27,0	8,08	3,34	28,6	7,26	3,95	30,3	6,62	4,58	31,9	6,14	5,20
75.4	100	186	70,2	2,66	197	66,1	2,97	204	61,4	3,32	211	57,1	3,69
	75	142	45,7	3,11	149	41,7	3,57	155	38,2	4,06	160	35,1	4,57
	50	86,2	25,7	3,35	90,2	22,8	3,96	94,2	20,3	4,65	98,0	18,2	5,40
	Minimum	30,6	9,46	3,23	32,2	8,34	3,86	33,7	7,41	4,55	35,3	6,67	5,29
80.4	100	204	81,6	2,50	207	72,3	2,86	215	67,1	3,20	222	62,4	3,56
	75	147	48,4	3,04	155	44,1	3,51	161	40,5	3,97	166	37,3	4,46
	50	88,5	26,7	3,31	92,6	23,7	3,91	96,6	21,1	4,58	101	18,9	5,31
	Minimum	32,8	10,2	3,20	34,4	9,07	3,79	36,0	8,09	4,46	37,6	7,30	5,16
85.4	100	224	95,2	2,36	223	82,9	2,69	231	76,9	3,01	240	71,5	3,35
	75	160	53,9	2,97	166	49,6	3,35	172	45,7	3,77	178	42,4	4,21
	50	100	31,6	3,15	104	28,2	3,68	108	25,3	4,28	113	22,8	4,94
	Minimum	34,8	10,0	3,49	36,6	8,9	4,12	38,2	7,93	4,82	39,9	7,17	5,56

Load = Percentage of cooling capacity compared to full load value

kWf = Cooling capacity in kW

kWe_tot = Total power input in kW

Internal heat exchanger water temperature = outlet 7°C / inlet 12°C / variable flow-rate with external exchanger air T.

Performances - Cooling at part load

Super-silenced acoustic configuration (EN)

Size	Load	Entering external exchanger air temperature (°C)											
		35°C			30°C			25°C			20°C		
		kWf	kWe_tot	EER	kWf	kWe_tot	EER	kWf	kWe_tot	EER	kWf	kWe_tot	EER
45.4	100	103	41,6	2,48	104	37,3	2,78	108	33,4	3,24	114	30,5	3,74
	75	80,8	26,1	3,10	79,9	23,5	3,39	82,3	21,0	3,91	83,4	19,2	4,34
	50	54,5	13,9	3,91	53,9	12,4	4,36	53,5	10,9	4,91	53,7	9,8	5,48
	Minimum	19,1	6,39	2,99	20,3	5,72	3,55	21,8	5,10	4,28	22,1	4,40	5,02
50.4	100	114	48,6	2,35	118	37,5	3,15	124	34,3	3,89	125	31,3	4,28
	75	84,0	29,9	2,81	84,4	24,2	3,49	85,7	22,2	3,87	88,0	19,6	4,49
	50	57,5	16,4	3,51	56,3	13,9	4,07	56,2	12,0	4,68	56,5	10,2	5,56
	Minimum	20,4	6,47	3,15	21,7	6,19	3,50	23,3	5,42	4,29	23,4	4,62	5,07
55.4	100	125	53,7	2,33	116	36,5	3,19	115	32,6	3,54	120	29,9	4,03
	75	91,4	32,6	2,80	91,0	27,1	3,36	92,6	24,1	3,85	96,9	22,0	4,42
	50	59,5	16,4	3,64	59,0	14,3	4,12	59,1	12,5	4,71	62,4	11,4	5,50
	Minimum	25,6	7,70	3,32	25,6	6,89	3,71	25,5	6,17	4,14	25,0	5,37	4,66
60.4	100	136	62,9	2,16	129	42,5	3,04	127	37,2	3,41	126	31,7	3,98
	75	98,8	32,2	3,07	95,1	27,2	3,49	94,8	23,9	3,97	94,3	20,4	4,62
	50	66,5	19,4	3,43	64,4	16,2	3,99	64,7	13,9	4,66	64,9	11,7	5,52
	Minimum	22,8	7,29	3,12	25,7	6,96	3,69	25,8	6,10	4,23	26,0	5,26	4,94
65.4	100	146	63,2	2,31	155	53,3	2,91	162	48,9	3,31	168	45,0	3,73
	75	113	36,9	3,07	118	33,4	3,54	124	30,5	4,06	129	28,0	4,60
	50	68,9	20,8	3,31	72,8	18,5	3,94	76,6	16,6	4,61	80,3	15,1	5,30
	Minimum	27,0	8,95	3,02	28,7	8,04	3,57	30,3	7,33	4,14	32,0	6,80	4,71
70.4	100	157	71,2	2,21	165	59,1	2,79	172	54,1	3,18	178	49,5	3,60
	75	121	41,3	2,93	127	37,6	3,37	132	34,3	3,85	137	31,5	4,35
	50	77,8	24,4	3,19	81,9	21,8	3,76	85,9	19,6	4,39	90,0	17,8	5,05
	Minimum	27,0	8,08	3,34	28,6	7,26	3,95	30,3	6,62	4,58	31,9	6,14	5,20
75.4	100	173	68,9	2,52	196	65,7	2,98	203	60,9	3,33	210	56,6	3,71
	75	131	41,6	3,15	147	40,6	3,61	152	37,2	4,10	158	34,1	4,62
	50	83,9	24,8	3,38	87,9	21,9	4,01	91,8	19,4	4,72	95,6	17,4	5,49
	Minimum	30,6	9,46	3,23	32,2	8,34	3,86	33,7	7,41	4,55	35,3	6,67	5,29
80.4	100	189	79,7	2,37	206	72,0	2,86	214	66,7	3,20	221	62,0	3,57
	75	142	48,4	2,93	155	44,1	3,51	161	40,5	3,97	166	37,3	4,46
	50	88,5	26,7	3,31	92,6	23,7	3,91	96,6	21,1	4,58	101	18,9	5,31
	Minimum	31,7	9,85	3,21	33,3	8,70	3,83	34,9	7,75	4,50	36,5	6,98	5,22
85.4	100	208	93,4	2,23	216	78,6	2,75	225	72,9	3,08	233	67,7	3,44
	75	152	53,5	2,83	161	47,5	3,39	167	43,6	3,83	173	40,2	4,30
	50	95,1	29,5	3,22	99,4	26,3	3,78	104	23,5	4,41	108	21,1	5,10
	Minimum	33,8	9,61	3,52	35,5	8,52	4,16	37,1	7,62	4,87	38,7	6,88	5,63

Load = Percentage of cooling capacity compared to full load value

kWf = Cooling capacity in kW

kWe_tot = Total power input in kW

Internal heat exchanger water temperature = outlet 7°C / inlet 12°C / variable flow-rate with external exchanger air T.

General technical data

Performances - Heating

Acoustic configuration Compressor soundproofing (SC) - Silenced (LN) - Super-silenced (EN)

Size D.B./W.B.	Ta (°C)	Leaving internal exchanger water temperature (°C)											
		35		40		45		50		55		60	
		kWt	kWe_tot	kWt	kWe_tot	kWt	kWe_tot	kWt	kWe_tot	kWt	kWe_tot	kWt	kWe_tot
45.4	-20 / -21	54,4	28,1	51,9	29,4	50,1	28,2	-	-	-	-	-	-
	-15 / -16	62,1	29,7	60,0	31,4	58,7	30,4	57,0	32,3	-	-	-	-
	-7 / -8	84,0	30,7	75,8	34,3	74,8	33,7	73,1	35,9	68,5	38,0	-	-
	-4 / -5	87,2	30,0	84,6	32,6	82,3	34,8	80,9	37,1	73,5	40,7	40,4	27,0
	2 / 1	103	31,5	101	34,0	98,4	36,4	96,7	39,0	81,5	45,2	44,8	28,5
	7 / 6	120	32,1	117	34,9	118	37,4	112	40,4	94,2	47,0	51,8	29,6
	12 / 11	137	32,7	134	35,6	131	38,5	128	41,5	108	48,4	59,3	30,5
	18 / 14	155	32,7	152	35,8	147	38,8	144	42,0	121	49,1	66,5	30,9
50.4	-20 / -21	60,1	28,0	57,1	29,3	56,7	32,0	-	-	-	-	-	-
	-15 / -16	67,6	29,7	65,2	31,4	65,6	34,6	63,5	36,7	-	-	-	-
	-7 / -8	89,3	32,8	85,1	38,0	82,8	38,4	81,1	40,9	75,7	42,1	-	-
	-4 / -5	95,0	36,5	93,0	39,2	90,9	39,6	89,2	42,2	82,2	45,6	45,2	28,9
	2 / 1	113	37,8	111	40,8	108	41,5	106	44,5	89,1	48,5	49,0	30,5
	7 / 6	135	37,1	130	39,8	130	42,8	123	46,1	103	50,4	56,5	31,7
	12 / 11	151	37,3	149	40,7	143	44,0	141	47,5	118	52,0	64,7	32,7
	18 / 14	171	37,3	168	40,9	162	44,4	158	48,1	132	52,8	72,6	33,2
55.4	-20 / -21	61,0	34,4	61,2	37,4	61,8	41,1	-	-	-	-	-	-
	-15 / -16	72,4	35,1	72,5	38,2	72,9	42,0	74,3	42,2	-	-	-	-
	-7 / -8	106	38,6	97,8	40,1	97,6	43,8	92,8	43,1	87,5	48,7	-	-
	-4 / -5	113	37,1	107	40,5	107	44,1	101	43,7	91,0	50,0	50,1	32,4
	2 / 1	133	37,6	126	41,4	125	45,1	118	44,5	101	52,4	55,5	33,0
	7 / 6	151	39,8	147	43,3	150	46,9	134	45,2	114	53,3	62,9	33,6
	12 / 11	168	40,0	166	43,8	165	47,8	151	45,8	129	53,9	70,9	34,0
	18 / 14	189	39,8	186	43,7	184	47,7	169	45,8	143	54,0	78,9	34,0
60.4	-20 / -21	77,0	38,8	77,4	42,8	81,6	49,2	-	-	-	-	-	-
	-15 / -16	89,3	40,3	89,7	44,3	94,2	50,6	81,3	55,1	-	-	-	-
	-7 / -8	111	40,6	111	45,0	116	52,2	99,7	56,7	99,7	58,9	-	-
	-4 / -5	121	41,4	120	45,6	126	52,8	108	57,3	108	61,3	59,2	39,8
	2 / 1	140	42,3	140	46,4	146	53,7	125	58,4	117	64,5	64,2	40,6
	7 / 6	163	43,5	159	48,4	170	54,6	141	59,4	140	65,6	77,0	41,3
	12 / 11	193	46,1	192	50,7	187	55,2	159	60,2	149	66,5	82,2	41,9
	18 / 14	217	46,0	215	50,7	209	55,3	177	60,4	167	66,7	91,9	42,0
65.4	-20 / -21	76,0	48,9	79,6	55,6	82,6	61,9	-	-	-	-	-	-
	-15 / -16	94,9	49,1	97,7	55,5	100	61,5	75,9	62,6	-	-	-	-
	-7 / -8	127	46,2	125	55,9	127	61,6	101	61,3	102	59,7	-	-
	-4 / -5	137	50,1	137	56,4	138	61,3	124	60,9	124	65,0	68,4	41,8
	2 / 1	160	51,1	160	56,3	160	61,1	143	60,5	143	65,8	78,5	41,5
	7 / 6	177	47,0	190	57,8	190	59,4	161	60,6	160	65,9	88,0	41,5
	12 / 11	216	51,6	214	58,2	219	63,2	180	60,9	179	66,1	98,2	41,6
	18 / 14	241	51,5	238	58,1	244	63,0	200	60,6	198	65,7	109	41,4
70.4	-20 / -21	81,7	53,3	86,1	60,1	90,8	68,0	-	-	-	-	-	-
	-15 / -16	102	54,0	106	60,4	109	67,9	79,2	68,8	-	-	-	-
	-7 / -8	139	50,5	137	61,2	139	67,5	105	66,7	106	64,7	-	-
	-4 / -5	151	55,5	153	61,3	154	67,2	129	66,2	130	70,7	71,5	45,5
	2 / 1	181	55,8	182	61,2	182	66,9	149	65,8	149	71,5	81,8	45,1
	7 / 6	192	51,8	212	62,8	210	67,0	167	65,9	166	71,6	91,5	45,1
	12 / 11	240	57,9	238	63,3	239	70,3	187	66,2	186	71,8	102	45,2
	18 / 14	268	57,9	266	63,2	266	70,1	207	66,0	205	71,5	113	45,0

kWt = Heating capacity in kW
kWe_tot = Total power input in kW
Ta = Temperature of air entering the external exchanger
D.B. = Dry bulb
W.B. = Wet bulb

Performances - Heating

Acoustic configuration Compressor soundproofing (SC) - Silenced (LN) - Super-silenced (EN)

Size D.B./W.B.	Ta (°C)	Leaving internal exchanger water temperature (°C)											
		35		40		45		50		55		60	
		kWt	kWe_tot	kWt	kWe_tot	kWt	kWe_tot	kWt	kWe_tot	kWt	kWe_tot	kWt	kWe_tot
75.4	-20 / -21	109	48,9	113	55,2	117	61,0	-	-	-	-	-	-
	-15 / -16	125	50,6	128	56,7	130	62,0	98,8	61,4	-	-	-	-
	-7 / -8	146	51,3	153	58,0	155	62,6	124	61,7	124	66,9	-	-
	-4 / -5	165	53,3	165	58,3	166	62,9	150	61,9	151	67,0	83,1	42,2
	2 / 1	192	53,8	191	58,8	191	63,3	171	62,3	171	67,3	94,3	42,4
	7 / 6	208	54,1	227	60,6	230	69,6	192	62,7	192	67,6	105	42,6
	12 / 11	259	54,3	257	60,9	263	65,8	216	63,1	214	68,1	118	42,9
	18 / 14	290	54,3	287	61,0	293	66,0	240	63,5	238	68,6	131	43,2
80.4	-20 / -21	116	53,8	127	63,4	131	69,3	-	-	-	-	-	-
	-15 / -16	130	54,9	142	64,9	144	69,8	109	68,9	-	-	-	-
	-7 / -8	159	57,0	168	65,7	169	70,6	136	69,4	134	76,3	-	-
	-4 / -5	180	60,6	181	66,2	182	71,0	164	69,7	165	75,1	90,7	47,3
	2 / 1	209	61,4	209	66,9	208	71,7	186	70,2	186	75,5	103	47,5
	7 / 6	224	59,4	247	69,0	250	78,7	209	70,8	208	76,1	115	47,9
	12 / 11	282	67,4	279	69,6	272	77,9	235	71,5	233	76,9	128	48,4
	18 / 14	317	67,4	313	69,8	304	78,2	262	71,9	259	77,4	143	48,8
85.4	-20 / -21	126	64,0	132	71,4	137	77,8	-	-	-	-	-	-
	-15 / -16	145	66,3	149	72,2	153	78,5	119	76,5	-	-	-	-
	-7 / -8	168	70,6	170	73,3	172	79,3	146	77,2	147	83,9	-	-
	-4 / -5	190	68,2	191	73,9	193	79,8	176	77,6	178	83,4	97,7	52,6
	2 / 1	220	69,2	220	74,8	220	80,7	200	78,4	200	84,2	110	53,0
	7 / 6	240	65,2	284	77,3	268	87,5	224	79,2	223	85,0	123	53,5
	12 / 11	324	72,3	321	78,1	321	85,9	251	80,1	249	86,0	137	54,2
	18 / 14	364	72,5	360	78,5	360	86,4	280	80,7	277	86,7	153	54,6

kWt = Heating capacity in kW

kWe_tot = Total power input in kW

Ta = Temperature of air entering the external exchanger

D.B. = Dry bulb

W.B. = Wet bulb

Integrated heating capacities

External exchanger inlet air temperature °C (D.B./W.B.)	-7/-8	-5/-6	0/-1	2/1	Other
Heating capacity multiplication coefficient	0,90	0,89	0,88	0,90	1,00

The integrated heating capacity is the actual heating capacity, including the impact of any defrosting cycles.

To obtain the integrated heating capacity multiply the heating performance value in kWt (shown in the heating performance tables) by the coefficients indicated in the table.

In prolonged heat pump operating mode with negative ambient temperature, it is important to drain the water produced by the defrosting cycles to prevent the build-up of ice near the base of the unit. Ensure this does not pose a danger to property or persons.

General technical data

Performances - Heating at partial load

Acoustic configuration Compressor soundproofing (SC) - Silenced (LN) - Super-silenced (EN)

Size	Load	Entering external exchanger air temperature (°C)																	
		-20 / -21			-15 / -16			-10 / -11			-7 / -8			2 / 1			7 / 6		
		kWt	kWe_tot	COP	kWt	kWe_tot	COP	kWt	kWe_tot	COP	kWt	kWe_tot	COP	kWt	kWe_tot	COP	kWt	kWe_tot	COP
45.4	100	50,1	28,2	1,77	58,7	30,4	1,93	68,3	32,4	2,11	74,8	33,7	2,22	98,4	36,4	2,70	118	37,4	3,15
	75	34,9	20,8	1,67	43,1	22,3	1,93	51,9	23,7	2,19	57,6	24,5	2,35	77,3	26,9	2,87	89,9	27,9	3,23
	50	18,6	12,2	1,53	24,3	13,1	1,85	30,2	14,0	2,16	33,8	14,4	2,34	46,2	15,8	2,93	53,6	16,4	3,27
	Minimum	6,62	4,83	1,37	8,80	5,20	1,69	11,0	5,53	1,99	12,3	5,70	2,16	16,9	6,14	2,75	19,5	6,32	3,09
50.4	100	56,7	32,0	1,77	65,6	34,6	1,90	75,7	37,0	2,05	82,8	38,4	2,16	108	41,5	2,61	130	42,8	3,03
	75	37,1	21,7	1,71	45,5	23,3	1,96	54,5	24,7	2,21	60,4	25,6	2,36	80,8	28,0	2,88	93,9	28,9	3,24
	50	21,3	14,9	1,43	27,7	16,0	1,73	34,3	17,1	2,01	38,3	17,6	2,17	52,4	19,2	2,72	56,0	17,7	3,17
	Minimum	7,29	5,19	1,41	9,65	5,57	1,73	12,0	5,91	2,04	13,5	6,09	2,21	18,3	6,57	2,79	21,2	6,76	3,13
55.4	100	61,8	41,1	1,50	72,9	42,0	1,74	84,4	43,0	1,96	97,6	43,8	2,23	125	45,1	2,77	150	46,9	3,19
	75	46,6	28,2	1,65	56,0	28,5	1,97	65,7	28,9	2,27	72,1	29,2	2,47	93,0	30,5	3,05	106	31,1	3,42
	50	27,4	17,6	1,56	33,2	17,6	1,89	39,1	17,7	2,22	42,8	17,8	2,41	55,2	18,3	3,02	62,9	18,7	3,37
	Minimum	10,0	6,51	1,54	11,9	6,57	1,82	13,9	6,65	2,09	15,1	6,72	2,25	19,7	6,96	2,83	22,4	7,11	3,15
60.4	100	81,6	49,2	1,66	94,2	50,6	1,86	107	51,5	2,08	116	52,2	2,22	146	53,7	2,72	170	54,6	3,11
	75	55,7	34,2	1,63	66,5	34,8	1,91	77,6	35,5	2,19	84,9	35,9	2,36	109	37,2	2,93	124	37,8	3,29
	50	34,9	24,4	1,43	42,2	24,5	1,73	49,8	24,7	2,02	54,6	24,8	2,20	70,7	25,7	2,75	74,3	23,3	3,18
	Minimum	12,5	8,02	1,56	14,9	8,06	1,85	17,4	8,15	2,14	19,1	8,23	2,32	24,5	8,53	2,88	28,0	8,72	3,21
65.4	100	82,6	61,9	1,33	99,5	61,5	1,62	116	61,5	1,89	127	61,6	2,05	160	61,1	2,61	190	59,4	3,19
	75	61,5	38,2	1,61	73,8	37,3	1,98	85,8	36,6	2,35	93,6	36,5	2,57	123	36,9	3,34	142	40,5	3,51
	50	41,9	26,4	1,58	49,1	25,2	1,95	56,4	24,5	2,30	61,1	24,2	2,53	79,6	24,0	3,32	91,6	20,2	4,52
	Minimum	17,7	11,8	1,50	20,4	11,3	1,81	23,1	10,9	2,11	24,7	10,8	2,29	31,7	10,6	2,98	36,2	8,91	4,06
70.4	100	90,8	68,0	1,34	109	67,9	1,61	128	68,2	1,87	139	67,5	2,06	182	66,9	2,72	210	67,0	3,13
	75	64,5	40,9	1,58	77,5	40,0	1,94	90,2	39,3	2,29	98,4	39,3	2,51	130	39,7	3,27	150	43,4	3,45
	50	43,5	27,5	1,58	51,2	26,3	1,94	58,8	25,5	2,30	63,9	25,2	2,53	83,5	25,1	3,33	96,0	21,2	4,53
	Minimum	18,5	12,4	1,49	21,4	11,9	1,81	24,4	11,5	2,12	26,2	11,4	2,31	33,8	11,2	3,01	38,7	9,43	4,10
75.4	100	117	61,0	1,92	130	62,0	2,10	145	62,4	2,32	155	62,6	2,47	191	63,3	3,02	230	69,6	3,30
	75	80,7	38,0	2,12	92,2	38,7	2,38	105	39,3	2,67	113	39,8	2,84	147	40,4	3,65	170	44,0	3,86
	50	48,8	26,4	1,85	57,0	26,7	2,14	65,7	27,0	2,44	71,5	27,1	2,64	94,2	27,5	3,42	109	23,2	4,67
	Minimum	19,4	12,0	1,61	22,9	12,1	1,89	26,5	12,2	2,17	28,8	12,2	2,36	37,9	12,2	3,11	43,6	10,2	4,29
80.4	100	131	69,3	1,89	144	69,8	2,06	159	70,3	2,26	169	70,6	2,40	208	71,7	2,91	250	78,7	3,17
	75	88,0	41,2	2,14	99,9	42,1	2,37	113	42,8	2,64	122	43,2	2,82	158	43,6	3,62	182	47,6	3,82
	50	53,1	28,5	1,86	61,8	28,9	2,14	71,2	29,3	2,43	77,3	29,5	2,62	102	30,1	3,38	117	25,5	4,59
	Minimum	20,8	15,5	1,34	24,5	15,7	1,56	28,3	15,9	1,78	30,8	16,0	1,92	40,6	16,3	2,49	46,7	13,8	3,39
85.4	100	137	77,8	1,76	153	78,5	1,95	167	79,2	2,11	172	79,3	2,16	220	80,7	2,72	268	87,5	3,06
	75	98,8	47,0	2,10	111	48,1	2,31	125	48,5	2,57	134	48,9	2,74	173	49,2	3,52	200	53,8	3,71
	50	59,1	31,5	1,87	68,5	32,0	2,14	78,5	32,5	2,41	85,1	32,8	2,59	112	33,7	3,31	129	28,6	4,50
	Minimum	22,9	13,7	1,67	26,9	13,9	1,94	31,0	14,0	2,22	33,8	14,0	2,41	44,5	14,2	3,14	51,3	11,9	4,30

Load = Percentage of cooling capacity compared to the value at full load

kWt = Heating capacity (kW)

kWe_tot = Total power input in kW

Internal heat exchanger water temperature = outlet 45°C / inlet 40°C / Variable flow-rate with external exchanger air T

D - Partial energy recovery

A configuration which enables the production of hot water free-of-charge while operating in the cooling mode, thanks to the partial recovery of condensation heat that would otherwise be disposed of into the external heat source.

This option is also known as “desuperheater”. It is made up of a Inox 316 stainless steel brazed plate heat exchangers, suitable for recovering a part of the capacity dispersed by the unit (the dispersed heating capacity is equal to the sum of the cooling capacity and the electrical input capacity of the compressors).

The partial recovery device is considered to be operating when it is powered by the water flow which is to be heated. This condition improves the unit performance, since it reduces the condensation temperature: in nominal conditions the cooling capacity increases indicatively by 3.2% and the power input of the compressors is reduced by 3.6%.

When the temperature of water to be heated is particularly low, it is necessary to control the flow-rate to maintain the outlet temperature at recovery above 35°C and prevent condensation of the refrigerant in the partial energy recovery device.

The water connections of the partial energy recovery device are 1” 1/4 for all sizes.

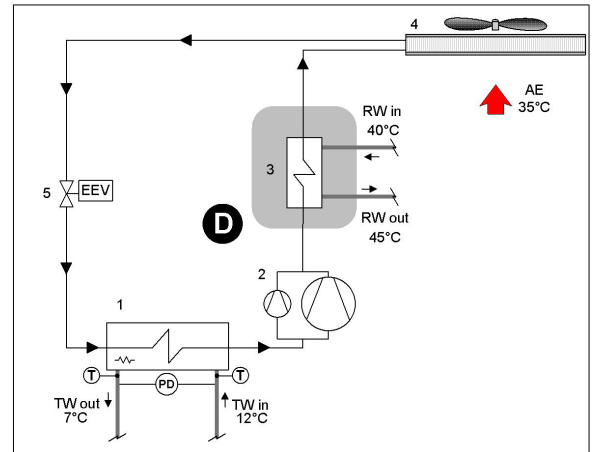

D - Partial recovery device

- 1 - Internal exchanger
- 2 - Compressors
- 3 - Recovery exchanger
- 4 - External exchanger
- 5 - Electronic expansion valve

- TW in Chilled water inlet
- TW out Chilled water outlet
- RW in - Ingresso acqua recupero
- RW out - Uscita acqua recupero
- T - Temperature probe
- PD - Differential pressure switch
- AE Aria esterna

Partial recovery heating capacity

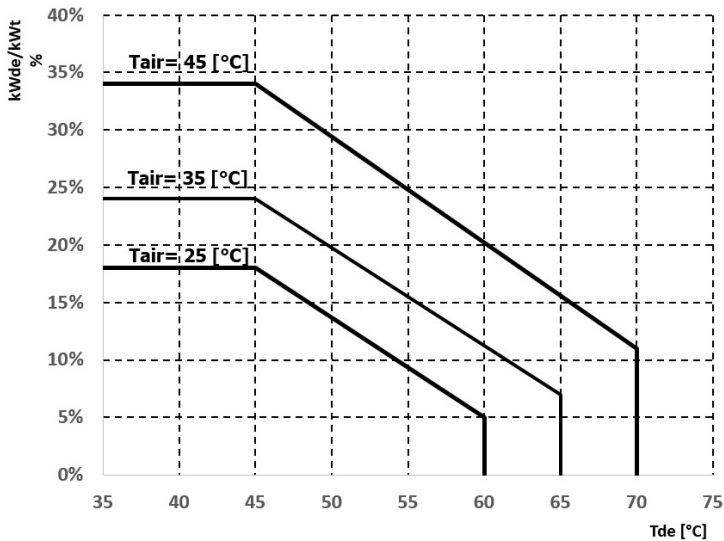

$kWde/kWf$ = Heat recovered / Condenser heating capacity (cooling capacity + compressor power input) [%]
 Tde = Desuperheater water outlet temperature [°C]

Configurations

Partial energy recovery exchanger pressure drops

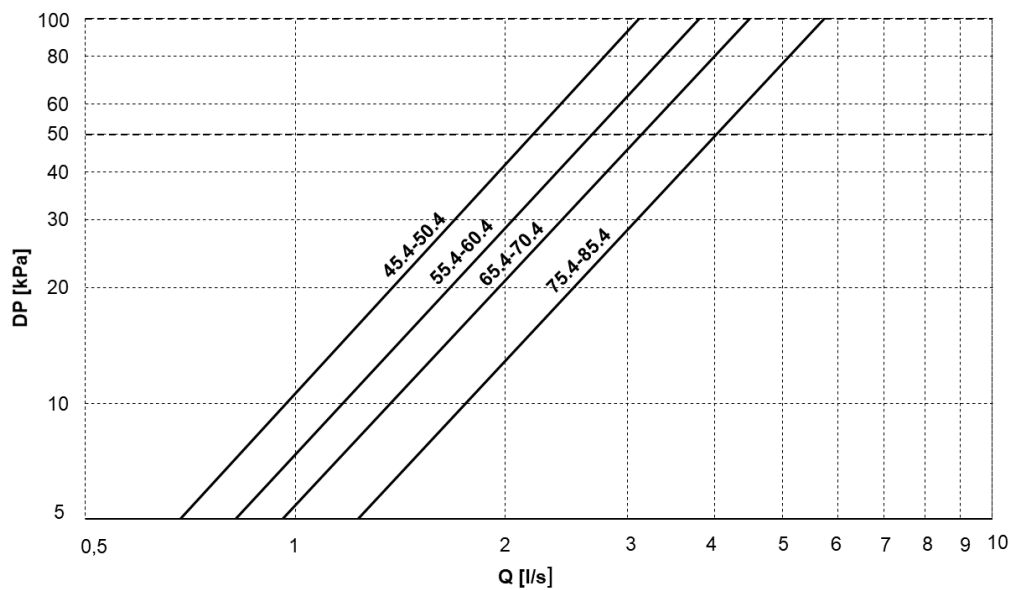

Q = Water flow rate [l/s]

DP = Water side pressure drops [kPa]

Admissible water flow rates

Minimum (Qmin) and maximum (Qmax) admissible water flow rates for correct operation of the unit.

SIZE		45.4	50.4	55.4	60.4	65.4	70.4	75.4	80.4	85.4
Qmin	[l/s]	2,5	2,5	3,0	3,0	3,4	3,4	4,4	4,4	4,4
Qmax	[l/s]	11,2	11,2	13,7	13,7	16,2	16,2	20,7	20,7	20,7

1PM - HydroPack with N° 1 pump

Pumping group consisting of an electric centrifugal pump with cast iron pump body and stainless steel or cast iron impeller (depending on the model).

Mechanical seal using ceramic, carbon and EPDM elastomer components.

Three-phase electric motor with IP55 protection rating. Complete with thermoformed insulating casing, quick-release couplings with an insulated casing, safety valve, pressure gauges, system load safety pressure switch, stainless steel immersion antifreeze heaters fitted on the supply and suction lines.

All the water connections are Victaulic.

Option supplied on the unit.

CONNECTION DIAGRAM 1PM - Group with n° 1 pump

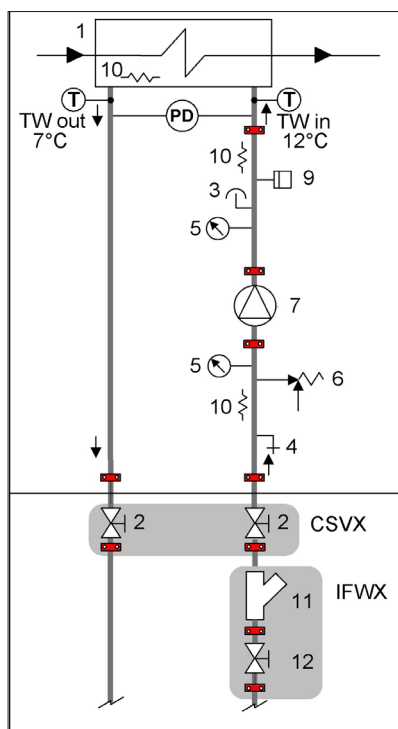

- 1 - Internal exchanger
- 2 - Cutoff valve - (CSVX Couple of manually operated shut-off valves)
- 3 - Purge valve
- 4 - Discharge stop valve
- 5 - Pressure gauge
- 6 - Safety valve (6 Bar)
- 7 - Packaged electric pump with high efficiency impeller
- 9 - System load safety pressure switch (it avoids the pump operation if water is not present)
- 10 - Antifreeze heater
- 11 - Steel mesh strainer water side (IFWX)
- 12 - Cutoff valve with quick joints

T - Temperature probe
PD - Differential pressure switch

TW in Chilled water inlet
TW out Chilled water outlet

The grey area indicates further optional components.

- ⚠ Provide hydraulic shut-off valves outside the unit (option: 'CSVX - Pair of manually operated shut-off valves') to facilitate any extraordinary maintenance operations.
- ⚠ **It is necessary to provide a non-return valve for each unit installed in hydraulic parallel and equipped with an hydronic assembly installed on board (Installation by the Customer).**

Hydropack electrical data

PUMP	Nominal capacity [kW]	Rated current input [A]
1PM 45.4-60.4	1,5	3,17
1PM 65.4-80.4	2,2	4,56
1PM 85.4	3,0	6,33

Accessories - Hydronic assembly

1PM - HydroPack with N° 1 pump

Head

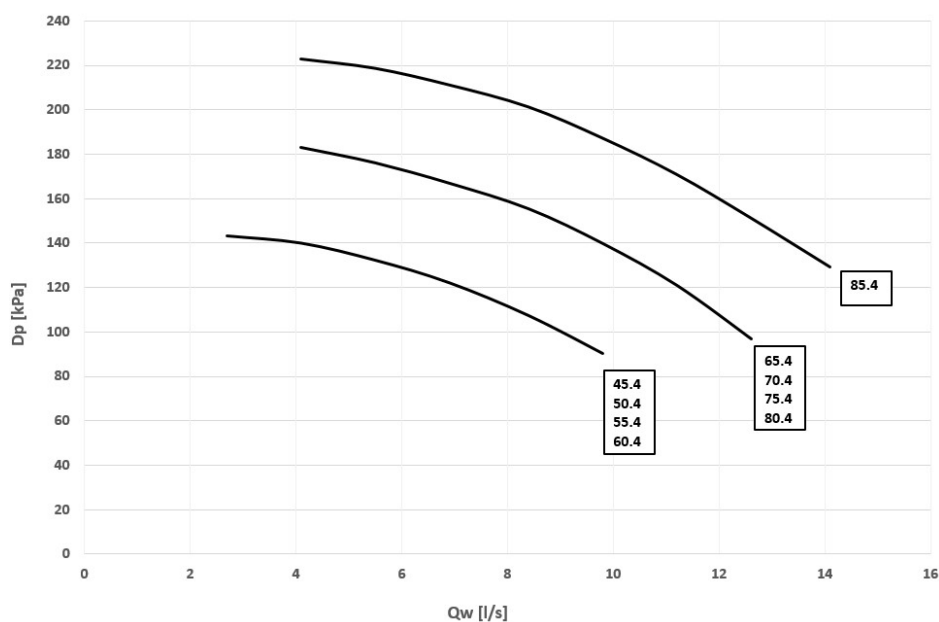

Dp = Pump head [kPa]
QW = Water flow-rate [l/s]

Power input

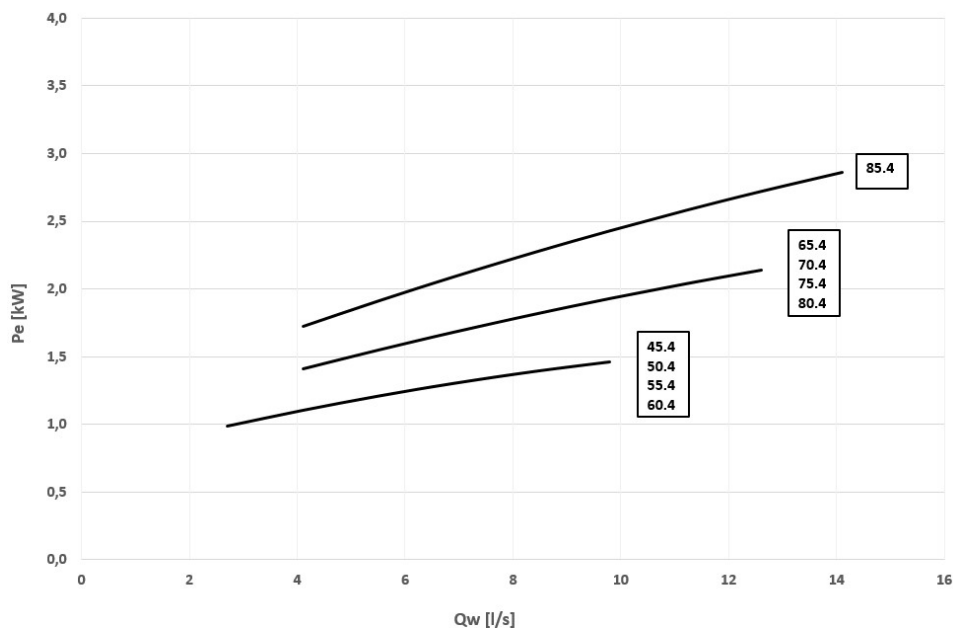

Pe = Power input [kW]
QW = Water flow-rate [l/s]

1PMH - HydroPack with N° 1 high static pressure pump

Pumping group consisting of an electric centrifugal pump with cast iron pump body and stainless steel or cast iron impeller (depending on the model).

Mechanical seal using ceramic, carbon and EPDM elastomer components.

Three-phase electric motor with IP55 protection rating. Complete with thermoformed insulating casing, quick-release couplings with an insulated casing, safety valve, pressure gauges, system load safety pressure switch, stainless steel immersion antifreeze heaters fitted on the supply and suction lines.

All water fittings are Victaulic.

Option supplied on the unit.

CONNECTION DIAGRAM 1PMH - Group with 1 high head pump

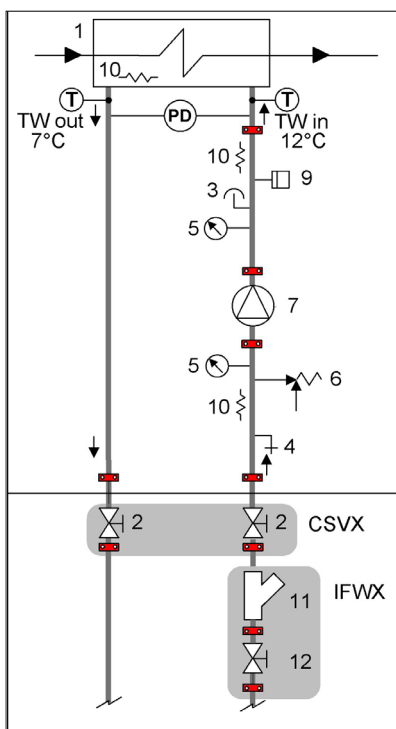

- 1 - Internal exchanger
- 2 - Cutoff valve - (CSVX Couple of manually operated shut-off valves)
- 3 - Purge valve
- 4 - Discharge stop valve
- 5 - Pressure gauge
- 6 - Safety valve (6 Bar)
- 7 - Packaged electric pump with high efficiency impeller
- 9 - System load safety pressure switch (it avoids the pump operation if water is not present)
- 10 - Antifreeze heater
- 11 - Steel mesh strainer water side (IFWX)
- 12 - Cutoff valve with quick joints

T - Temperature probe
PD - Differential pressure switch

TW in Chilled water inlet
TW out Chilled water outlet

The grey area indicates further optional components.

- ⚠ Provide hydraulic shut-off valves outside the unit (option: 'CSVX - Pair of manually operated shut-off valves') to facilitate any extraordinary maintenance operations.
- ⚠ **It is necessary to provide a non-return valve for each unit installed in hydraulic parallel and equipped with an hydronic assembly installed on board (Installation by the Customer).**

Hydropack electrical data

POMPA	Potenza nominale [kW]	Corrente assorbita nominale [A]
1PMH 45.4-60.4	3,0	6,33
1PMH 65.4-85.4	4,0	7,62

Accessories - Hydronic assembly

1PMH - HydroPack with N° 1 high static pressure pump

Head

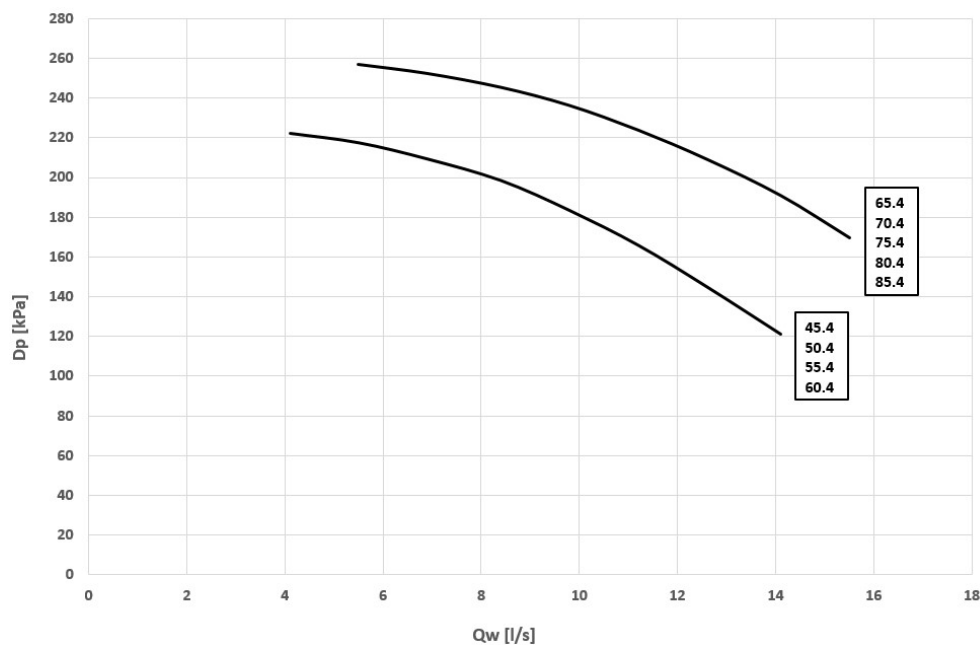

Dp = Pump head [kPa]
QW = Water flow-rate [l/s]

Power input

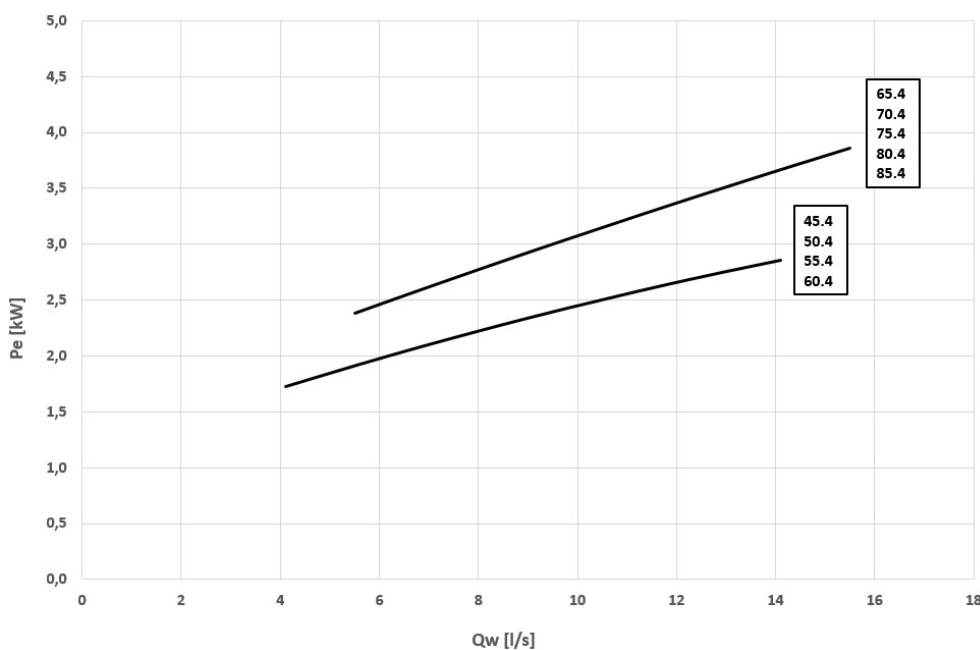

Pe = Power input [kW]
QW = Water flow-rate [l/s]

1PMV - User side Hydropack with 1 inverter pump

Pumping group consisting of an electric pump controlled by inverter to adapt to different conditions of use.

Automatically reduces the liquid flow-rate in critical conditions, thereby preventing overloading blockages and the subsequent intervention of specialised technical personnel.

The pump flow-rate/head can be adapted to the system features by calibrating the inverter, which is standard supplied.

Electric centrifugal pump with cast iron pump body and stainless steel or cast iron impeller (depending on the model).

Mechanical seal using ceramic, carbon and EPDM elastomer components.

Three-phase electric motor with IP55 protection rating. Complete with thermoformed insulating casing, quick-release couplings with an insulated casing, safety valve, pressure gauges, system load safety pressure switch, stainless steel immersion antifreeze heaters fitted on the suction and supply lines.

In combination with the "IVFDT" - Variable flow-rate control option, it allows variation of the water flow-rate to the system under partial-load to achieve the highest unit efficiency and lower consumption of the pumping group.

All water fittings are Victaulic.

Option supplied on the unit.

CONNECTION DIAGRAM 1PMV - Group with n° 1 inverter pump

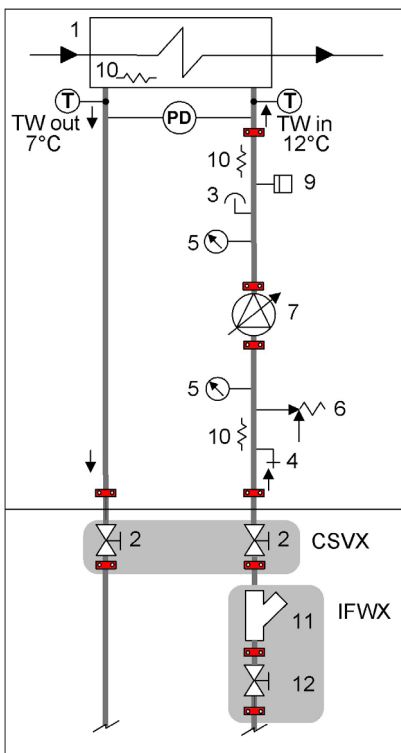

- 1 - Internal exchanger
- 2 - Cutoff valve - (CSVX Couple of manually operated shut-off valves)
- 3 - Purge valve
- 4 - Discharge stop valve
- 5 - Pressure gauge
- 6 - Safety valve (6 Bar)
- 7 - Packaged electric pump with high efficiency impeller
- 9 - System load safety pressure switch (it avoids the pump operation if water is not present)
- 10 - Antifreeze heater
- 11 - Steel mesh strainer water side (IFWX)
- 12 - Cutoff valve with quick joints

T - Temperature probe
PD - Differential pressure switch

TW in Chilled water inlet
TW out Chilled water outlet

The grey area indicates further optional components.

- ⚠ Provide hydraulic shut-off valves outside the unit (option: 'CSVX - Pair of manually operated shut-off valves') to facilitate any extraordinary maintenance operations.
- ⚠ It is necessary to provide a non-return valve for each unit installed in hydraulic parallel and equipped with an hydronic assembly installed on board (Installation by the Customer).

Hydropack electrical data

POMPA	Potenza nominale [kW]	Corrente assorbita nominale [A]
1PMV 45.4-60.4	1,5	3,17
1PMV 65.4-80.4	2,2	4,56
1PMV 85.4	3,0	6,33

Accessories - Hydronic assembly

1PMV - User side Hydropack with 1 inverter pump

Head - Size 45.4 - 60.4

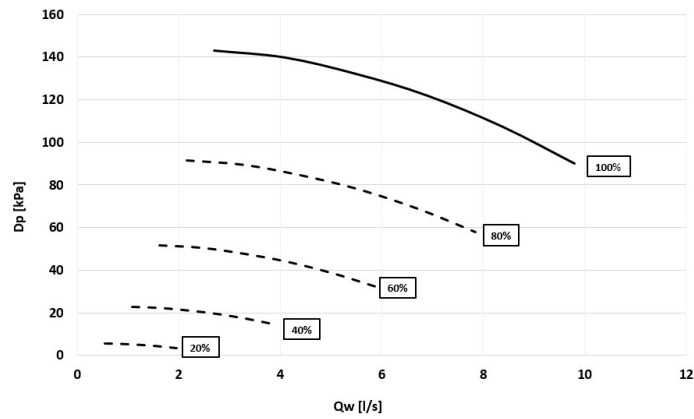

Dp = Pump head [kPa]
QW = Water flow-rate [l/s]

Power input - Size 45.4 - 60.4

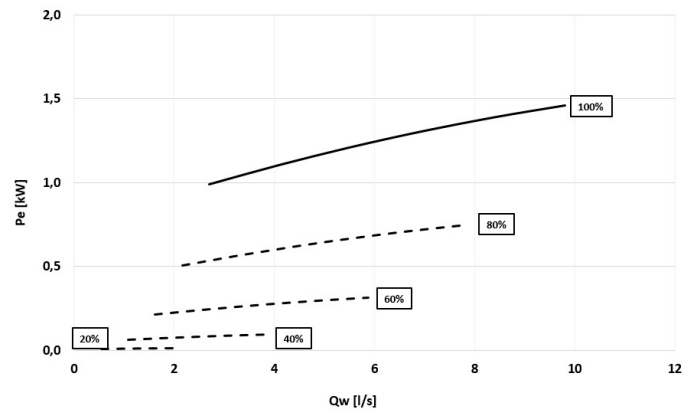

Pe = Power input [kW]
QW = Water flow-rate [l/s]

Head - Size 65.4 - 80.4

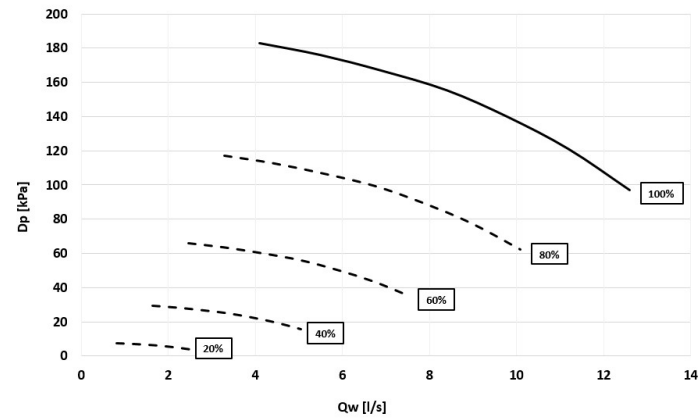

Dp = Pump head [kPa]
QW = Water flow-rate [l/s]

Power input - Size 65.4 - 80.4

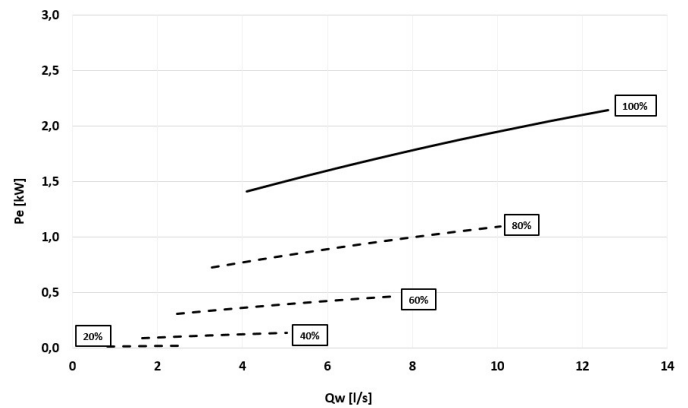

Pe = Power input [kW]
QW = Water flow-rate [l/s]

Head - Size 85.4

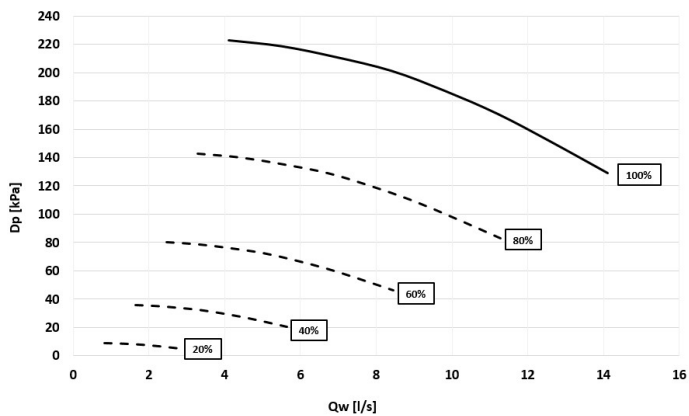

Dp = Pump head [kPa]
QW = Water flow-rate [l/s]

Power input - Size 85.4

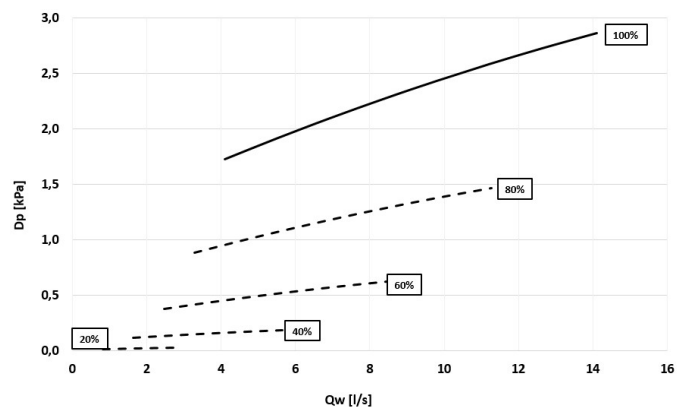

Pe = Power input [kW]
QW = Water flow-rate [l/s]

1PMVH - User side Hydropack with 1 high head inverter pump

Pumping group consisting of an electric pump controlled by inverter to adapt to different conditions of use.

Automatically reduces the liquid flow-rate in critical conditions, thereby preventing overloading blockages and the subsequent intervention of specialised technical personnel.

The pump flow-rate/head can be adapted to the system features by calibrating the inverter, which is standard supplied.

Electric centrifugal pump with cast iron pump body and stainless steel or cast iron impeller (depending on the model).

Mechanical seal using ceramic, carbon and EPDM elastomer components.

Three-phase electric motor with IP55 protection rating. Complete with thermoformed insulating casing, quick-release couplings with an insulated casing, safety valve, pressure gauges, system load safety pressure switch, stainless steel immersion antifreeze heaters fitted on the suction and supply lines.

In combination with the "IVFDT" - Variable flow-rate control option, it allows variation of the water flow-rate to the system under partial-load to achieve the highest unit efficiency and lower consumption of the pumping group.

All water fittings are Victaulic.

Option supplied on the unit.

CONNECTION DIAGRAM 1PMVH - Group with 1 inverter pump

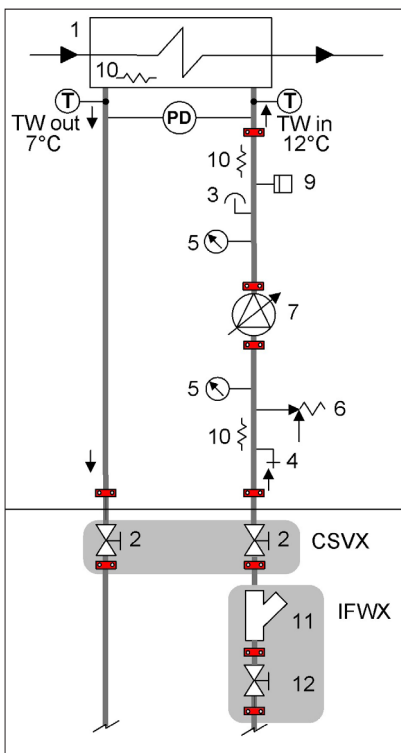

- 1 - Internal exchanger
- 2 - Cutoff valve - (CSVX Couple of manually operated shut-off valves)
- 3 - Purge valve
- 4 - Discharge stop valve
- 5 - Pressure gauge
- 6 - Safety valve (6 Bar)
- 7 - Packaged electric pump with high efficiency impeller
- 9 - System load safety pressure switch (it avoids the pump operation if water is not present)
- 10 - Antifreeze heater
- 11 - Steel mesh strainer water side (IFWX)
- 12 - Cutoff valve with quick joints

T - Temperature probe
PD - Differential pressure switch

TW in Chilled water inlet
TW out Chilled water outlet

The grey area indicates further optional components.

- ⚠ Provide hydraulic shut-off valves outside the unit (option: 'CSVX - Pair of manually operated shut-off valves') to facilitate any extraordinary maintenance operations.
- ⚠ It is necessary to provide a non-return valve for each unit installed in hydraulic parallel and equipped with an hydronic assembly installed on board (Installation by the Customer).

Hydropack electrical data

POMPA	Potenza nominale [kW]	Corrente assorbita nominale [A]
1PMVH 45.4-60.4	3,0	6,33
1PMVH 65.4-85.4	4,0	7,62

Accessories - Hydronic assembly

1PMVH - User side Hydropack with 1 high head inverter pump

Head - Size 45.4 - 60.4

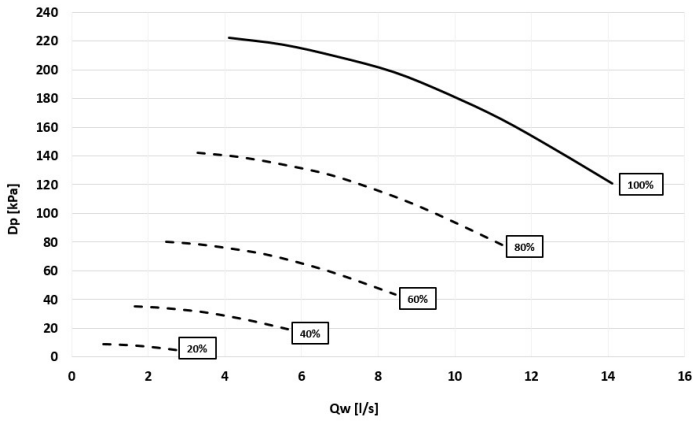

Dp = Pump head [kPa]
QW = Water flow-rate [l/s]

Power input - Size 45.4 - 60.4

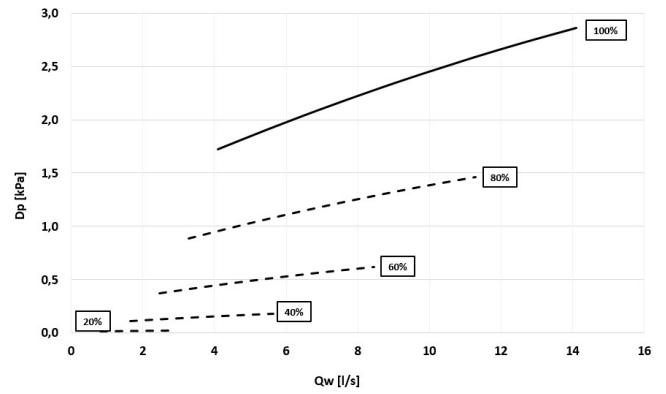

Pe = Power input [kW]
QW = Water flow-rate [l/s]

Head - Size 65.4 - 85.4

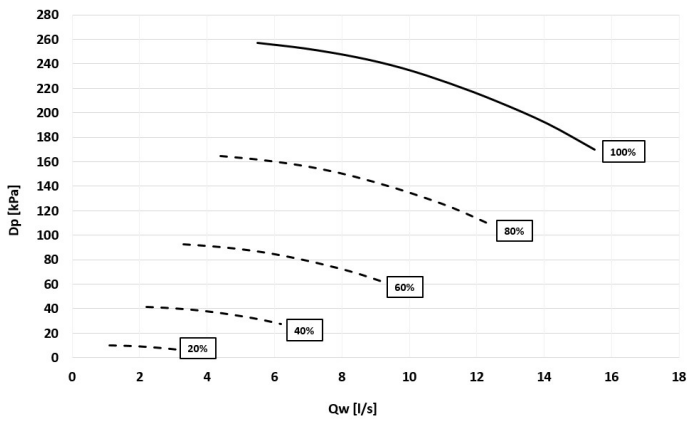

Dp = Pump head [kPa]
QW = Water flow-rate [l/s]

Power input - Size 65.4 - 85.4

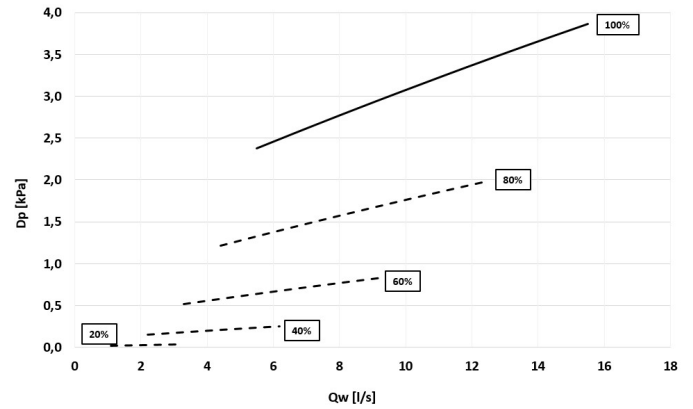

Pe = Power input [kW]
QW = Water flow-rate [l/s]

1P1SB - Hydropack with 1 pump + 1 stand-by

Pumping group consisting of 1+1 electric pump (1 stand-by) with cast iron pump body and stainless steel or cast iron impeller (depending on the model). Mechanical seal using ceramic, carbon and EPDM elastomer components.

Three-phase electric motor with IP55 protection rating. Complete with thermoformed insulating casing, quick-release couplings with an insulated casing, safety valve, pressure gauges, system load safety pressure switch, stainless steel immersion antifreeze heaters fitted on the supply and suction lines.

All water fittings are Victaulic.

Option supplied on the unit.

CONNECTION DIAGRAM 1P1SB - Hydropack with 1 pump + 1 stand-by

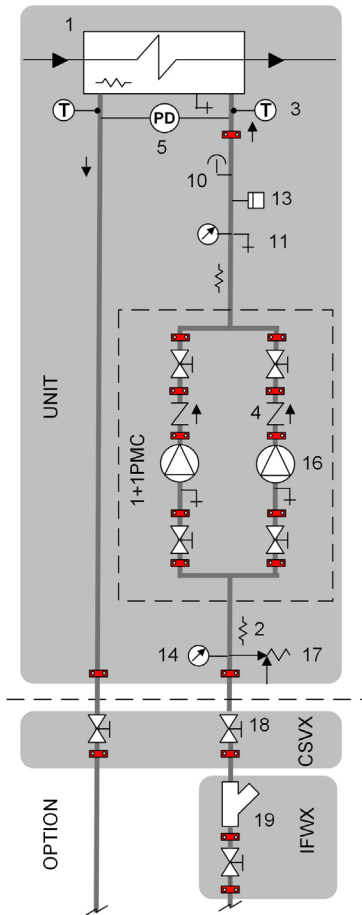

1. Exchanger
2. Antifreeze heater
3. Water temperature probe
4. Non return valve
5. Differential pressure switch
10. Vent
11. Drain
13. System load safety pressure switch
14. Pressure gauge
16. Packaged electric pump with high efficiency impeller
17. Pressure relief valve
18. Shut-off valve
19. Filter

T - Temperature probe
PD - Differential pressure switch

TW in Chilled water inlet
TW out Chilled water outlet

- ⚠ Provide hydraulic shut-off valves outside the unit (option: 'CSVX - Pair of manually operated shut-off valves') to facilitate any extraordinary maintenance operations.
- ⚠ The head and consumption graphs of the pumping group refer to operation with pure water. If there is a water-glycol mix, please contact Clivet's office to check the correct operating point of the pumping group.

Hydropack electrical data

PUMP	Nominal capacity [kW]	Rated current input [A]
1P1SB 45.4-60.4	1,5	3,17
1P1SB 65.4-80.4	2,2	4,56
1P1SB 85.4	3,0	6,33

Accessories - Hydronic assembly

1P1SB - Hydropack with 1 pump + 1 standby

Head

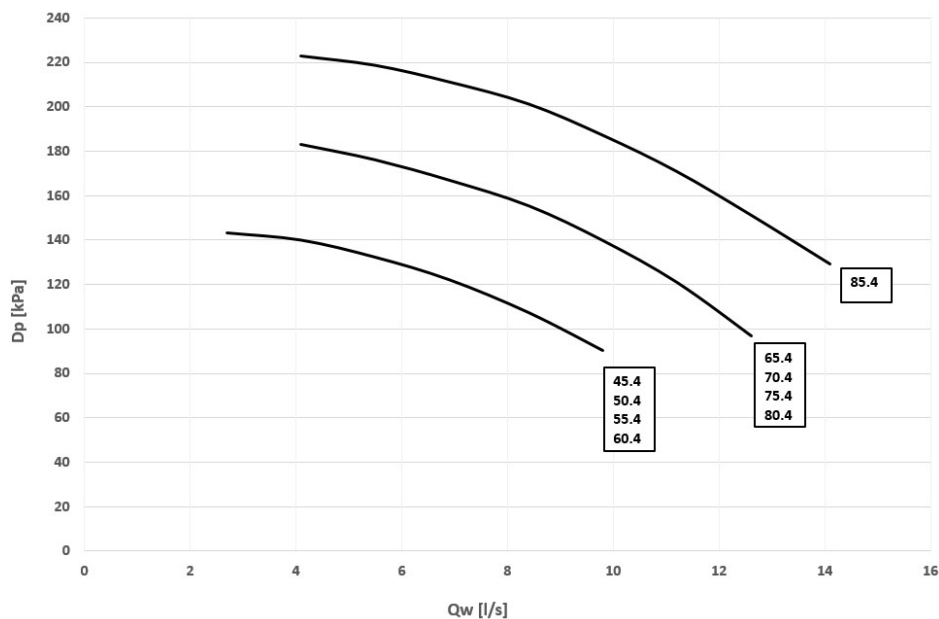

Dp = Pump head [kPa]
QW = Water flow-rate [l/s]

Power input

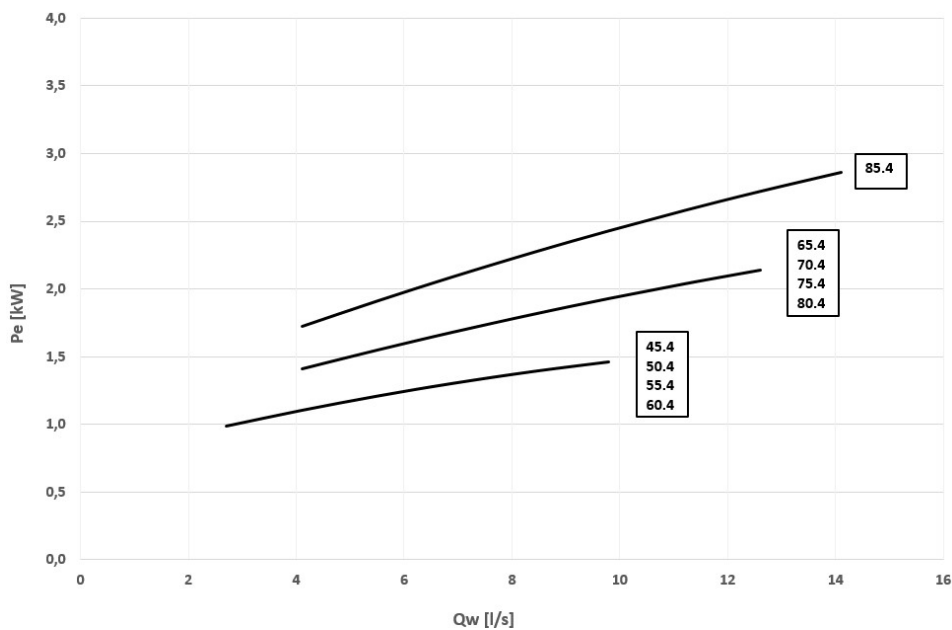

Pe = Power input [kW]
QW = Water flow-rate [l/s]

1PAP+S - Hydropack with 1 high head pump + 1 standby

Pumping group consisting of 1+1 electric pump (1 stand-by) with cast iron pump body and stainless steel or cast iron impeller (depending on the model). Mechanical seal using ceramic, carbon and EPDM elastomer components.

Three-phase electric motor with IP55 protection rating. Complete with thermoformed insulating casing, quick-release couplings with an insulated casing, safety valve, pressure gauges, system load safety pressure switch, stainless steel immersion antifreeze heaters fitted on the supply and suction lines.

All water fittings are Victaulic.

Option supplied on the unit.

CONNECTION DIAGRAM 1PAP+S - Group with 1 high head pump + 1 standby

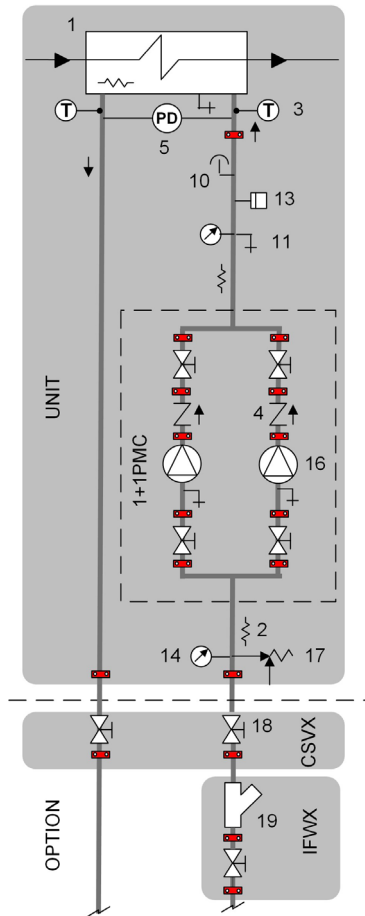

1. Exchanger
2. Antifreeze heater
3. Water temperature probe
4. Non return valve
5. Differential pressure switch
10. Vent
11. Drain
13. System load safety pressure switch
14. Pressure gauge
16. Packaged electric pump with high efficiency impeller
17. Pressure relief valve
18. Shut-off valve
19. Filter

T - Temperature probe
PD - Differential pressure switch

TW in Chilled water inlet
TW out Chilled water outlet

⚠ Provide hydraulic shut-off valves outside the unit (option: 'CSVX - Pair of manually operated shut-off valves') to facilitate any extraordinary maintenance operations.

⚠ The head and consumption graphs of the pumping group refer to operation with pure water. If there is a water-glycol mix, please contact Clivet's office to check the correct operating point of the pumping group.

Hydropack electrical data

PUMP	Nominal capacity [kW]	Rated current input [A]
1PAP+S 45.4-60.4	3,0	6,33
1PAP+S 65.4-85.4	4,0	7,62

Accessories - Hydronic assembly

1PAP+S - Hydropack with 1 high head pump + 1 standby

Head

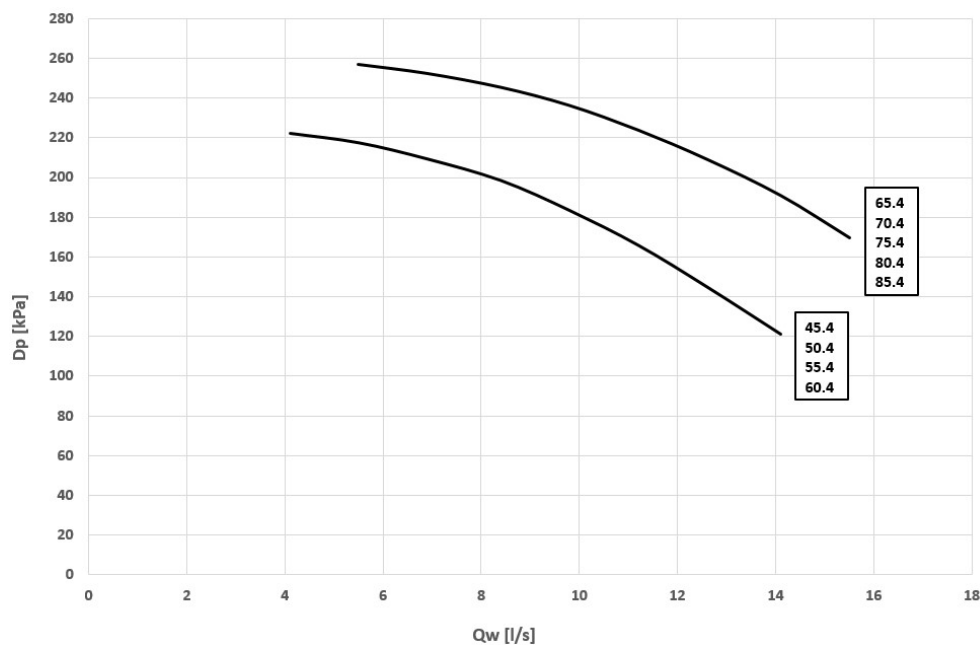

Dp = Pump head [kPa]
QW = Water flow-rate [l/s]

Power input

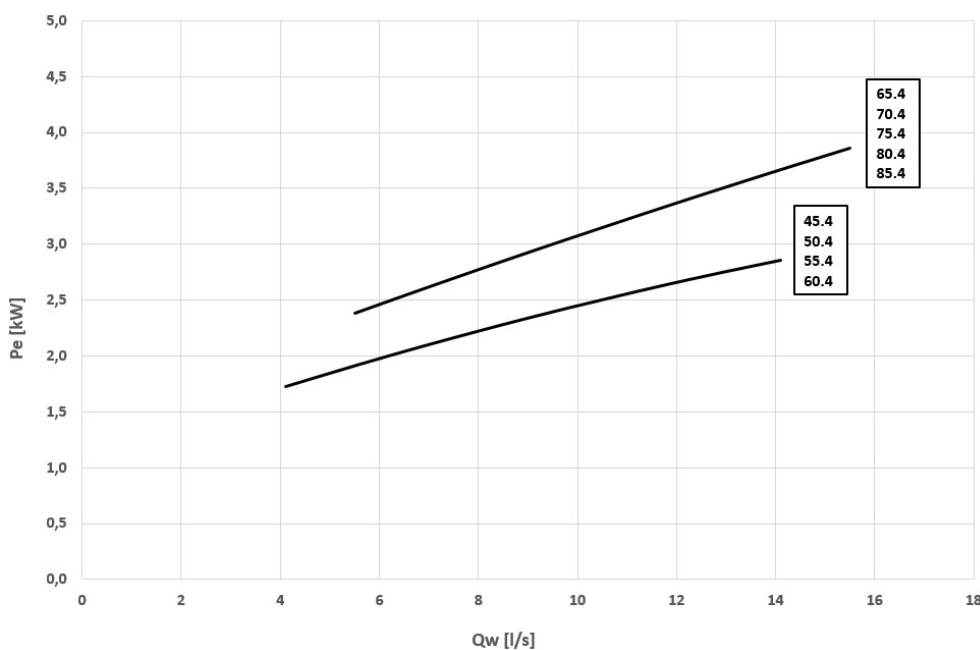

Pe = Power input [kW]
QW = Water flow-rate [l/s]

1P1SBV - User side Hydropack with 1 inverter pump and 1 stand-by pump with dedicated inverter

Pumping group consisting of 1+1 electric pump (1 stand-by) with cast iron pump body and stainless steel or cast iron impeller (depending on the model). Mechanical seal using ceramic, carbon and EPDM elastomer components.

Three-phase electric motor with IP55 protection rating. Complete with thermoformed insulating casing, quick-release couplings with an insulated casing, safety valve, pressure gauges, system load safety pressure switch, stainless steel immersion antifreeze heaters fitted on the supply and suction lines.

All water fittings are Victaulic.

Option supplied on the unit.

CONNECTION DIAGRAM 1P1SBV - Group with 1 inverter pump and 1 stand-by pump with dedicated inverter

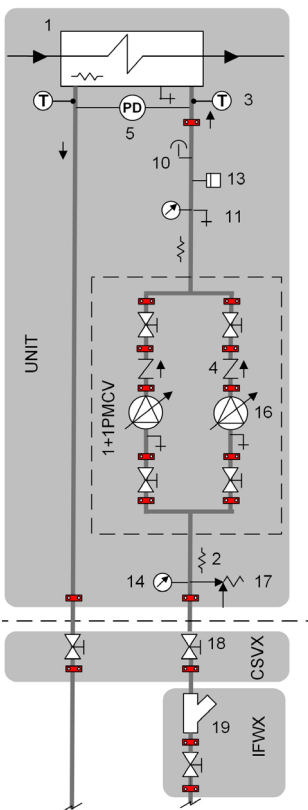

1. Exchanger
2. Antifreeze heater
3. Water temperature probe
4. Non return valve
5. Differential pressure switch
10. Vent
11. Drain
13. System load safety pressure switch
14. Pressure gauge
16. Packaged electric pump with high efficiency impeller
17. Pressure relief valve
18. Shut-off valve
19. Filter

T - Temperature probe
PD - Differential pressure switch

TW in Chilled water inlet
TW out Chilled water outlet

⚠ Provide hydraulic shut-off valves outside the unit (option: 'CSVX - Pair of manually operated shut-off valves') to facilitate any extraordinary maintenance operations.

⚠ The head and consumption graphs of the pumping group refer to operation with pure water. If there is a water-glycol mix, please contact Clivet's office to check the correct operating point of the pumping group.

Hydropack electrical data

POMPA	Potenza nominale [kW]	Corrente assorbita nominale [A]
1P1SBV 45.4-60.4	1,5	3,17
1P1SBV 65.4-80.4	2,2	4,56
1P1SBV 85.4	3,0	6,33

Accessories - Hydronic assembly

1P1SBV - User side Hydropack with 1 inverter pump and 1 stand-by pump with dedicated inverter

Head - Size 45.4 - 60.4

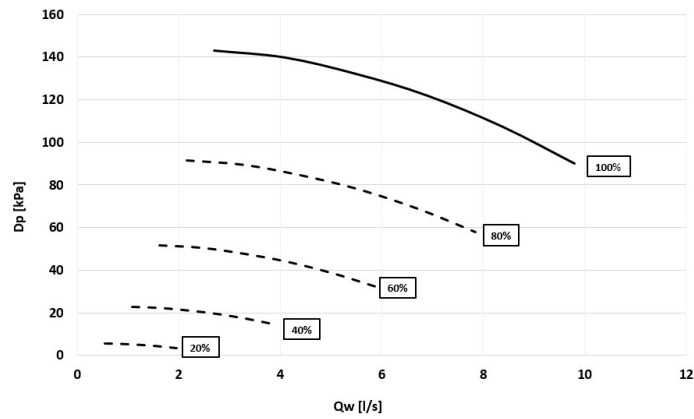

Dp = Pump head [kPa]
QW = Water flow-rate [l/s]

Power input - Size 45.4 - 60.4

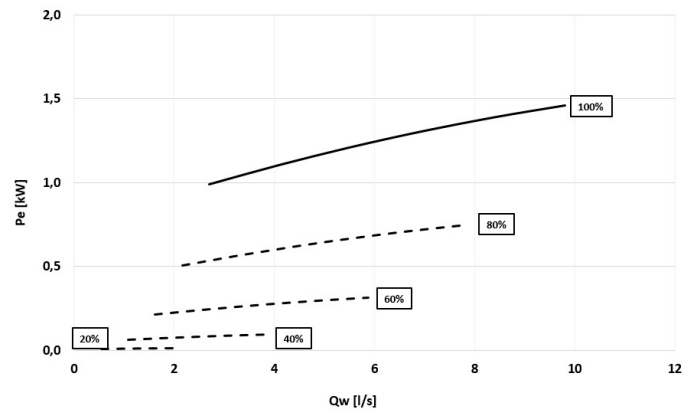

Pe = Power input [kW]
QW = Water flow-rate [l/s]

Head - Size 95.4 - 80.4

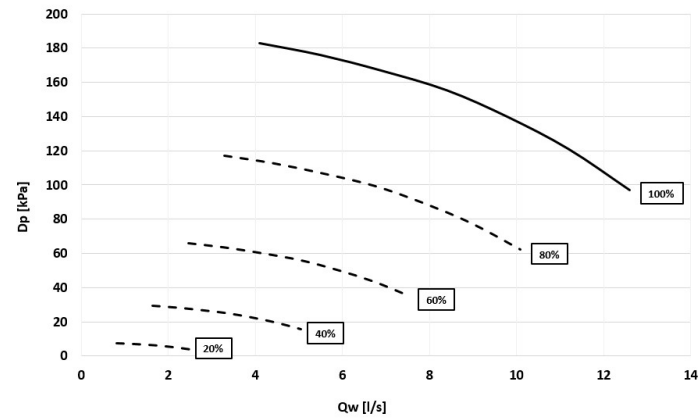

Dp = Pump head [kPa]
QW = Water flow-rate [l/s]

Power input - Size 95.4 - 80.4

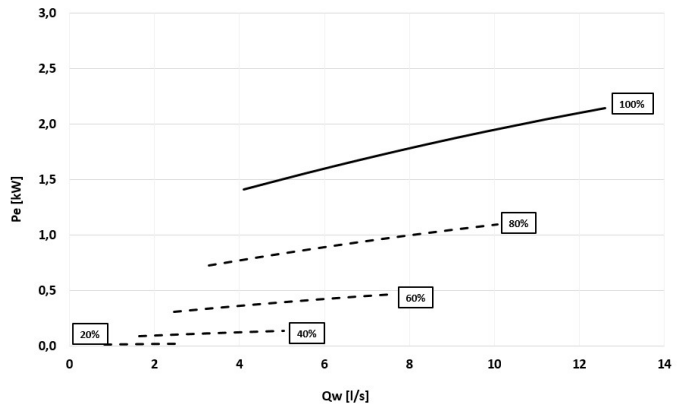

Pe = Power input [kW]
QW = Water flow-rate [l/s]

Head - Size 85.4

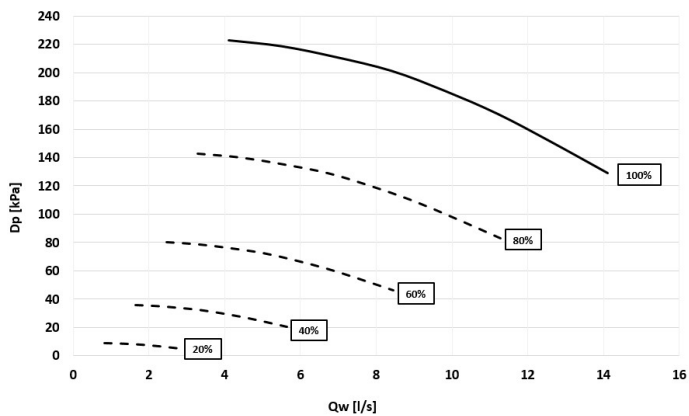

Dp = Pump head [kPa]
QW = Water flow-rate [l/s]

Power input - Size 85.4

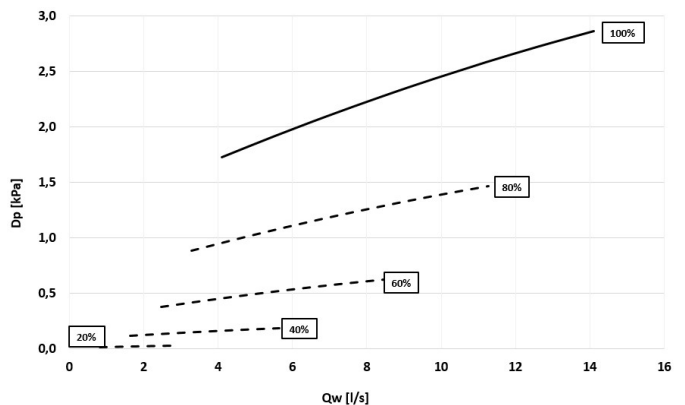

Pe = Power input [kW]
QW = Water flow-rate [l/s]

1PAPSV - User side Hydropack with 1 high head inverter pump and 1 standby pump with dedicated inverter

Pumping group consisting of 1+1 electric pump (1 stand-by) controlled by inverter to adapt to different conditions of use.

Automatically reduces the liquid flow-rate in critical conditions, thereby preventing overloading blockages and the subsequent intervention of specialised technical personnel.

The pump flow-rate/head can be adapted to the system features by calibrating the inverter, which is standard supplied.

Electric centrifugal pump with cast iron pump body and stainless steel or cast iron impeller (depending on the model).

Mechanical seal using ceramic, carbon and EPDM elastomer components.

Three-phase electric motor with IP55 protection rating. Complete with thermoformed insulating casing, quick-release couplings with an insulated casing, safety valve, pressure gauges, system load safety pressure switch, stainless steel immersion antifreeze heaters fitted on the suction and supply lines.

In combination with the “IVFDT” - Variable flow-rate control option, it allows variation of the water flow-rate to the system under partial-load to achieve the highest unit efficiency and lower consumption of the pumping group.

All water fittings are Victaulic.

Option supplied on the unit.

CONNECTION DIAGRAM 1PAPSV - Group with 1 high head inverter pump and 1 standby pump with dedicated inverter

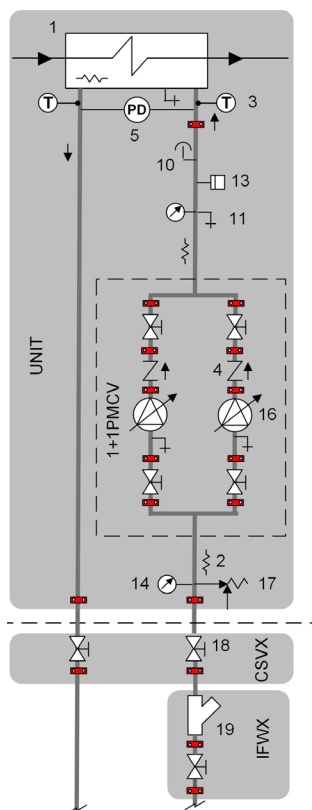

1. Exchanger
2. Antifreeze heater
3. Water temperature probe
4. Non return valve
5. Differential pressure switch
10. Vent
11. Drain
13. System load safety pressure switch
14. Pressure gauge
16. Packaged electric pump with high efficiency impeller
17. Pressure relief valve
18. Shut-off valve
19. Filter

T - Temperature probe
PD - Differential pressure switch

TW in Chilled water inlet
TW out Chilled water outlet

⚠ Provide hydraulic shut-off valves outside the unit (option: 'CSVX - Pair of manually operated shut-off valves') to facilitate any extraordinary maintenance operations.

⚠ The head and consumption graphs of the pumping group refer to operation with pure water. If there is a water-glycol mix, please contact Clivet's office to check the correct operating point of the pumping group.

Hydropack electrical data

POMPA	Potenza nominale [kW]	Corrente assorbita nominale [A]
1PAPSV 45.4-60.4	3,0	6,33
1PAPSV 65.4-85.4	4,0	7,62

Accessories - Hydronic assembly

1PAPSV - User side Hydropack with 1 high head inverter pump and 1 standby pump with dedicated inverter

Head - Size 45.4 - 60.4

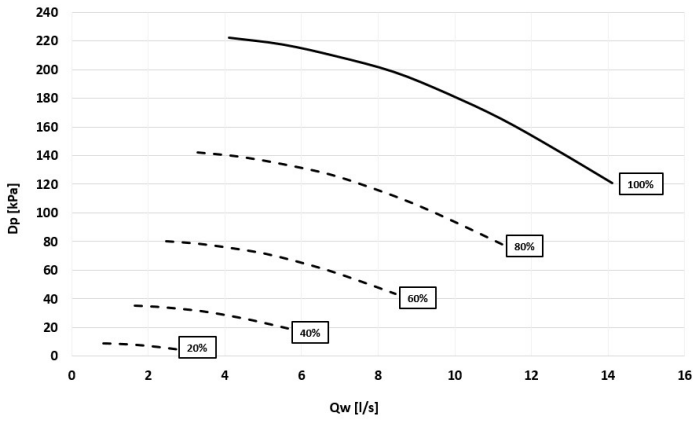

Dp = Pump head [kPa]
QW = Water flow-rate [l/s]

Power input - Size 45.4 - 60.4

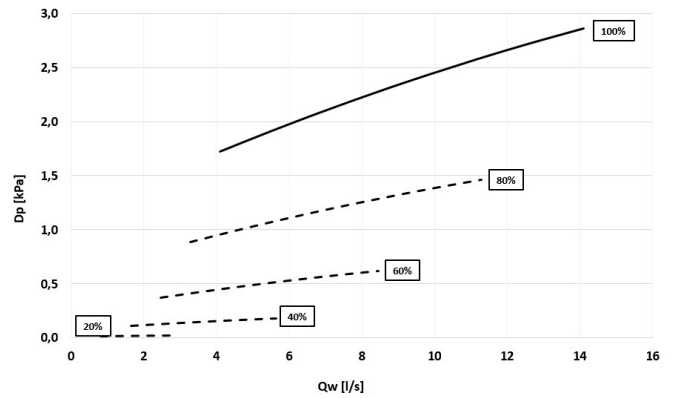

Pe = Power input [kW]
QW = Water flow-rate [l/s]

Head - Size 65.4 - 85.4

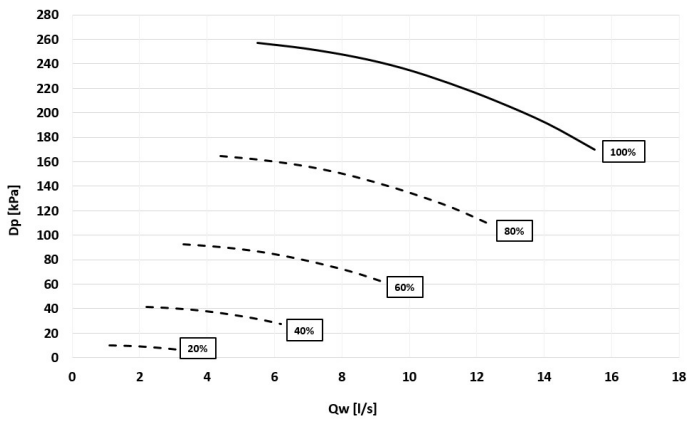

Dp = Pump head [kPa]
QW = Water flow-rate [l/s]

Power input - Size 65.4 - 85.4

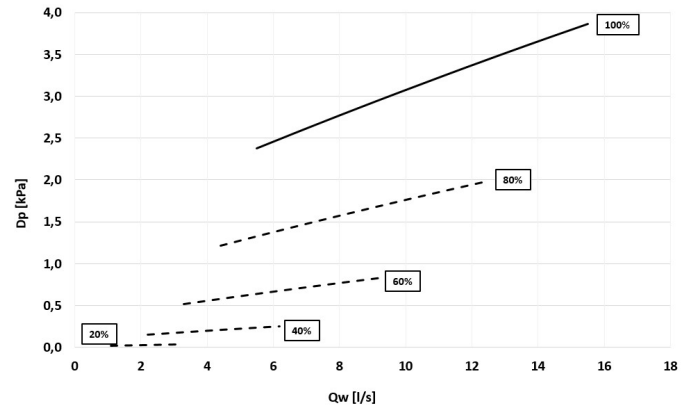

Pe = Power input [kW]
QW = Water flow-rate [l/s]

User interface (HMI)

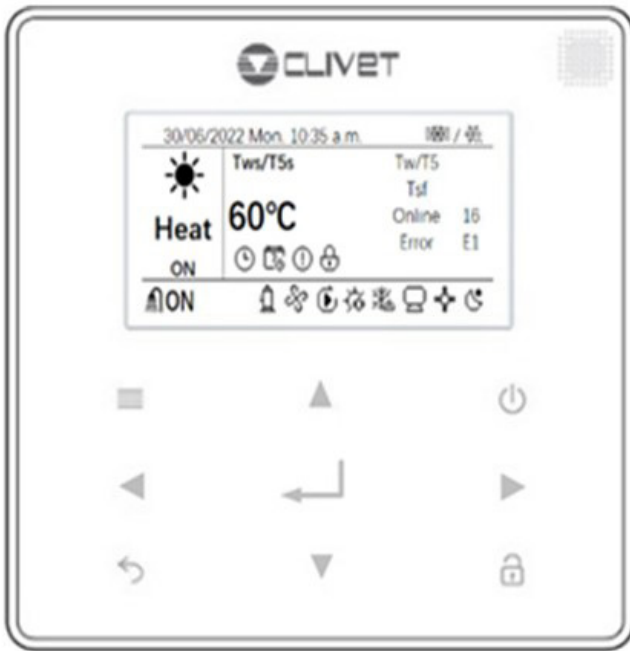

Resolution	1°C	
Temperature sensor	NTC 5k 1%	
Power input	< 1 W	
Storage temperature	-20÷50°C	
Communication	RS485	
Wiring	Type	Shielded cable
	MAX Length	40 m

The unit is equipped with a user interface (HMI) installed on board, to be used for managing the functions and equipped with an integrated temperature probe.

The user interface comes standard with 22 selectable languages: Italian / English / French / Spanish / Polish / Portuguese / German / Dutch / Romanian / Russian / Turkish / Greek / Swedish / Slovenian / Czech / Slovakian / Bulgarian / Serbian / Danish / Ukrainian / Hungarian / Croatian

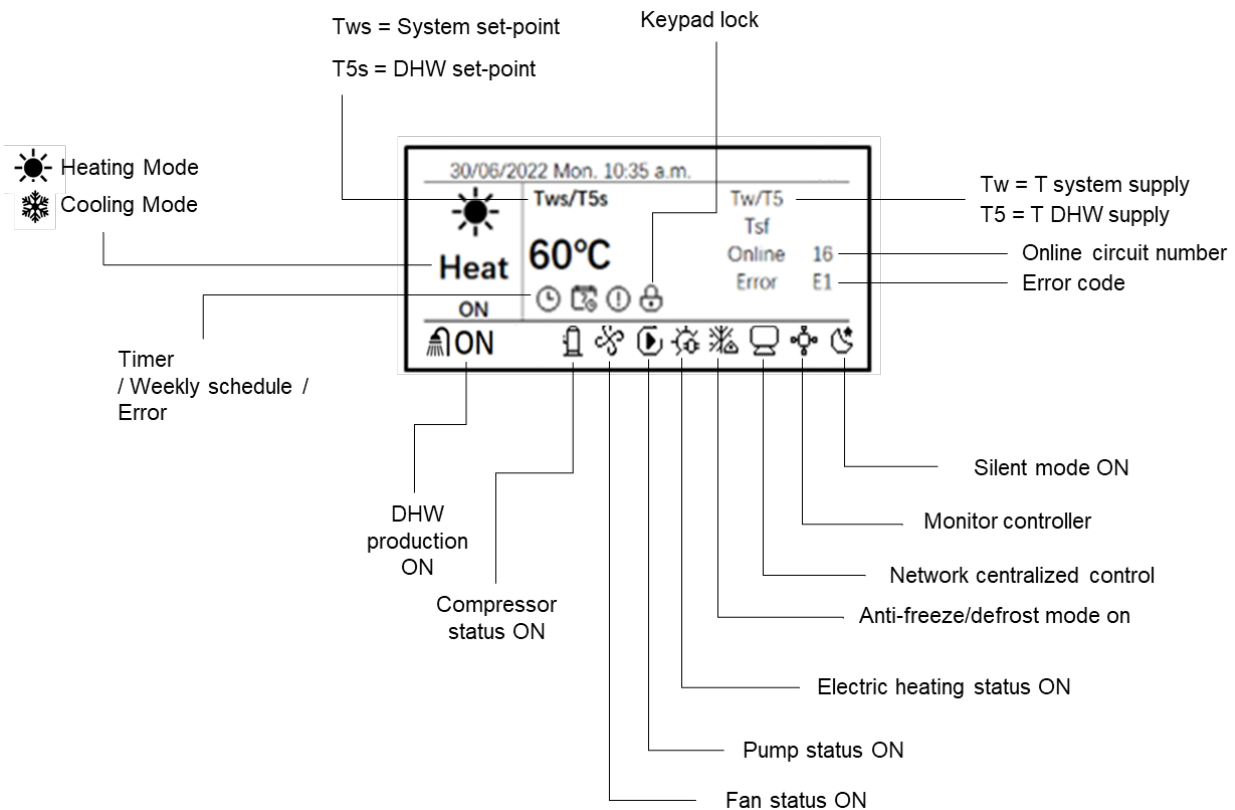

Features and options

DHW management

The following components are required for DHW management:

- SV1: 3-way valve
- Taf1: temperature probe, for DHW antifreeze protection
- T5: Temperature probe, for temperature control and switch between system and DHW

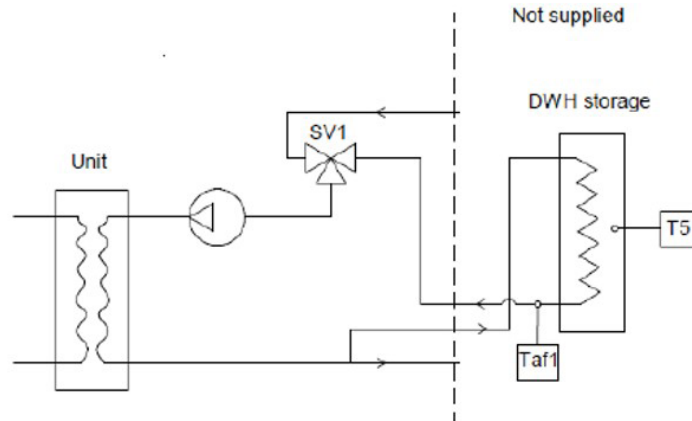

DHW tank connection

As an option, the unit can be connected to a DHW storage tank of suitable volume, by fitting the system with a 3-way diverter valve controlled by the unit. It is advisable to connect the DHW tank at a distance of no more than 10 m from the unit, and preferably as close as possible to the unit. The sizing of the connecting pipes and their thermal insulation must always be considered with care, especially in the case of long distances between the unit and the storage tank.

The standard boiler must have these characteristics:

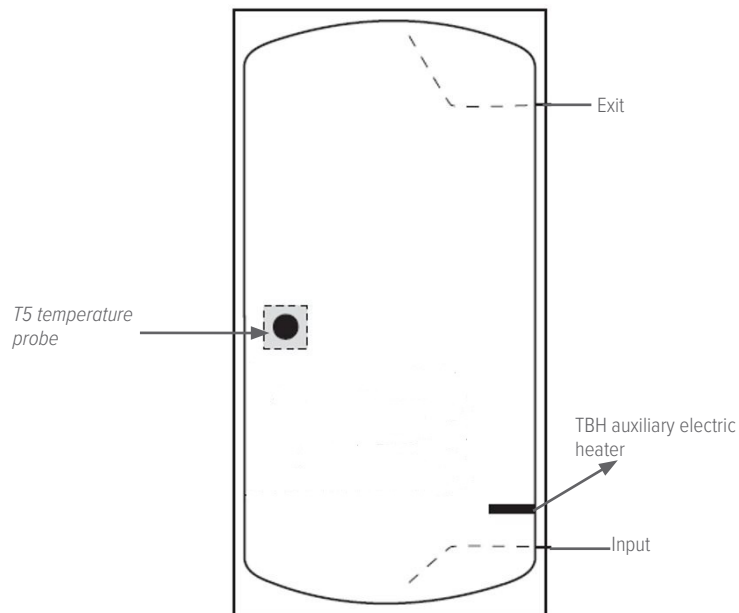

It is recommended to select one with sacrificial anode and integrated auxiliary electric heater, which will be managed by the unit. Make sure that the coil or the intermediate exchanger are suitably sized to ensure correct heat exchange.

Double Set-Point function

It allows to enable the Double setpoint function with HMI. Once enabled, you need to configure the first target water temperature (SetPoint1) and second target water temperature (SetPoint2). At this point the unit detects the closed status of the Double_SP door (normally open). If the contact is open, the unit will operate at the first target water temperature; otherwise, it will operate at the second target temperature.

Set-Point compensation function based on the outside air temperature

Allows to enable the temperature compensation function via HMI. Once the function has been enabled, it is necessary to set:

- The two offset points for the external air temperature (OffsetT4_1 ; OffsetT4_2), which will define the external air temperature field on which the set-point variation will take place;
- The offset point for the water production temperature (OffsetTws) which represents the maximum variation of the set-point allowed. Consequently the unit will update the proportional set-point according to the calculation cycle of the compensation function.

Example of temperature compensation in heating

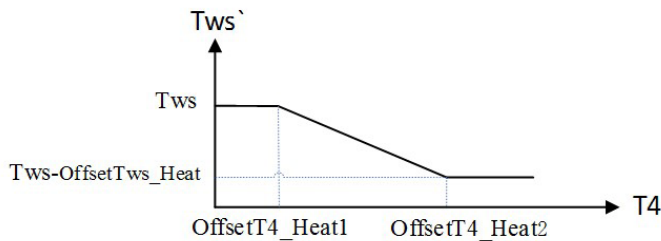

- When the external air temperature (T4) is lower than the offset one ($T4 < \text{OffsetT4_Heat1}$) the set-point remains unchanged
- When the external air temperature (T4) is between the two offset temperatures ($\text{OffsetT4_Heat1} \leq T4 < \text{OffsetT4_Heat2}$), the set-point is reduced in direct proportion to the increase in external air temperature.
- When the outside air temperature (T4) is higher than the highest offset temperature ($T4 \geq \text{OffsetT4_Heat2}$) there will be the maximum reduction in the set-point temperature.

ENEMON function

Through the HMI it is possible to access the display of the main energy parameters of the displayed circuit and in detail:

Power Output = instantaneous power produced in kW

Power Input = instantaneous power absorbed in kW

Current efficiency = instantaneous efficiency represents the EER or the COP

Total energy production is the cumulative energy produced in MWh

The total energy input is the cumulative energy input in MWh

STATE QUERY	
POWER OUTPUT	100 KW
POWER INPUT	50 KW
CURRENT EFFICIENCY	2
TOTAL ENERGY OUTPUT	10 MWh
TOTAL ENERGY INPUT	3 MWh
BACK	2/2 ▲▼◀▶

All energy meter display items are available via Modbus, on addresses from $232 + (\text{Circuit address}) * 100$ a $236 + (\text{Circuit address}) * 100$.

Features and options

SILENT function

The function allows to select up to four acoustic modes, for maximum sound configurability of the units. For three of these modes, Standard, Silent and Supersilent, the heating/cooling capacity, efficiencies and sound levels of all sizes are shown in the general technical data section of the bulletin, as well as on the navigator.

The Night Mode configuration, on the other hand, allows for a further reduction in the sound level of up to 3 dB(A) compared to the supersilent mode, for an even lower acoustic impact of the unit. To select the mode of interest, simply set it from the HMI through the User menu as shown in the following screen.

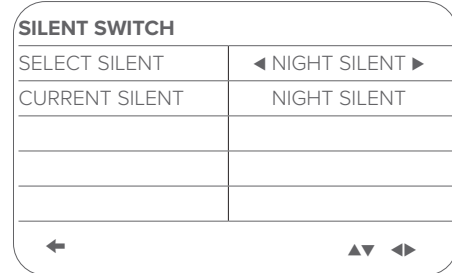
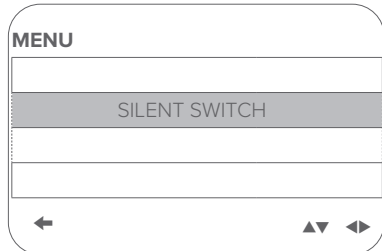

Smart Grid & EVU functions (REMAU option required)

The unit is certified Smart Grid Ready and is equipped with logic for connection to devices that balance the loads connected to the electric grid and optimize general electricity consumption. The connection is optional, the function can be enabled from the REMAU and is linked to the ON/OFF SG input, which receives a status signal from the electrical network.

The unit is also set up to store free thermal energy in the DHW tank. The function is activated by the REMAU enabling the Smart Grid function and is linked to the ON/OFF EVU input, which receives a signal from the energy meter which indicates to the unit when free energy overproduction is available.

The regulation logic of the two contacts is:

CONTACT		OPERATION	
SG	EVU	SYSTEM	DHW
ON	ON	DHW forced	Forced DHW operation with set point T5S = 60°C Once the DHW set-point is reached, the Heat Pump returns to work on the system
OFF	ON	OFF forced	OFF forced
OFF	OFF	Standard	Standard
ON	OFF	Standard	Standard

Modularity

Many applications require drives to be installed as back-up to the main system or have loads that can change significantly during annual operation.

Through this function, without the aid of further accessories, it is possible to operate with up to 8 units hydraulically connected in parallel. From the user interface of the unit defined as Master, the other units are electrically connected in series through the dedicated terminals P, Q and E. Each connected module is identified by an address, from 0 to 15: the Master unit is identified as 0. Complete control of the system (including ancillary elements such as external pumping system and auxiliary heater) is handled by the Master unit.

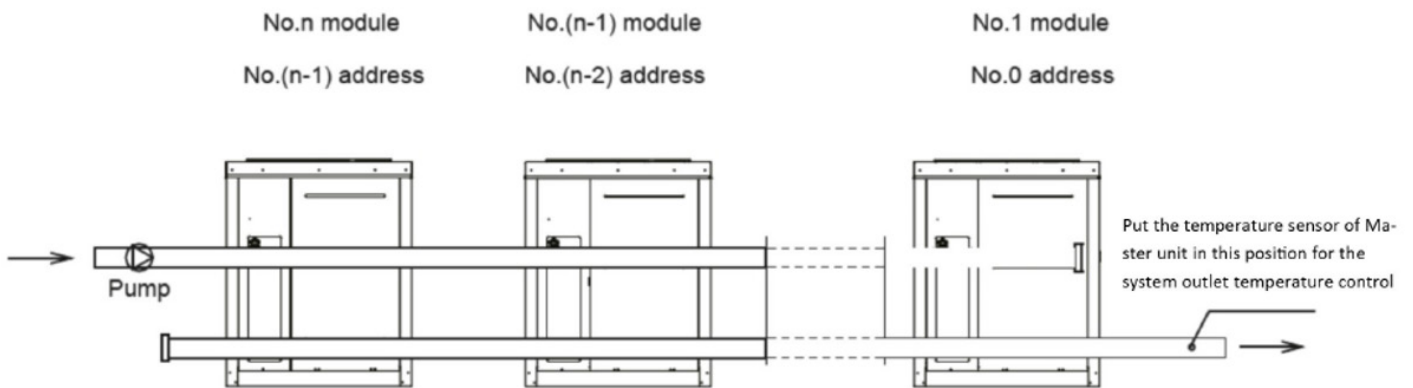

Operation

The Master unit calculates the required heating/cooling capacity of the system based on the water delivery temperature and the temperature set-point. Instead, each individual unit calculates its required heating/cooling capacity based on the delivery and return temperatures. The activation of the units takes place according to the last in first out logic (the last unit to be activated will also be the first to be deactivated) and is indicated in the following two figures.

- T_w = Water supply temperature
- T_{ws} = Water supply temperature set-point

Cooling mode

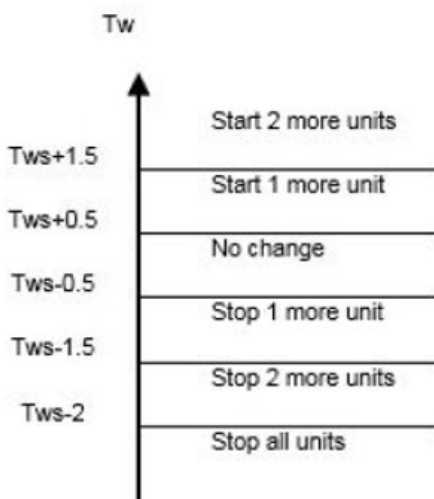

Heating mode

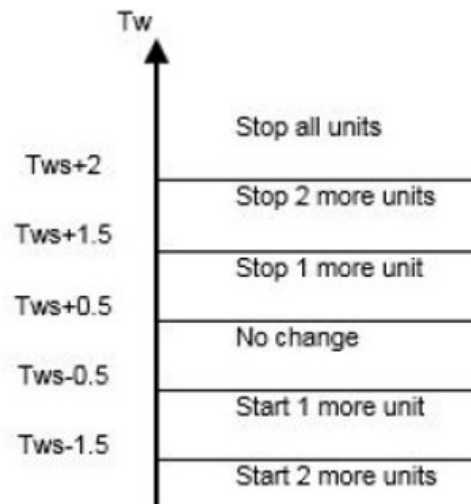

In cooling mode, if $T_w \geq T_{ws} - 10^\circ\text{C}$ 50% of the system units are activated.

In heating mode, if $T_w \leq T_{ws} - 10^\circ\text{C}$ 50% of the system units are activated.

After having satisfied the system load and having deactivated the units, at the next start-up the first unit to have been deactivated will be the first to be started, in order to guarantee the correct balancing of the operating hours.

Modularity and management of cascade units

DHW (Domestic Hot Water) settings and management

The unit is designed to be coupled to boilers for DHW storage (enabled by HMI), connected with a special T5 probe. To switch from system operation to DHW production, the system will first be stopped and then switch to DHW. There are two conditions verified before starting DHW production:

CONDITION 1 that the temperature T5 detected by the DHW storage is higher than the minimum value for starting DHW production, and lower than the minimum value between the DHW storage set-point temperature and the maximum temperature that the unit is able to guarantee at a given external temperature, net of the temperature delta for DHW production input equal to the default 8°C

CONDITION 2 that the unit outlet temperature is lower than the minimum value between the DHW storage set-point temperature and the maximum supply temperature that the unit is able to guarantee at a given outside temperature, net of 2°C by default.

DHW production is stopped if:

- Domestic hot water mode is stopped via HMI
- The detected temperature T5 is higher than the minimum value between between the DHW storage set-point temperature and the maximum temperature that the unit is able to guarantee at a given external temperature
- The detected temperature T5 is lower than the minimum value for starting DHW production
- The temperature output from the unit is greater than the minimum value between the maximum supply temperature that the unit is able to guarantee at a given outside temperature and the unit target set-point increased by 2°C

Installation with multiple pumps on the system

In the system with multiple pumps, both master and slave units must be configured separately for DHW operation, and consequently it will be necessary to set DHW production as priority. DHW priority is configurable from the following menu screen:

- Priority DHW production**
Once the DHW priority has been set, if the unit is in stand-by, CONDITION 1 is evaluated as in the case of a system with a single pump, and if this is verified, the production of domestic hot water is started, if otherwise, the unit is started to satisfy the system load.
If CONDITION 1 is verified when the unit has exceeded the minimum system side operating period, DHW production is started, otherwise the activation of the auxiliary heater TBH is evaluated and DHW production passes to the booster pump. heat only after the minimum period of operation on the system side and CONDITION 1 are satisfied.
- Non priority DHW production**
If the DHW priority has not been set, the unit is started directly to satisfy the system load, and CONDITION 1 is evaluated only after the minimum system side operating time has elapsed. If this is satisfied, it is started DHW production, otherwise the activation of the auxiliary heater TBH is evaluated and DHW production passes to the heat pump only after CONDITION 1 is satisfied.

DHW SWITCH

SELECT ADDRESS	◀ 11 ▶
DHW SWITCH	◀ SI ▶
PRIORITY	◀ SI ▶
07 06 05 04 03 02 01 00	
15 14 13 12 11 10 09 08	
◀ ◀▶ ▶▶ ▶	

In DHW production mode, the compressors start only if the DHW tank temperature is above a minimum threshold (see table). To avoid the temperature falling below the minimum threshold, it is recommended to install an electric backup heater on the DHW storage tank.

T outdoor	T5	compr.	backup heater
24°C < t.o ≤ 30°C	< 15°C	OFF	ON
24°C < t.o ≤ 30°C	≥ 15°C	ON	OFF
t.o > 30°C	< 20°C	OFF	ON
t.o > 30°C	≥ 20°C	ON	OFF

The maximum system supply for T5S (DHW set-point) is lower than the maximum set point that can be reached by the unit to consider heat exchange. num value that can be set

Applications may require different management mode. Through the modular system it is possible to configure the system in different modes, here below some example:

- A. Configuration with independent operation: in this configuration it is necessary to have a DHW tank for each unit and a DHW three-way valve for each unit. The operation of each unit is independent from the others, each unit manages its own DHW production request.

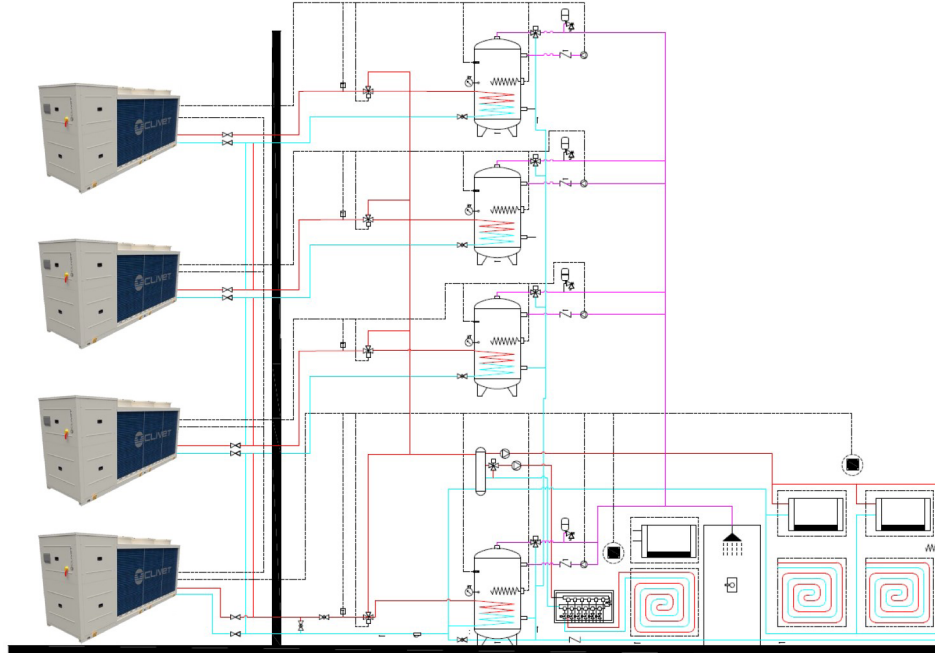

Management of auxiliary heat sources

The optimal configuration solution of the auxiliary heat source involves the positioning of the electric heater in derivation on a DHW tank and the positioning of the boiler on the system.

The electric heater must be positioned into the DHW tank and its operation is linked to a dedicated T5 able to detect the DHW tank temperature

The boiler must be installed in parallel with the heat pump and acts on the system: it is installed on a hydraulic separator, where the TW probe must also be positioned.

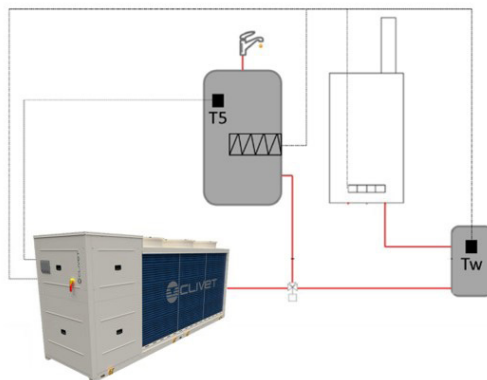

The setting must be completed during installation, by selecting the boiler operating mode using the unit keyboard.

The auxiliary heater source can perform the function of integration to the heat pump. To activate the functions of the heat pump integration heater, make sure that Dip-Switch S6-1 is in the ON position (upwards) and you must have activated Heat1 from the HMI; as regards the other parameters, they must be configured according to your needs once you understand their function which is described below.

Within 2 minutes of switching on the pump, the auxiliary heater control is kept OFF and the following cases may arise:

- A. Operation of the auxiliary heater in place of the heat pump: When the heat pump cannot operate due to a fault or is in protection mode (compressors not limited): in this case the auxiliary heater intervenes in place of the heat pump when the water temperature is less than 3K compared to the set point and switches off once the water temperature has exceeded the set point by 2K (adjustable value from the HMI).
- B. Heat 1 activation forcing: In this mode, manual operation of the auxiliary heater will be started. Once the set point is reached the auxiliary heater will switch off. The manual command is valid only once therefore even if the water temperature drops below the setpoint it will not start automatically and will need a new manual command to start.
- C. Operation of the auxiliary heater at low air temperature: In case the unit is operating in heat pump mode with an air temperature lower than 5°C (Value adjustable from the HMI) but does not reach the set point within 90 min (value adjustable from the HMI), then the auxiliary heater integrates with the heat pump.
- D. Activation of the auxiliary heater in integration with the heat pump: If the set point is higher than the maximum set point of the unit envelope, then the auxiliary heater is activated in integration with the heat pump.

Title	Effect	Predetermined Area	Default
Heat1 Enable	Riscaldatore ausiliario impianto	No/Yes	No
T_Heat1_Delay	Tempo di attivazione	60.....240 min	90 min
DT_Heat1_OFF	ΔT off rispetto al set point	2.....10°C	5°C
T4_Heat1_ON	Temperatura dell'aria sotto la quale interviene Heat1	-5.....13°C	5°C

A further HEAT2 function is also available, useful for controlling the auxiliary heater for DHW storage. This function must also be enabled from the HMI and requires the installation of a T5 probe which makes possible the DHW auxiliary heater management very similar to the ones already explained previously. Only one differs substantially and is the intervention of the auxiliary generator during the disinfection process of the domestic hot water storage, which takes place as described below:

Intervention of the auxiliary heater in the DHW storage disinfection process. Once the function has been enabled from the HMI, this sends the disinfection cycle request:

If the unit is in stand-by/cooling or heating mode, it enters DHW mode and starts the disinfection cycle;

If the unit is performing a defrost cycle, the cycle is completed first and then the disinfection function is activated.

In this process, the permanence of the DHW storage tank temperature T5 above 69°C is evaluated. whenever the temperature drops below 69°C.

At the beginning of the disinfection cycle, on the other hand, a second Timer2 time count starts.

Based on the two time parameters above, the disinfection cycle ends if the domestic hot water storage tank has maintained a temperature equal to or higher than 69°C for at least twenty minutes, or if the disinfection cycle has lasted at least 60 minutes

The unit therefore allows the hybrid version solution in combination with a third-party generator, thanks to the control of the auxiliary generator via the HEAT1/HEAT2 contacts as previously reported.

Some simplified functional diagrams are shown below with different combinations of unit and boiler: these diagrams are proposed by way of example.

In a multi-zone configuration with one or more heat pump units in cascade, and a single gas boiler, the auxiliary heat generator will be activated when the heat pump or the heat pump cascade system is not sufficient to satisfy the demand of the 'plant.

Single heat pump and single gas boiler

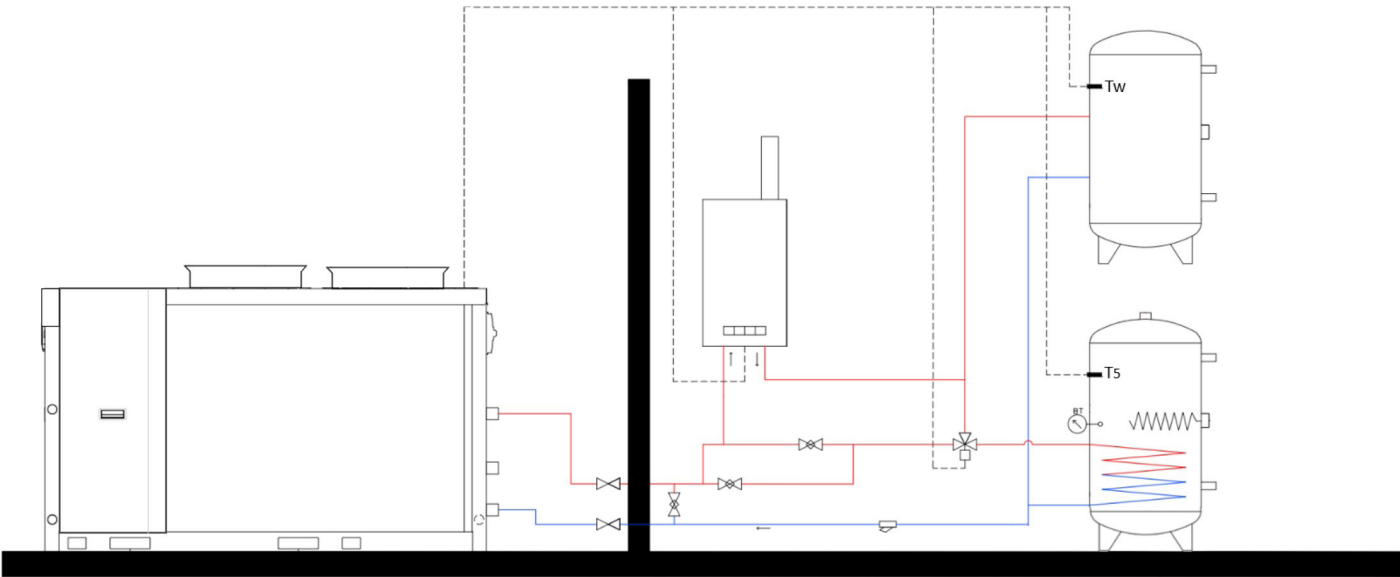

System with cascade heat pumps and single gas boiler

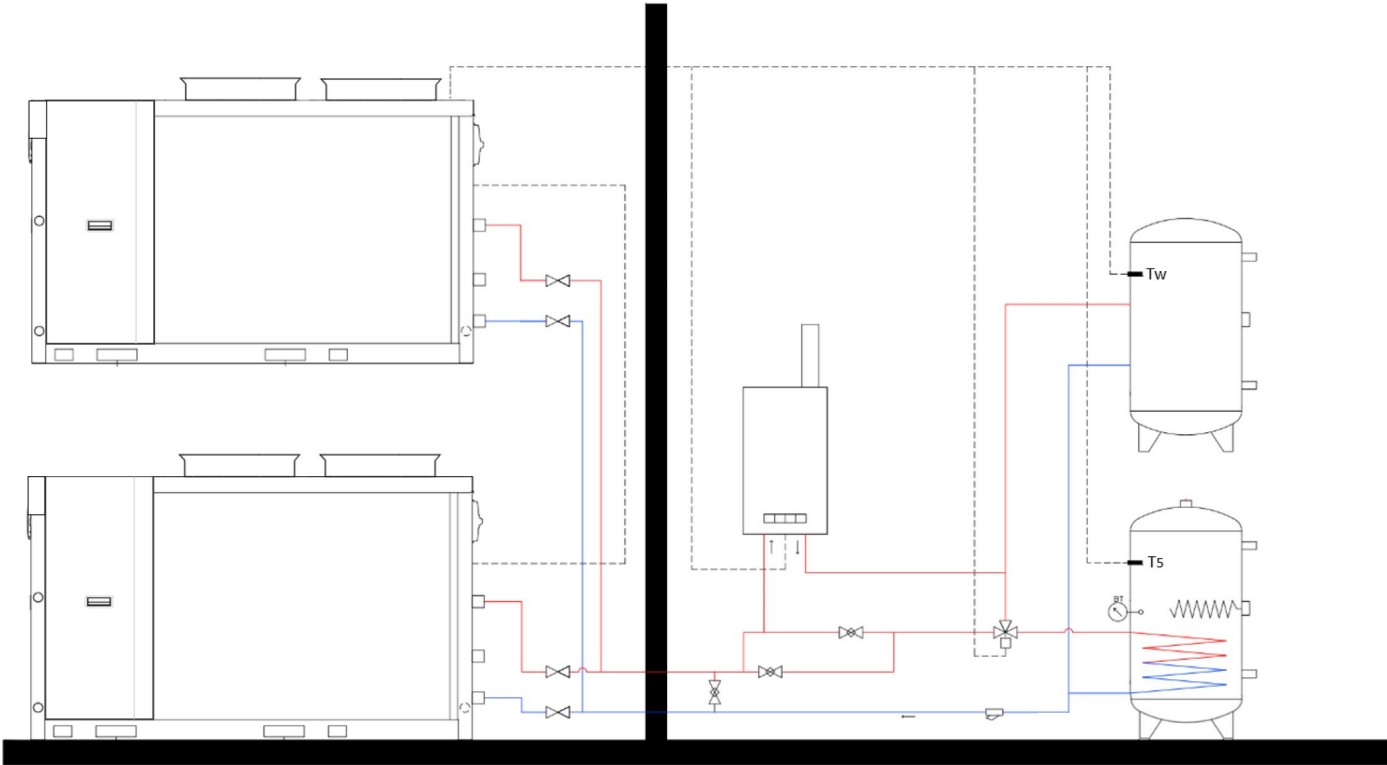

In a multi-zone configuration with one or more heat pump units in cascade, and Gas Boiler system in cascade, the auxiliary heat generator is activated when the heat pump or the heat pump cascade system in cascade is not sufficient to satisfy the plant request. When even the first auxiliary heat generator is not sufficient to satisfy the request, the second generator will also be activated for integration.

Management mode

Single heat pump and cascade gas boiler

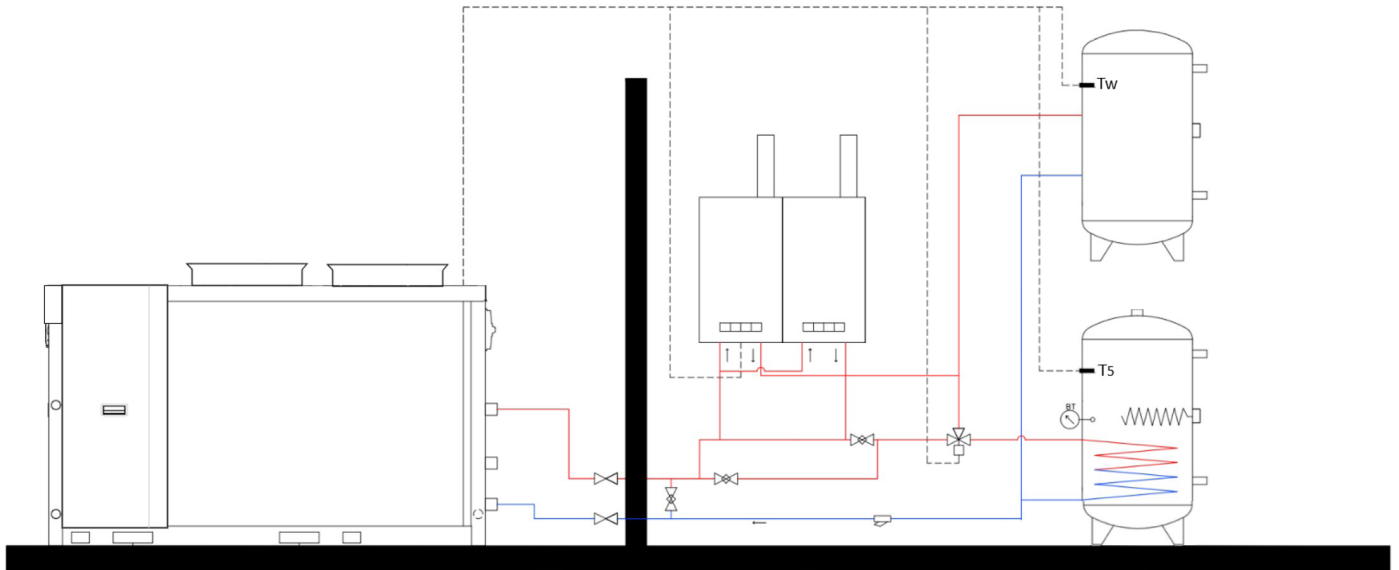

System with cascade heat pumps and cascade gas boiler

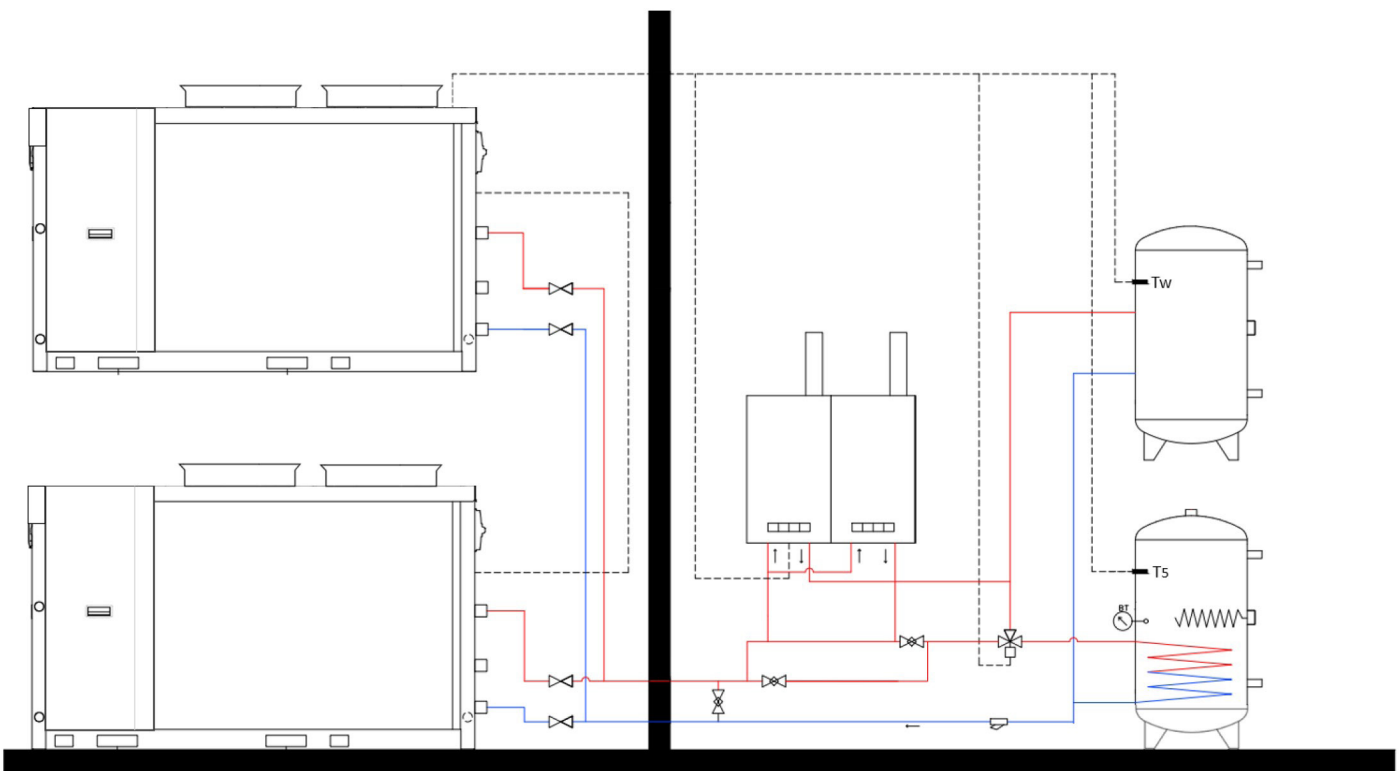

SIZE 45.4 ÷ 60.4

DAAI40001_00
DATA/DATE 06/10/2022

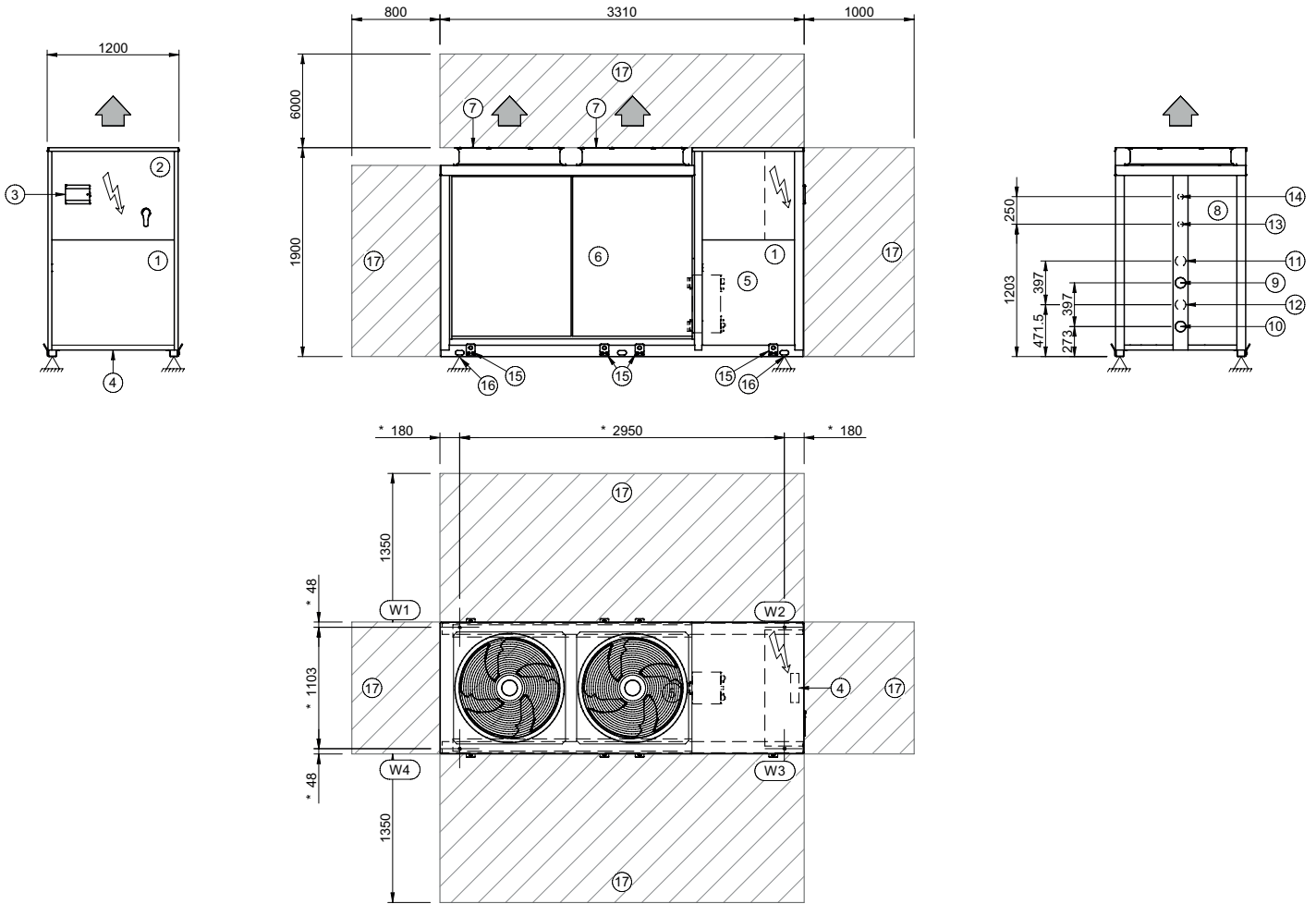

1. Compressor compartment
2. Electrical panel
3. Human Machine Interface
4. Power input
5. Internal exchanger
6. External exchanger
7. Fan
8. Rear compartment
9. Victaulic 2" 1/2 water inlet connection
10. Victaulic 2" 1/2 water outlet connection

11. Victaulic 2" 1/2 DHW water inlet connection
 12. Victaulic 2" 1/2 DHW water outlet connection
 13. Victaulic 1" 1/4 gas partial inlet recovery water connection
 14. Victaulic 1" 1/4 gas partial outlet recovery water connection
 15. Lifting bracket (removed)
 16. Support points
 17. Functional clearances
- * Position of antivibration mounts

SIZE		45.4	50.4	55.4	60.4
Length	mm	3310	3310	3310	3310
Depth	mm	1200	1200	1200	1200
Height	mm	1900	1900	1900	1900
W1 Support point	kg	171	171	168	168
W2 Support point	kg	312	312	323	323
W3 Support point	kg	312	312	341	341
W4 Support point	kg	171	171	177	177
Operation weight	kg	966	966	1009	1009
Shipping weight	kg	952	952	994	994

Dimensional drawings

SIZE 65.4 ÷ 85.4

DAAI40002_00
DATA/DATE 06/10/2022

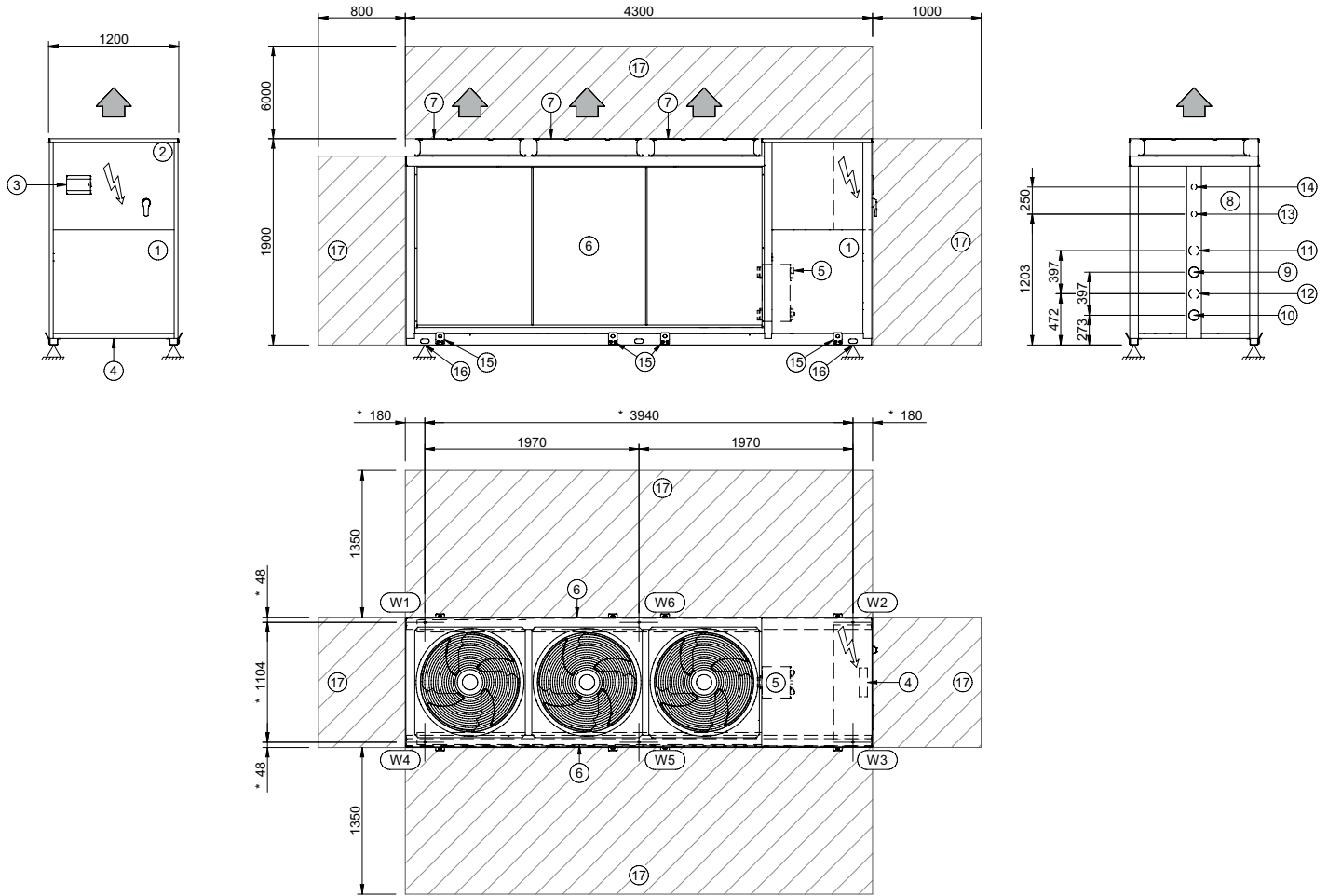

1. Compressor compartment
2. Electrical panel
3. Human Machine Interface
4. Power input
5. Internal exchanger
6. External exchanger
7. Fan
8. Rear compartment
9. Victaulic 2" 1/2 water inlet connection
10. Victaulic 2" 1/2 water outlet connection

11. Victaulic 2" 1/2 DHW water inlet connection
 12. Victaulic 2" 1/2 DHW water outlet connection
 13. Victaulic 1" 1/4 gas partial inlet recovery water connection
 14. Victaulic 1" 1/4 gas partial outlet recovery water connection
 15. Lifting bracket (removed)
 16. Support points
 17. Functional clearances
- * Position of antivibration mounts

SIZE		65.4	70.4	75.4	80.4	85.4
Length	mm	4300	4300	4300	4300	4300
Depth	mm	1200	1200	1200	1200	1200
Height	mm	1900	1900	1900	1900	1900
W1 Support point	kg	210	210	234	234	234
W2 Support point	kg	415	415	442	442	442
W3 Support point	kg	415	415	442	442	442
W4 Support point	kg	210	210	234	234	234
Operation weight	kg	1250	1250	1352	1352	1352
Shipping weight	kg	1231	1231	1334	1334	1334

Page intentionally left blank

Page intentionally left blank

FOR OVER 30 YEARS WE HAVE BEEN OFFERING SOLUTIONS TO ENSURE SUSTAINABLE COMFORT AND THE WELL-BEING OF PEOPLE AND THE ENVIRONMENT

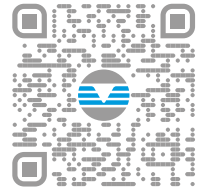

sales and service

www.clivet.com

MideaGroup
humanizing technology

Inizio validità: 2023 - (revisione 06/2024)
BT23B017GB-07



CLIVET S.p.A.

Via Camp Lonc 25, Z.I. Villapaiera 32032 - Feltre (BL) - Italy
Tel. +39 0439 3131 - info@clivet.it

CLIVET GMBH

Hummelsbütteler Steindamm 84,
22851 Norderstedt, Germany
Tel. +49 40 325957-0 - info.de@clivet.com

Clivet Group UK LTD

Units F5 & F6 Railway Triangle,
Portsmouth, Hampshire PO6 1TG
Tel. +44 02392 381235 -
Enquiries@Clivetgroup.co.uk

CLIVET LLC

Office 508-511, Elektrozavodskaya st. 24,
Moscow, Russian Federation, 107023
Tel. +7495 6462009 - info.ru@clivet.com

CLIVET MIDEAST FZCO

Dubai Silicon Oasis (DSO) Headquarter Building,
Office EG-05, P.O Box-342009, Dubai, UAE
Tel. +9714 3208499 - info@clivet.ae

Clivet South East Europe d.o.o.

Jarušćica 9b
10000, Zagreb, Croatia
Tel. +3851 222 8784 - info.see@clivet.com

CLIVET France SAS

6 Allée Kepler,
77420 Champs-sur-Marne
France
mail: info.fr@clivet.com
Tel: +33 1 88 60 99 40

Clivet Airconditioning Systems Pvt Ltd

Office No.501 & 502,5th Floor, Commercial -I,
Kohinoor City, Old Premier Compound, Off LBS
Marg, Kirool Road, Kurla West, Mumbai
Maharashtra 400070, India
Tel. +91 22 30930200 - sales.india@clivet.com