



*Packaged high efficiency  
direct expansion Rooftop air  
conditioner.*

# CLIVETPack<sup>3</sup>

CSRN-Y 60.4-120.4 RANGE



TECHNICAL BULLETIN



SIZE	60.4	70.4	80.4	90.4	100.4	120.4
COOLING CAPACITY KW	208	232	261	294	322	374
HEATING CAPACITY KW	200	222	252	286	311	367

## Pagina

3	Features
5	Configurations
8	Unit configuration
12	Standard unit technical features
14	General technical data
22	Option compatibility
24	Standard functions
25	Accessories
40	Accessories separately supplied
45	Performance
51	Dimensional drawings



Clivet partecipa al Programma di Certificazione Eurovent per "Rooftop".  
I prodotti interessati figurano sul sito [www.eurovent-certification.com](http://www.eurovent-certification.com)

# Features

## CLIVETPack<sup>3</sup> for medium attendance applications

The CSRN-Y units are high-efficiency stand-alone air conditioners designed for medium and large commercial areas with air renewal. They are specifically designed for medium crowded environments such as: shopping centers, shopping galleries, supermarkets, hypermarkets, railway stations, airports and industrial warehouses. The series features a double refrigeration circuit with scroll compressors connected in Tandem on each individual circuit. This solution makes it possible to follow the trend of the thermal load even in mid-seasons, reaching very high seasonal performance and by far exceeding the minimum requirements set by the ErP 2021 regulations.

## Clivet Rooftop are Eurovent certified products (within program scope)

The ClivetPack3 series has the Eurovent Certified Performance quality mark, which means it has been tested strictly in accordance with the European standards. This provides an additional guarantee for the customer: performances are certified and permit accurate analysis of the running costs "Total Life Cycle Cost".

Thanks to the single-block design of the unit, all of the plant engineering parts are contained inside the unit, already assembled and tested.

Four configurations available, from the full recirculation version, with minimum fresh air, to versions with renewal and energy recovery on the exhaust air. Each one can be integrated with a broad range of accessories that customise the product according to the application

- ✓ Double refrigeration circuit with two scroll compressors connected in parallel that allow for up to 3 partialisation steps per circuit.
- ✓ Radial fans directly coupled to EC brushless motors (plug fans) allow to adjust the airflow according to the characteristics of the aerodynamic system. On both the supply and the exhaust section.
- ✓ Filtration of air in several stages, from the efficiency class G4 to classes of absolute filtration (electronic filters with iFD technology).
- ✓ UV-C lamps with active germicidal action against fungal spores, bacteria and viruses, for maximum air quality, effective against SARS-CoV-2.
- ✓ Innovative and patented REVO thermodynamic recovery.
- ✓ Energy recovery via enthalpy wheel available for CBK-G version
- ✓ Constant or variable control of the flow of supply air.
- ✓ Automatic and variable control of the amount of fresh air based on the actual occupants requirement, with air quality probe.
- ✓ Freecooling function when it is possible to use outdoor air directly to meet the internal loads.
- ✓ Great air distribution flexibility, with the option of connecting a roofcurb for supply and/or return from below.
- ✓ Summer dehumidification function with hot-gas post-heating to increase comfort even with high latent loads.
- ✓ Heating solutions that can be used together with or instead of the heat pump: electric heaters, hot water coil, modulating gas module with condensation technology.
- ✓ Humidification systems integrated in the unit.
- ✓ Possibility of connection to the main supervision systems with Modbus communication protocol supplied as standard.

All the accessories are cabled and supplied on board the unit unless specified otherwise.

## Clivet's choice towards a green evolution

### New R32 refrigerant

European regulation EC 517/2014 envisages a reduction in the use of HFC (F-gas) refrigerants with the aim of reducing their environmental impact, measured through the GWP (Global Warming Potential) parameter.

Clivet, which has always placed a strong focus on the development of technological solutions aimed at protecting the environment, introduces R32 refrigerant with a low GWP (675) on Rooftop units as well.

The environmental impact is thereby reduced by up to 80% not only thanks to the low GWP of R32, but also thanks to the reduction and optimisation of the refrigerant charge ensured through the careful design of each individual component.

The use of this A2L refrigerant (mildly flammable) is in line with the EN 378 standard, which defines its correct application based on the refrigerant charge and the surface of the rooms serviced.

Limit line calculated with room height equal to 6m

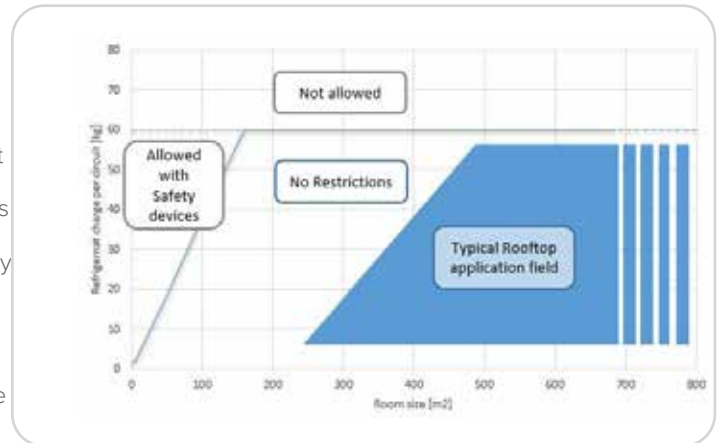

# Configurations

## CAK - Configuration with single fan section for full recirculation

For air conditioning applications only, without the need for fresh air renewal. The supply fan section provides the required static supply and return head.

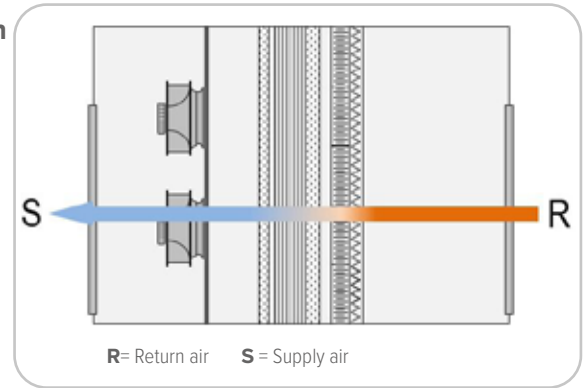

## CBK - Configuration with single fan section for recirculation and fresh air

For applications where there is the need to keep the room in over-pressure, with the option of controlling a particular fresh air flow. As for the CAK configuration, the supply fan section provides the supply and return available static pressure

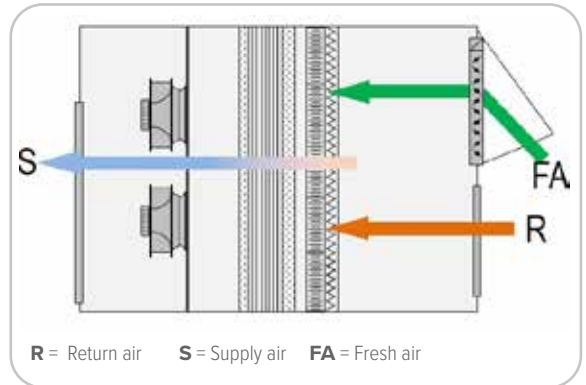

## CBK-G - Configuration with single fan section for recirculation, renewal and exhaust

It ensures the renewal of ambient air and the simultaneous exhaust of stale air through a dedicated section. In addition to the configuration with modulating renewal damper and return from below (R3), the unit is fitted with a modulating recirculation damper and a gravity exhaust damper. The control logic automatically manages the renewal and exhaust of air directly on board the unit, activating Freecooling when possible up to 100% in proportion to the load to be fulfilled. The solution with gravity damper ensures the correct operation of the unit for installations with pressure drops on the return channel up to 50 Pa and is compatible only with the return section in position R3 (from the bottom). The following accessories are available for configuration CBK-G:

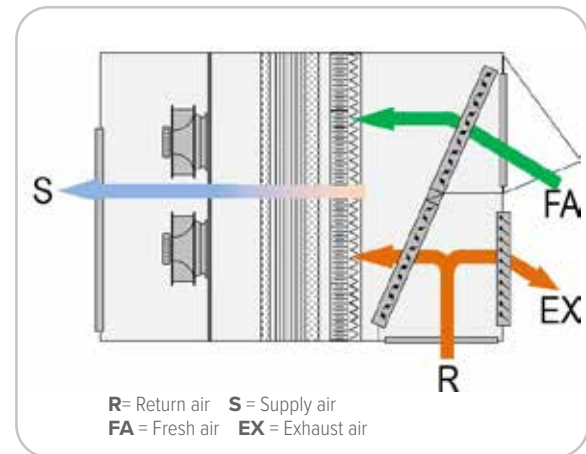

## NSERG - Gravity exhaust air damper not required

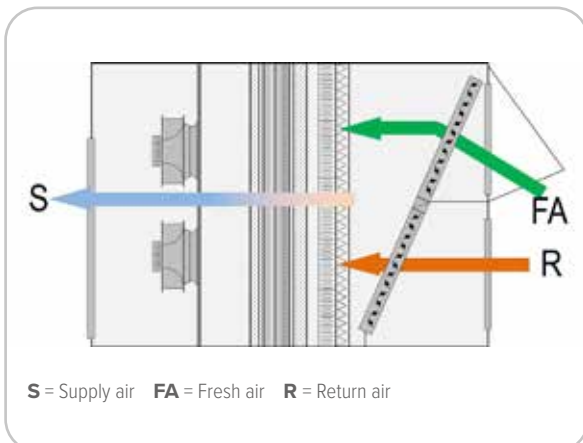

## EWX - Enthalpy Wheel Energy Recovery Module

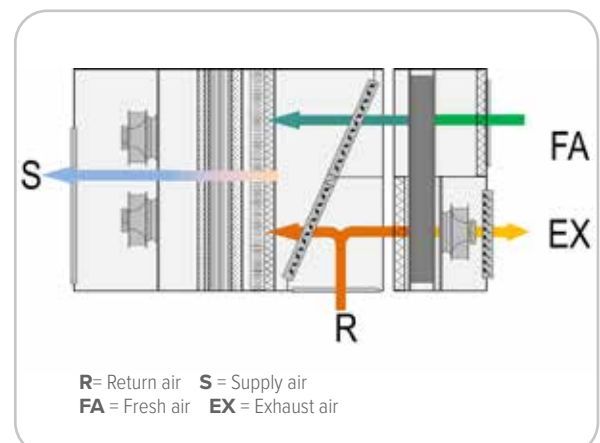

## CCK-REVO - Dual ventilating section with renewal air and REVO thermodynamic recovery

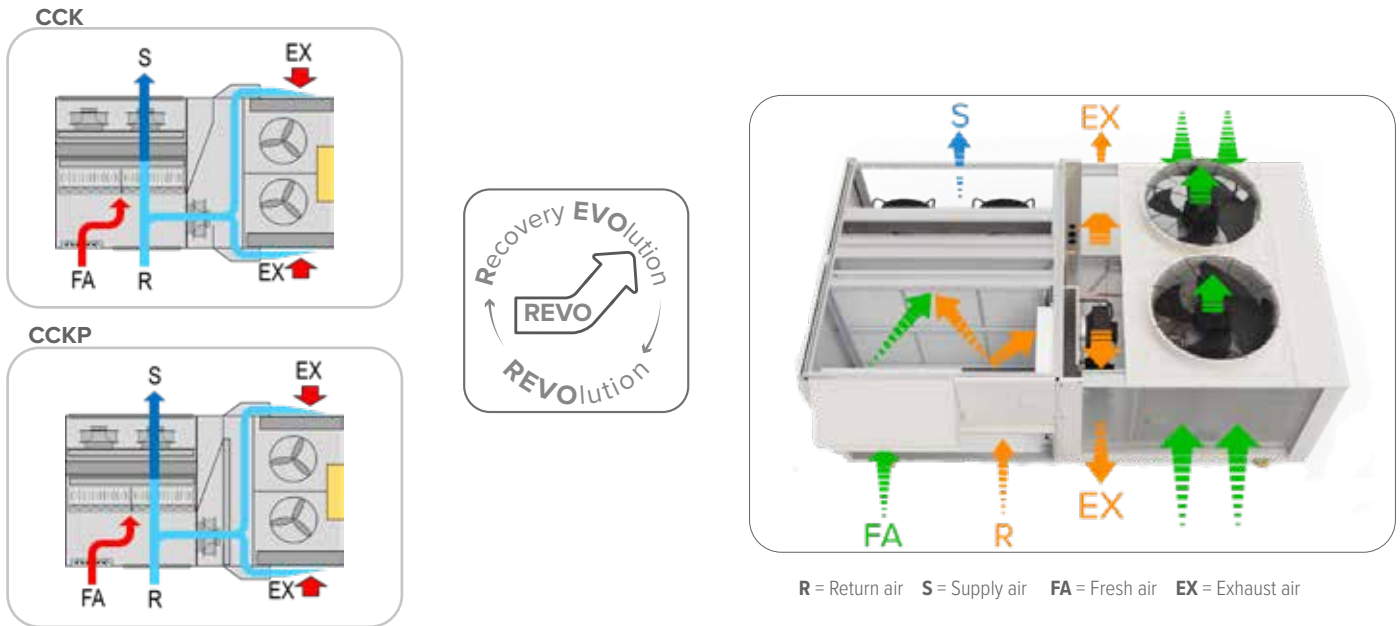

A new concept of thermodynamic recovery is introduced, which combines in a single version the benefits and performance of the previous CCK and CCKP configurations.

For applications with automatic air renewal and FREE-COOLING function control.

The unit is fitted with an exhaust section featuring an innovative and patented REVO thermodynamic recovery for exhaust air (Recovery EVOLution).

The innovative REVO recovery is always included in the CCK-REVO configuration and uses the technology of the refrigeration circuit with direct expansion.

The energy contained in the flow of exhaust air is recovered in a dedicated sector of the direct expansion source coil.

The amount of energy recovered can be easily measured, as in the case of static heat recovery.

Here below are the main benefits of energy recovery:

- Increased power delivered to the conditioned room.
- Increased overall efficiency of the unit for significant energy savings and guaranteed investment payback.
- Unit length reduced by 5%, ensuring a compact design and easy positioning.
- Refrigerant charge reduced by 50% compared to CCKP version, for a lower environmental impact of the unit and greater safety for users.
- Optimised industrialisation and reliability thanks to the removal of the additional recovery exchanger and consequent refrigerant circuit simplification.
- Elimination of higher electrical consumption for the ventilation of passive recovery devices, thereby reducing the total energy absorbed.
- In winter mode with heat pump operation, it reduces the formation of ice on the exchanger and therefore the defrosting frequency. The operation continuity and overall efficiency of the system are enhanced.
- Also effective for cooling operations, especially in continental and temperate climates where the output of traditional passive recovery devices is essentially negligible due to a low temperature and enthalpy difference between the outdoor and indoor environment.

# Configurations

## Automatic management of the air flow

### Standard mode

The supply airflow is managed with 0-10V signal. The signal remains constant and keeps the fan speed consistent in all thermal load conditions and operating mode.

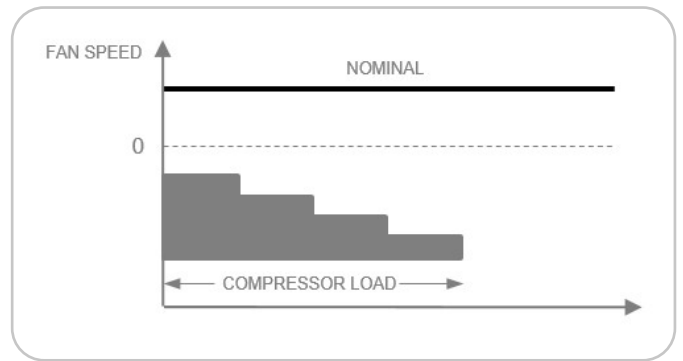

### ECO mode (standard function)

The air flow supply remains constant at varied heat loads and is shutdown when the load is fulfilled. To further increase the energy savings in this condition, it is also possible to set less demanding operation setpoints for the unit in respect to the standard mode.

This function is indicated to thermally maintain a served area when it is temporarily not used, which can for example occur at night. The ECO mode can be activated:

- manually
- automatically by means of the Clivet supervision System

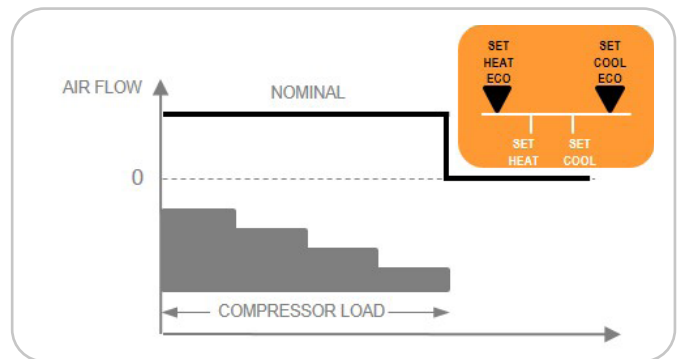

### Constant air flow (PCOSM option)

Supply airflow rate remains constant even with the progressive fouling of the filters compensating for the increased pressure drops.

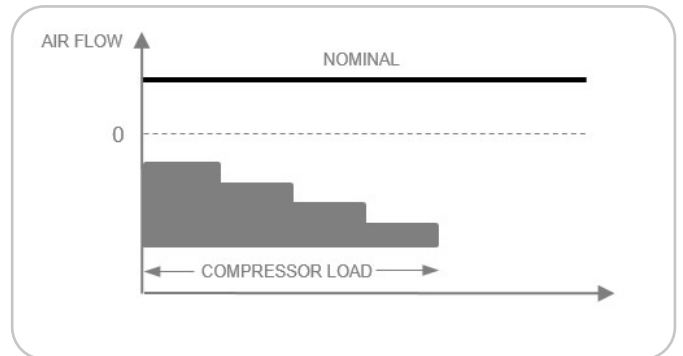

### Variable airflow (PVAR option)

The air flow supply varies depending on the heat load, up to a minimum value compatible with the distribution system and the chosen air diffusion.

The ventilation remains active even when the load is fulfilled.

This option allows a important energy savings as:

- The movement of the air determines an annual energy consumption comparable or even greater than the compressors.
- The reduction of 20% of the flow generates a saving of 50% on energy absorbed by the ventilators.
- With a reduction of the flow equal to 40%, the saving for ventilation exceeds 70%.

The variable airflow can therefore lead to a saving of 30% on the overall electrical consumption of the unit.

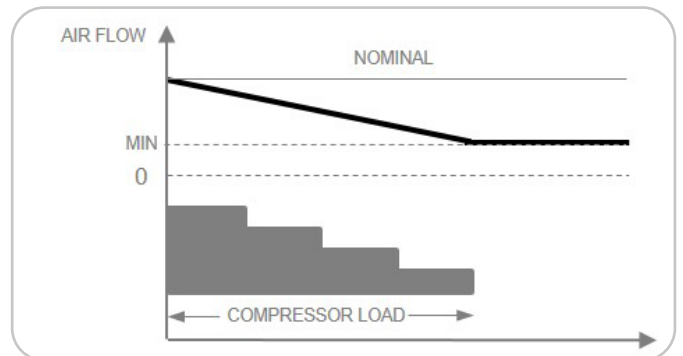

Moreover, the flow rate of the unit can be controlled as follows:

- PVARDP - Variable airflow with pressure probe on the unit
- SPVAR - 0-10 V signal for air flow modulation
- BMS supervision system (not available with Standard mode management of the air flow)

## Smart management of defrosts

The automatic defrosting cycles on surfaces of the external exchanger are managed in a predictive manner, which reduces both the frequency and the duration.

The on-board electronic regulation analyses not only the external conditions but also the changes of the evaporating pressure in the exchanger.

The standard defrosting cycle management involves the stop of the ventilation.

This reduces the time required for defrosting and prevents the introduction of too cold air in the served area, maintaining comfortable conditions for the users.

A specific design of the frame base of the exchanger promotes the outflow of condensation water during defrosting, thereby avoiding the formation of ice at the bottom of the external exchanger.



## Ambient pressure control

The ambient pressure control device compares the return pressure with the external pressure and offsets any variations by acting on the outdoor air damper.

This way, the unit maintains the room at the relative pressure desired by the user, who can choose between overpressure, depression or equal pressure.

The ambient pressure control device is available and supplied as standard in the unit in the configuration with extraction and exhaust (Clivet reference CCK-REVO).

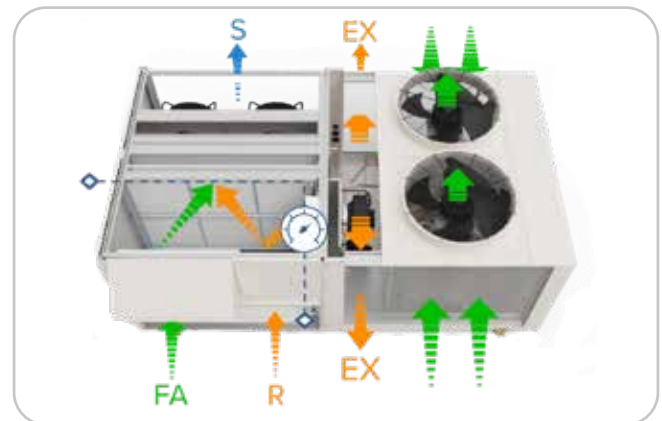

## Simple and intuitive user interface

The remote control with user interface (for wall mounting) is supplied as standard and it can be easily used also by not specialized personnel. The connecting cable (not supplied) has a double function of serial communication and power supply.

Among the main functions it allows to:

- unit switching on and off;
- daily/weekly start-up or power-off programming of the unit and the Comfort or ECO (energy saving) or Ventilation-only mode;
- display the alarm code and the unit statuses;
- management of the main operating parameters (password-protected);
- selective key lock, unlocked with password.

The temperature and humidity measurement is made by probes into the unit: the remote control can therefore be installed also inside the technical control compartment. When the centralised supervision system or an other remote control device is provided, the unit can be supplied without the remote control with the user interface.

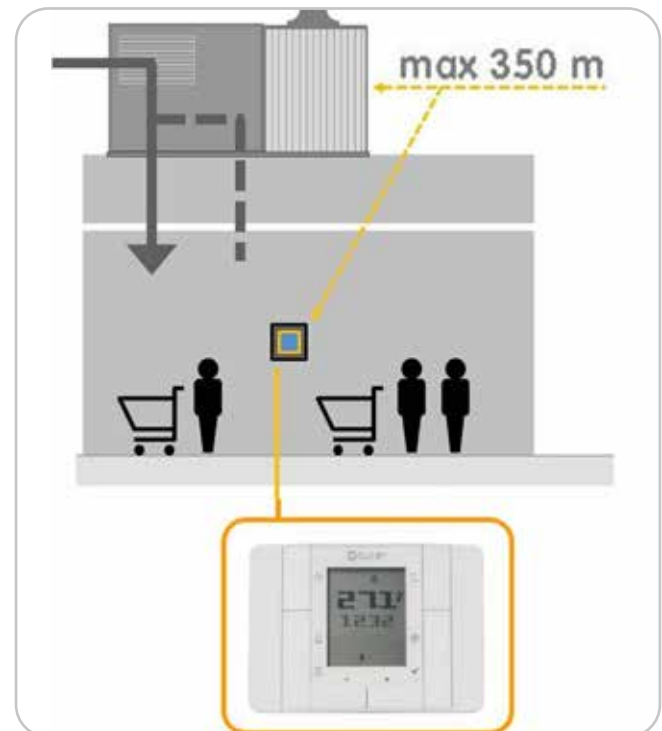



# Unit configuration

## Supply and return configurations

SIZE 60.4 - 70.4 - 80.4 - 90.4 - 100.4 - 120.4

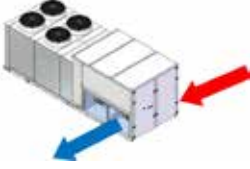
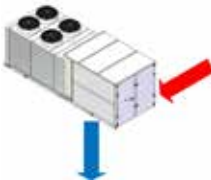
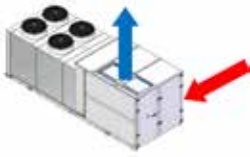
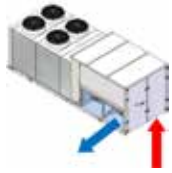
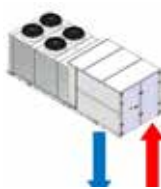
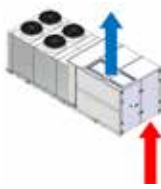
	M0 - R0 Standard Unit	M3 - R0 Option	M5 - R0 Option
SUPPLY AND RETURN OF AIR			
	M0 - R3 Option	M3 - R3 Option	M5 - R3 Option
			

## Filter nomenclature in accordance with EN ISO 16890

The classification of air filters is based on the ability to retain airborne particulate matter.

To make it possible and easier to select appropriate filters according to different applications, a new global standard for filtration has been recently introduced: EN ISO 16890.

It defines a new and alternative classification for air filters based on their ability to retain dispersed airborne particulate matter (PM10, PM2.5 and PM1) through new, more stringent and specific test methods.

The previous standards in force, such as EN 779-2012, ASHRAE 52.2 and other local standards, are thus unified for all countries worldwide.

Below, the correlation between the traditional nomenclature and the new standard for filters used in Clivet units. For easier reading, both names have been kept in the text.

1st stage of filtration (standard)	ISO 16890 Coarse 60%	G4
2st stage of filtration (optional)	ISO 16890 ePM1 55%	F7
2st stage of filtration (optional)	ISO 16890 ePM1 80%	F9
2st stage of filtration (optional)	ISO 16890 ePM1 90%	FIFD (electronic filter iFD)



## 1. Configuration

CAK - Single fan section for full recirculation

CBK - Single fan section for recirculation and fresh air

CBK-G - Single fan section for recirculation, renewal and exhaust

CCK-REVO - Dual ventilating section with renewal air and REVO thermodynamic recovery

## 2. Air supply

M0 - Horizontal supply

M3 - Downflow supply

M5 - Upward supply air

## 3. Air return

R0 - Horizontal return

R3 - Downflow return

## 4. Outdoor air damper

SER - Manual outdoor air damper (std for CBK configuration)

SERM - Outdoor air on/off motorized damper (only configuration CBK)

SFCM - Modulating motorised free-cooling damper (optional for CBK, std for CBK-G and CCK-REVO)

## 5. Auxiliary heating

not required (Std)

EH - Electric heaters

CHW2 - Two-rows hot water coil

GCX - Condensig gas heating module with modulating control

CHWER - Energy recovery from the food refrigeration

## 6. Airflow

not required (Std)

PCOSM - Supply constant airflow

PVAR - Variable airflow

PVARDP - Variable airflow with pressure probe on the unit

SPVAR - 0-10 V signal for air flow modulation

## 7. External section fan

CREFP - Device for consumption reduction of the external section at variable speed (phase-cutting) (Std)

CREFB - Device for fan consumption reduction of the external section, ECOBREEZE type

## 8. Passive energy recovery

EWX - Enthalpy wheel energy recovery Module (only available with CBK-G options)

# Unit configuration

## How to choose the unit

With the same air flow, a different heating-cooling treatment is available based on the size selected.

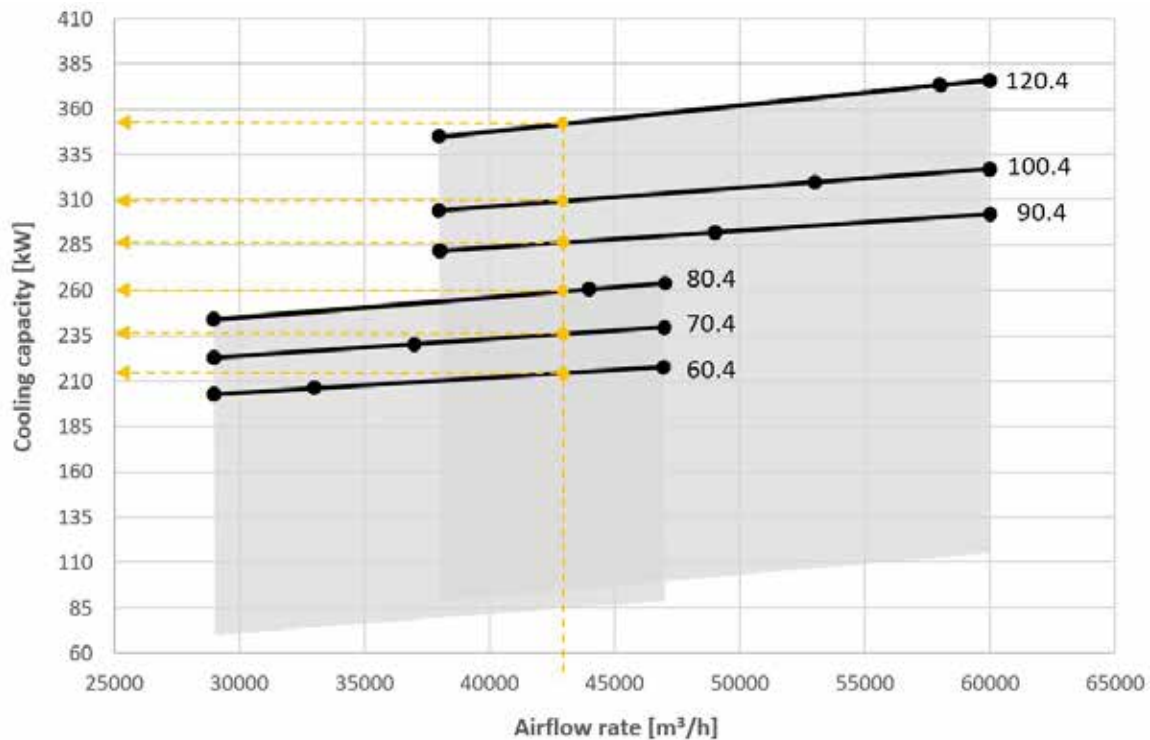

Performance in CCK-REVO configuration, nominal summer conditions and 30% outdoor air

## Compressor

Hermetic orbiting Scroll compressor, equipped with motor protection device for overtemperatures, overcurrents and excessive temperatures of the supply gas. It is installed on antivibration mounts and comes with a full oil charge.

A guard heater with automatic insertion prevents the refrigerant from diluting the oil when the compressor stops.

The compressors are connected in TANDEM on a single refrigeration circuit and have a biphasic oil equalisation.

## Structure

The base is assembled with a painted and hot-dip galvanised steel frame. The internal structure is a load-bearing frame made of shaped Zinc-Magnesium sheet steel. The Zn-Mg alloy improves the features in terms of corrosion resistance due to the galvanic protection typical of the Zinc-Magnesium combination.

## Panelling

Double-walled sandwich panels in the air handling zone made of sheet steel with polyurethane insulation (40 kg/m<sup>3</sup>), 6/10 mm thick external sheet galvanised and painted with RAL 9001 polyester powder, 30 mm thick polyurethane with thermal conductivity coefficient of 0.022W/mK, 5/10 mm thick hot-dip galvanised internal sheet. The panel also has a PVC profile for thermal insulation with an EPDM rubber gasket inserted to ensure an airtight seal.

All panelling can easily be removed to allow complete accessibility to internal components.

## Internal exchanger

Direct expansion finned coil exchanger made with copper pipes placed on staggered rows mechanically expanded to better adhere to the fin collar. The fins are made from aluminium with a corrugated surface and adequately distanced to ensure the maximum heat exchange efficiency.

## External exchanger

Direct expansion finned coil exchanger made with copper pipes placed on staggered rows mechanically expanded to better adhere to the fin collar. The fins are made from aluminium with a corrugated surface and adequately distanced to ensure the maximum heat exchange efficiency.

A correct dimensioning of the exchanger power supplies and the geometry of the structure at the base, prevents the formation of ice at the base of the heat exchanger during winter operation.

## Fan

### Internal section

Plug fans without scroll with reverse blades driven by electronically-controlled "brushless" DC motors with direct coupling. No transmission sizing is needed.

### External section

Helical fans with profiled blades made of reinforced plastic, directly coupled to three-phase electric motor with external rotor with built-in thermal overload protection, IP 54 execution.

## Refrigeration circuit

Double refrigeration circuit with:

- refrigerant charge R32
- high pressure safety pressure switch
- filter dryer
- Steel mesh strainer
- electronic expansion valve
- 4-way reverse cycle valve
- liquid receiver
- liquid separator
- high pressure safety valve
- low pressure safety valve

## Filtration

### Fresh air intake and ambient air return

Folded filter for a larger filtering surface, made of a galvanised sheet metal frame with a galvanised and electro-welded protective mesh and a regenerable filter media made of polyester fibres primed with synthetic resins. ISO 16890 efficiency Coarse 60% (G4). Self-extinguishing type (class 1 flame resistance - DIN 53438).

## Drain pan

### Internal section

Inox steel AISI 304 condensate collection tray with anti-condensate insulation, welded, fitted with drain pipe and UV-resistant silicon siphon.

## Electrical panel

The Power Section includes:

- main door lock isolator switch;
- phase monitor;
- auxiliary circuit protection fuse;
- fan motor thermal protections of internal and extraction section;
- circuit breaker to protect the auxiliary circuit transformer and options.

The microprocessor control section includes:

- treated air temperature control;
- limit supply temperature probe;
- temperature set point and unit switch-on/off daily, weekly programmer;
- compressor timing and protection;
- self-diagnosis system with immediate display of the failure code;
- clean contacts for ON-OFF remote, cumulative alarm, fan mode, compressor mode, summer/winter mode;
- serial communication module for Modbus supervisor.

## Remote control with user interface

- Unit switch-on and switch-off;
- daily/weekly switch-on or switch-off schedule for the unit and for the Comfort, ECO (energy saving) or ventilation-only mode;
- manual change of the operating mode (heat or cool) and/or of the temperature set-point;
- display of the alarm code and unit statuses;
- management of the main operating parameters (password-protected);
- selective key lock, unlocked with a password.

IoT integration (optional):

- Connectivity to the Clivet Eye IoT platform to avail of the cloud based services related to remote control, maintenance and optimization.
- Remote accessibility available via smartphone, tablet and PC by means of responsive interface.

## Test

Unit manufactured to ISO 9001 standard and commissioned upon production completion.

# Standard unit technical features

## Options available

- FC - Thermal FREE-COOLING
- FCE - Enthalpy FREE-COOLING
- CREFB - Device for fan consumption reduction of the external section, ECOBREEZE type
- CHW2 - Two-rows hot water coil
- CHWER - Energy recovery from the food refrigeration
- 2WVM - Modulating 2-way valve
- 3WVM - Modulating 3-way valve
- EH - Electric heaters
- PGFC - Finned coil protection grilles
- PGCC - Anti-hail protection grilles
- PCMO - Sandwich panels of the handling zone in M0 fire reaction class
- CPHG - Hot gas re-heating coil
- M0 - Horizontal supply
- M3 - Downflow supply
- M5 - Upward supply air
- R0 - Horizontal return
- R3 - Downflow return
- SER - Outdoor air damper manually set
- SERM - Outdoor air motorised ON/OFF damper
- SFCM - Modulating motorised FREE-COOLING damper
- NSERG - Gravity exhaust air damper: not required
- VENH - High static pressure supply fans
- PVAR - Variable airflow
- PCOSM - Supply constant airflow
- PVARDP - Variable airflow with pressure probe on the unit
- SPVAR - 0-10 V signal for air flow modulation
- PAQC - Air quality probe for CO<sub>2</sub> rate check
- PAQCV - Air quality probe for CO<sub>2</sub> and VOC rate check
- PAQC2 - Double air quality probe for CO<sub>2</sub> rate check
- PAQCV2 - Double air quality probe for CO<sub>2</sub>+VOC rate check
- PPAQC - External CO<sub>2</sub> signal management
- F7 - F7 high efficiency air filter (ISO 16890 ePM1 55%)
- F9 - F9 high efficiency air filter (ISO 16890 ePM1 80%)
- FIFD - Electronic filters with iFD technology (ISO 16890 ePM1 90%)
- PSAF - Differential pressure switch for dirty air filters
- HSE - Immersed electrodes steam humidifier
- PUE - External Humidifier management with 0-10V external signal
- LTEMP1 - Application for low outdoor temperature
- EXFLOWC - Application in spaces with forced air exhaust at variable flow and exhaust section

## Configuration with single fan section for recirculation, renewal and exhaust (CBK-G)

Same technical features as the structural configuration with a single fan section for all recirculation (CAK) and a single fan section for recirculation and fresh air (CBK), plus:

- **Modulating motorised outdoor air damper for renewal and FREE-COOLING**
- **Gravity exhaust air damper**

## Double ventilation section configuration with air renewal and energy recovery via enthalpy wheel (EWX)

Same technical features as the structural configuration with a single fan section for recirculation, fresh air and exhaust air (CBK-G), plus:

- **Energy recovery of the exhaust air with the EWX enthalpy wheel**

Additional module envisaged on the ambient return section and fresh air intake.

Includes enthalpy wheel, ISO 16890 Coarse 50% filters (G4) and reverse-blade screwless plug-fan exhaust fans driven by EC brushless DC motors.

The module allows to recover the energy content of the exhaust air and reduce the thermal load required by the refrigeration circuit.

## Configuration with dual ventilating section with fresh air and REVO thermodynamic recovery (CCK-REVO)

Same technical features as the structural configuration with a single fan section for all recirculation (CAK) and a single fan section for recirculation and fresh air (CBK), plus:

- **Modulating motorised outdoor air damper for renewal and FREE-COOLING**
- **Exhaust fan**

Reverse-blade screwless plug-fan driven by EC brushless DC motors with direct coupling

- **REVO exhaust air thermodynamic energy recovery (CCK-REVO)**

The energy contained in exhaust air is recovered on a portion of the external exchanger, through a dedicated ventilating section.

The purpose of the recovery is to improve the thermal level of the refrigerant fluid circulating in the exchanger, by varying in a useful way the temperature at which the condensation or evaporation of the operating fluid is completed.

As a result, the favourable air temperature on the source side increases the output and efficiency of the unit.

Clivet has filed a patent on this innovative recovery.

- BRCI - Sloping drain pan
- LON - TP/FT 10 serial port with LonWorks protocol
- BACIP - BACnet-IP serial communication module
- BACMSTP - BACnet-MSTP serial communication module
- SFSTR - Starting current reduction device
- NCRC - Remote control with user interface: not required
- CSOND - Ambient humidity and temperature control with probes on board the unit
- PFCC - Power factor correction capacitors (cosφ > 0.95)
- DESM - Smoke detector
- CONTA2 - Energy meter
- CHMET - Heating and cooling capacity measuring device
- PTCO - Set up for shipping via container

## Accessories separately supplied

GCX - Condensig gas heating module with modulating control

EWX - Enthalpy wheel energy recovery module

AMRX - Rubber antivibration mounts

AMRMX - Rubber antivibration mounts for unit and gas module

AMRUVX - Rubber antivibration mounts for unit and UV-C lamp module

AMREW - Rubber antivibration mounts for unit and enthalpy wheel module

RCX - Roof curb

UVCX - UV-C lamp module with germicidal effect (supplied separately)

MDMTX - Management of ambient temperature probes

MDMTUX - Management of ambient temperature and humidity probes

MDMADX - Advanced monitoring and management ambient probes

CLMX - Clivet Master System

IOTX - IoT industrial module for cloud based interoperability & services

SIX - Service interface (1.5 metre cable)

All the handling coils can be provided with coated aluminium - Fin Guard - copper/copper

## Performances - Standard airflow

Size			60.4	70.4*	80.4*	90.4*	100.4*	120.4*	
<b>Cooling</b>									
Cooling capacity		1	kW	191	215	243	271	298	347
Sensible capacity		1	kW	147	166	192	210	229	262
Compressor power input		1	kW	48,6	54,6	65,4	66,6	74,4	96,0
EER		1	-	3,94	3,93	3,72	4,08	4,00	3,61
Cooling capacity (EN14511:2018)	CAK	5	kW	191,0	213,9	240,7	270,3	296,0	344,0
EER (EN14511:2018)		5	-	3,40	3,40	3,20	3,45	3,42	3,14
SEER		6		4,74	4,69	4,37	4,44	4,31	4,16
$\eta_{sc}$		6	%	186,6	184,7	171,7	174,7	169,5	163,5
Eurovent seasonal efficiency class				A	-	-	-	-	-
Cooling capacity	CBK/ CBK-G	2	kW	199	224	253	282	310	360
Sensible capacity		2	kW	153	173	200	218	239	272
Compressor power input		2	kW	49,1	55,4	66,3	67,4	75,4	97,5
EER		2	-	4,06	4,04	3,81	4,19	4,11	3,70
Cooling capacity	CCK-REVO	3	kW	209	234	265	296	324	378
Sensible capacity		3	kW	159	179	207	226	247	282
Compressor power input		3	kW	47,9	54,0	64,7	65,8	73,6	95,1
EER		3	-	4,36	4,34	4,09	4,50	4,41	3,97
<b>Heating</b>									
Heating capacity	CAK	1	kW	191	212	239	272	296	349
Compressor power input		1	kW	47,3	53,0	59,4	65,3	73,6	95,6
COP		1	-	4,03	3,99	4,02	4,16	4,02	3,64
Heating capacity (EN14511:2018)		7	kW	191,8	213,5	242,7	274,0	298,8	352,5
COP (EN14511:2018)		7	-	3,44	3,44	3,46	3,50	3,43	3,19
SCOP		6		3,41	3,47	3,42	3,42	3,39	3,37
$\eta_{sh}$		6	%	133,5	135,8	133,9	133,9	132,5	132,0
Eurovent seasonal efficiency class				B	-	-	-	-	
Heating capacity	CBK/ CBK-G	2	kW	192	213	240	274	298	350
Compressor power input		2	kW	43,7	49,0	54,9	60,4	68,1	88,1
COP		2	-	4,38	4,34	4,37	4,53	4,37	3,98
Heating capacity	CCK-REVO	3	kW	199	220	248	284	309	363
Compressor power input		3	kW	43,5	48,7	54,6	60,0	67,7	87,6
COP		3	-	4,57	4,53	4,55	4,73	4,56	4,14
Recovery efficiency REVO		4	%	86	86	84	77	78	80

The Product is compliant with the Erp (Energy Related Products) European Directive. It includes the Commission delegated Regulation (EU) No 2016/2281, also known as Ecodesign Lot21.

\*models so marked are not Eurovent certified (out of scope)

Contains fluorinated greenhouse gases (GWP 675)

Performances in cooling: Indoor air temp. 27°C D.B./19°C W.B., entering external exchanger air temperature 35°C D.B./24°C W.B., EER referred only to compressors

Performance in Heating: Indoor air temp. 20°C D.B./12°C W.B., entering air to the external exchanger 7°C D.B./6°C W.B. COP referred only to compressors

1. Full recirculation performance
2. Performance with 30% outdoor air
3. Performance with 30% outdoor air, including energy recovery on exhaust air
4. Energy recovery efficiency determined on exhaust air. Indoor temperature 20°C DB/12°C WB, outdoor temperature 7°C DB/6°C WB
5. Full recirculation capacity according to EN 14511-2018, indoor air temperature 27°C DB/19°C WB; outdoor temperature 35°C. EER in accordance with EN 14511-2018
6. Data calculated in compliance with EN 14825:2018.
7. Full recirculation capacity according to EN 14511-2018, indoor air temperature 20°C; outdoor temperature 7°C DB/6°C WB COP in accordance with EN 14511-2018

# General technical data

## Construction - Standard airflow

Size			60.4	70.4	80.4	90.4	100.4	120.4
<b>Compressor</b>								
Type of compressors			SCROLL	SCROLL	SCROLL	SCROLL	SCROLL	SCROLL
No. of compressors	No.		4	4	4	4	4	4
Refrigeration circuits	No.		2	2	2	2	2	2
Std capacity control steps	No.		4	6	6	6	4	6
Refrigerant charge (C1)	1	kg	28	30	32,5	40	42	47
Refrigerant charge (C2)	1	kg	28	30	32,5	38	40	48
<b>Air Handling Section Fans (Supply)</b>								
Type of supply fan/motor	2		RAD/EC	RAD/EC	RAD/EC	RAD/EC	RAD/EC	RAD/EC
Fan diameter		mm	560	560	560	560	560	560
No. of supply fans	No.		4	4	4	6	6	6
Supply airflow		m <sup>3</sup> /h	33000	37000	44000	49000	53000	58000
Installed unit power		kW	3,5	3,5	3,5	3,5	3,5	3,5
Max. static pressure supply fan	3	Pa	870	760	580	860	810	740
Installed unit power		kW	5,8	5,8	5,8	5,8	5,8	5,8
Max. static pressure supply fan	3	Pa	1395	1230	945	1420	1285	1120
<b>Fans (Exhaust) only configuration CBK-G + EWX</b>								
Type of fans/motor	2		RAD/EC	RAD/EC	RAD/EC	RAD/EC	RAD/EC	RAD/EC
No. of fans			2	2	2	2	2	2
Installed unit power			3,5	3,5	3,5	3,5	3,5	3,5
<b>Fans (Exhaust) only configuration CCK-REVO</b>								
Type of fans/motor	2		RAD/EC	RAD/EC	RAD/EC	RAD/EC	RAD/EC	RAD/EC
No. of fans			2	2	2	2	2	2
Installed unit power			2,67	2,67	2,67	3,95	3,95	3,95
<b>External Section Fans</b>								
Type of fans/motor	4		AXIAL/AC	AXIAL/AC	AXIAL/AC	AXIAL/AC	AXIAL/AC	AXIAL/AC
Fan diameter		mm	800	800	800	800	800	800
No. of fans	No.		4	4	4	6	6	6
Airflow		m <sup>3</sup> /h	84000	84000	84000	126000	126000	126000
Installed unit power		kW	1,72	1,72	1,72	1,72	1,72	1,72
<b>Connections</b>								
Condensate drain		mm	30	30	30	30	30	30
<b>Power supply</b>								
Standard power supply	V		400/3~/50	400/3~/50	400/3~/50	400/3~/50	400/3~/50	400/3~/50

1. Indicative values for standard units with possible +/-10% variation. The actual data are indicated on the label of the unit
2. RAD = Radial fan - EC = Electronically Commutated
3. Net pressure available to overcome flow and return pressure losses
4. AXIAL = Axial fan - AC = Alternating current

## Fan performances

### Size 60.4 Standard fans

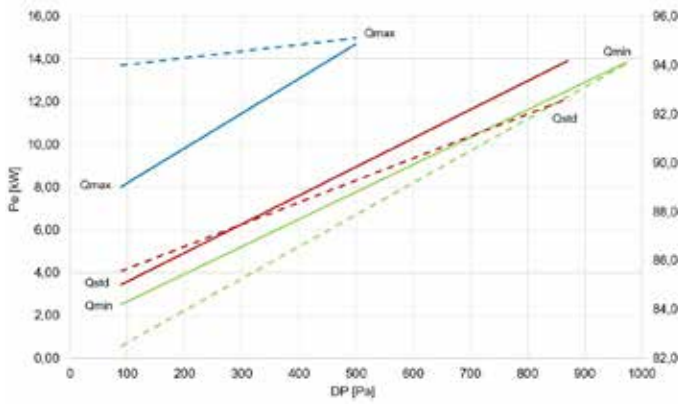

### High static pressure fans

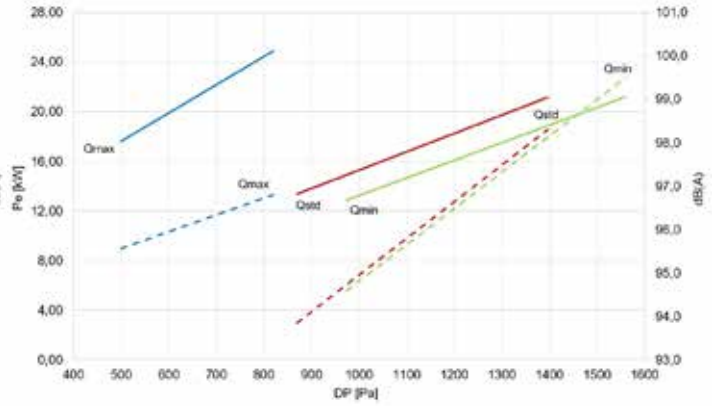

### Size 70.4 Standard fans

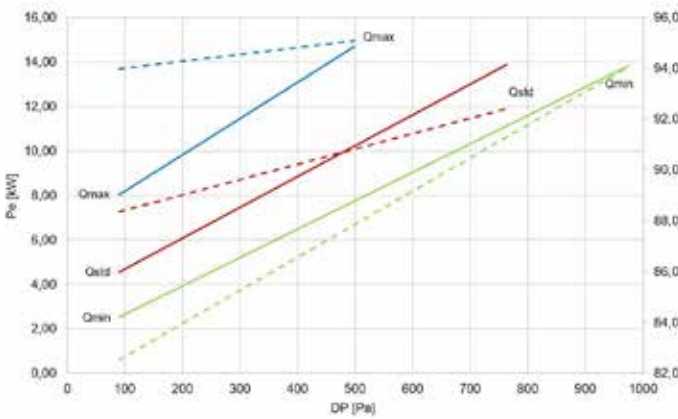

### High static pressure fans

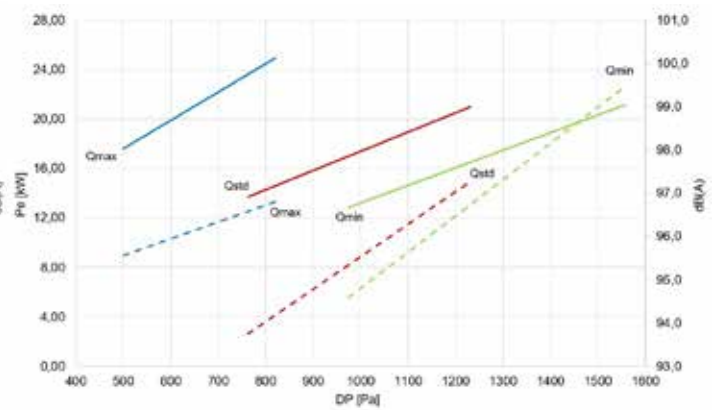

### Size 80.4 Standard fans

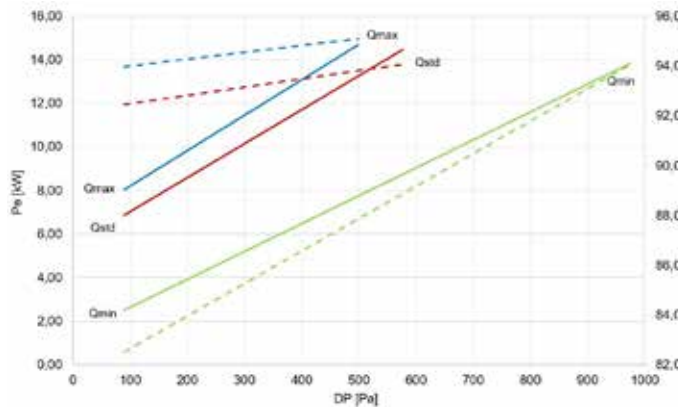

### High static pressure fans

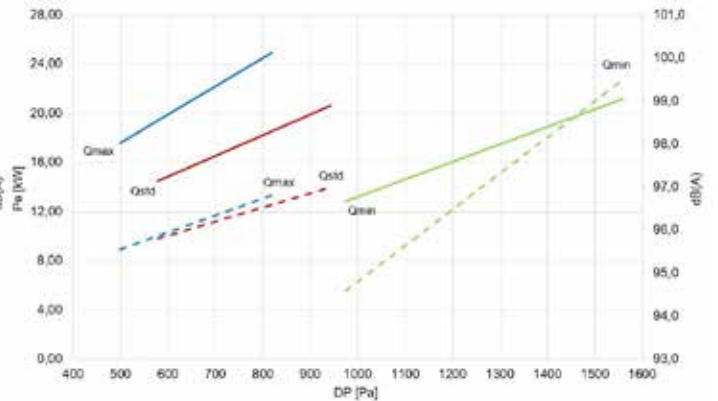

- $Q_{\min/\text{std}/\text{max}}$  = Extracted air flow
- DP = Static supply pressure
- = Pe = Total absorbed electrical power
- = dB(A) = Sound power at the supply section

The performance takes into account the internal pressure drops of the std unit in CAK configuration (handling coil pressure drops, standard filters, etc.). To determine the required performance of the supply fans, the pressure drops of any accessories must be added to the desired available static pressure.



# General technical data

## Size 90.4 Standard fans

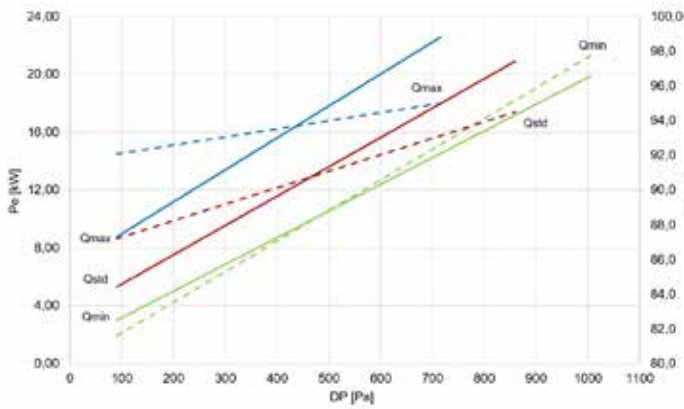

## High static pressure fans

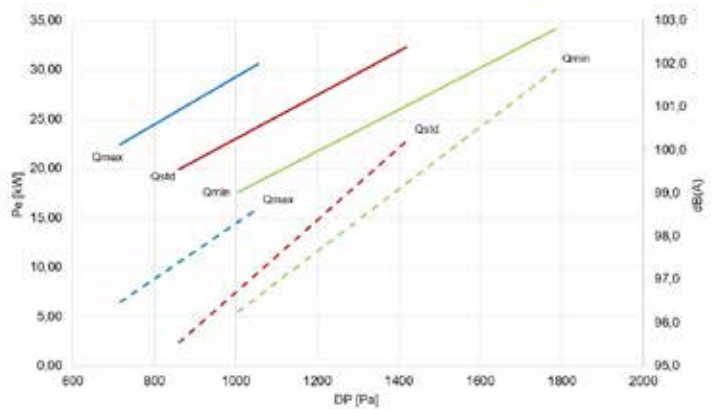

## Size 100.4 Standard fans

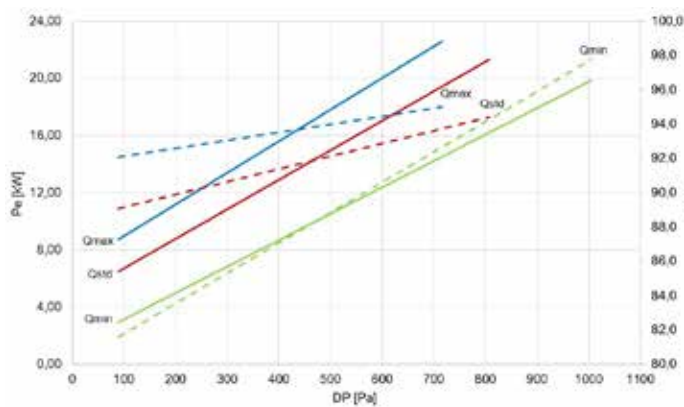

## High static pressure fans

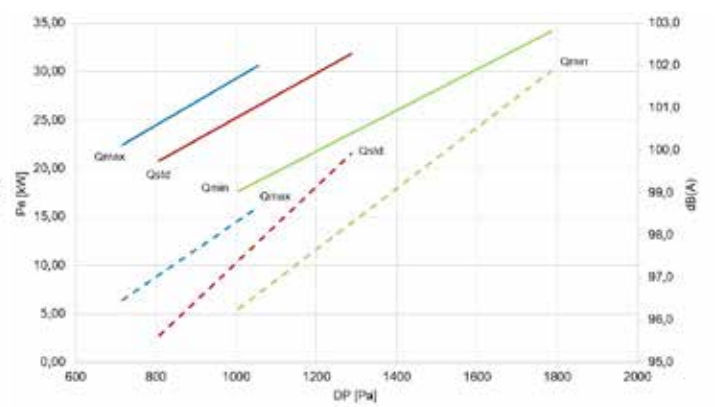

## Size 120.4 Standard fans

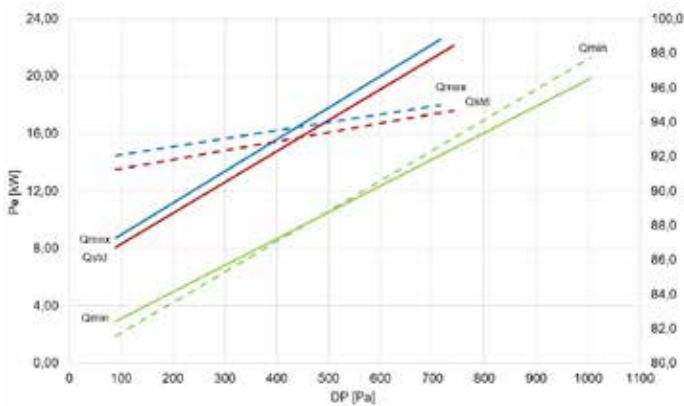

## High static pressure fans

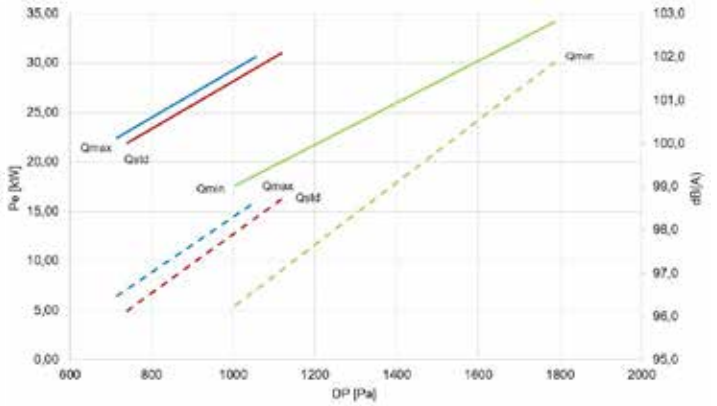

- $Q_{\min/\text{std}/\text{max}}$  = Extracted air flow
- DP = Static supply pressure
- = Pe = Total absorbed electrical power
- = dB(A) = Sound power at the supply section

The performance takes into account the internal pressure drops of the std unit in CAK configuration (handling coil pressure drops, standard filters, etc.). To determine the required performance of the supply fans, the pressure drops of any accessories must be added to the desired available static pressure.

## Extraction fans

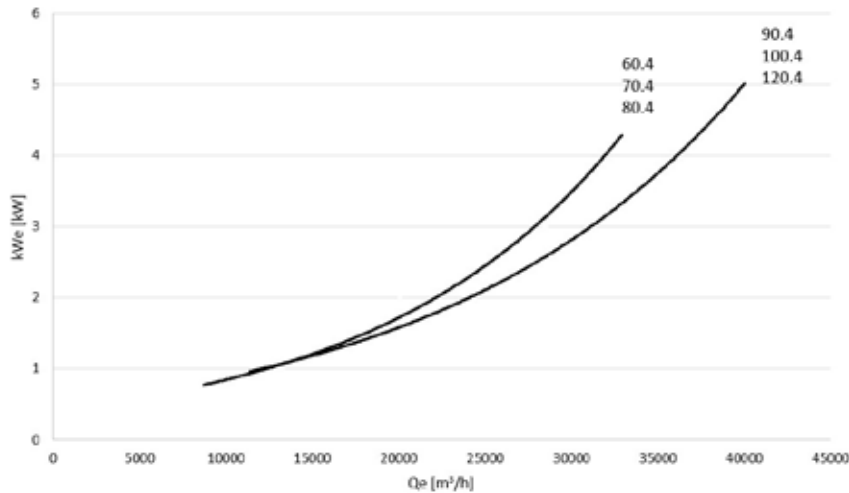

Q<sub>e</sub> = Extracted air flow rate  
P<sub>e</sub> = Total electrical power absorbed

Size		60.4	70.4	80.4	90.4	100.4	120.4
Q <sub>min</sub>	m³/h	29000	29000	29000	38000	38000	38000
Q <sub>std</sub>	m³/h	33000	37000	44000	49000	53000	58000
Q <sub>max</sub>	m³/h	47000	47000	47000	60000	60000	60000

## Sound levels - Standard mode

SIZE	Sound power level (dB)								Sound power level dB(A)	Sound pressure level dB(A)
	Octave band (Hz)									
	63	125	250	500	1000	2000	4000	8000		
60.4	111	98	93	88	86	79	73	84	92	72
70.4	113	99	95	90	88	85	79	82	94	74
80.4	116	102	98	94	91	91	81	83	97	77
90.4	112	100	95	89	88	88	81	75	95	74
100.4	113	101	96	91	89	89	81	76	96	75
120.4	114	102	98	93	93	93	83	76	98	77

The sound levels are referred to unit operating at nominal load in nominal conditions. The sound pressure level is referred at a distance of 1 m from the ducted unit surface operating in free field conditions. External static pressure 50 Pa. (standard UNI EN ISO 9614-1)

Measurements are carried out accordingly to UNI EN ISO 9614-1, as required by Eurovent Certification EUROVENT 8/1. It requires a 2 dB(A) tolerance on sound power level, only acoustic value to be certified.

Please note that when the unit is installed in conditions different from nominal test conditions (e.g. near walls or obstacles in general), the sound levels may undergo substantial variations.

Specific sound performance according to different configuration are available on demand.

## Sound levels referred to ESP as per EN 14511:2018

SIZE		60.4	70.4	80.4	90.4	100.4	120.4
Sound power with casing	dB(A)	92	94	97	95	96	98
Sound power in the duct	dB(A)	87	89	93	89	90	92
Available static pressure	Pa	200	200	250	250	300	300

Data referred to nominal air flow rate.

Measurements are carried out accordingly to UNI EN ISO 9614-1, as required by Eurovent Certification EUROVENT 8/1. It requires a 2 dB(A) tolerance on sound power level, only acoustic value to be certified.

# General technical data

## Pressure drops of optional components

The value of static pressure available on the supply and return duct is obtained by subtracting from the available net maximum pressure (see general table of technical data) the pressure drops of any accessories.

SIZE		60.4	70.4	80.4	90.4	100.4	120.4
CHW2 - Two-rows hot water coil	Pa	31	39	52	43	49	58
CPHG - Hot gas re-heating coil	Pa	19	21	25	22	24	27
CHWER - Energy recovery from the food refrigeration	Pa	59	73	100	84	95	109
F7 - F7 high efficiency air filter (ISO 16890 ePM1 55%)	1 Pa	128	137	152	146	155	167
F9 - F9 high efficiency air filter (ISO 16890 ePM1 80%)	1 Pa	168	177	192	186	195	207
FIFD - Electronic filters with iFD technology (ISO 16890 ePM1 90%)	1 Pa	81	104	153	118	141	172
UVCX - UV-C germicidal lamps module	Pa	80	90	100	110	117	126
EWX - Enthalpy wheel energy recovery module	1, 2 Pa	113	128	120	134	123	135
GCX - Condensing gas heating module	Pa	80	90	100	110	117	126

1. Pressure drops with filters with average dirtiness
2. Pressure drops referring to 30% of outdoor air compared to a standard air flow

The values shown are to be considered approximate for units operating power in normal use with standard air flow rate.

## Electrical data

### Configuration with direct ductable return (CAK) and outdoor air recirculation (CBK/CBK-G)

SIZE		60.4	70.4	80.4	90.4	100.4	120.4
<b>F.L.A. - FULL LOAD CURRENT AT MAX ADMISSIBLE CONDITIONS</b>							
F.L.A. - Total	A	163,1	176,8	195,1	230,3	248,7	284,6
<b>F.L.I. - FULL LOAD POWER INPUT AT MAX ADMISSIBLE CONDITIONS</b>							
F.L.I. - Total	kW	94,5	103,4	114,6	135,5	146,7	171,5
<b>M.I.C. MAXIMUM INRUSH CURRENT</b>							
M.I.C. - Value	A	319,3	380,1	436,3	471,5	489,9	619,7
<b>M.I.C. WITH SOFT START MAXIMUM STARTING CURRENT OF THE UNIT</b>							
M.I.C. with soft start- Value	A	243,3	265,1	305,3	340,5	358,9	441,7

### Configuration with recirculation, exhaust and fresh air and recovery (CCK-REVO)

SIZE		60.4	70.4	80.4	90.4	100.4	120.4
<b>F.L.A. - FULL LOAD CURRENT AT MAX ADMISSIBLE CONDITIONS</b>							
F.L.A. - Total	A	176,1	259,1	277,5	312,7	331	367
<b>F.L.I. - FULL LOAD POWER INPUT AT MAX ADMISSIBLE CONDITIONS</b>							
F.L.I. - Total	kW	102,5	159,4	170,6	191,5	202,7	227,5
<b>M.I.C. MAXIMUM INRUSH CURRENT</b>							
M.I.C. - Value	A	332,3	462,5	518,7	553,9	572,2	702
<b>M.I.C. WITH SOFT START MAXIMUM STARTING CURRENT OF THE UNIT</b>							
M.I.C. with soft start- Value	A	256,3	347,5	387,7	422,9	441,2	524

Data refer to standard units. Power supply: 400/3~/50 Hz. Voltage variation: max. +/-10%  
Voltage unbalance between phases: max 2 %

3. Values not including the accessories. To obtain the value of F.L.A. including accessories, add to the total F.L.A. value that of any accessories (see electrical data of accessories)
4. Values not including the accessories. To obtain the value of F.L.I. including accessories, add to the total F.L.I. value that of any accessories (see electrical data of accessories)

## Electrical input of optional components

To obtain the electrical input of the unit including accessories, add the standard data in Electrical Data table to those for the selected accessories.

SIZE		60.4	70.4	80.4	90.4	100.4	120.4
<b>F.L.A. ABSORBED CURRENT</b>							
F.L.A. EH20 - 24 kW electric elements	A	34,7	34,7	34,7	34,7	34,7	34,7
F.L.A. EH24 - 36 kW electric elements	A	52	52	52	52	52	52
F.L.A. EH28 - 48 kW electric elements	A	69,4	69,4	69,4	69,4	69,4	69,4
F.L.A. HSE8 - Immersed electrodes steam humidifier of 8 kg/h	A	8,7	8,7	8,7	8,7	8,7	8,7
F.L.A. HSE9 - Immersed electrodes steam humidifier of 15 kg/h	A	16,2	16,2	16,2	16,2	16,2	16,2
F.L.A. LTEMP1 -Application for low outdoor temperature	A	1,5	1,5	1,5	1,5	1,5	1,5
F.L.A. VENH - High static pressure supply fans	1	A	13,4	13,4	13,4	20	20
F.L.A. EWX - Enthalpy wheel energy recovery module	A	14	14	14	14	14	14
<b>F.L.I. POWER IMPUT</b>							
F.L.I. EH20 - 24 kW electric elements	kW	24	24	24	24	24	24
F.L.I. EH24 - 36 kW electric elements	kW	36	36	36	36	36	36
F.L.I. EH28 - 48 kW electric elements	kW	48	48	48	48	48	48
F.L.I. HSE8 - Immersed electrodes steam humidifier of 8 kg/h	kW	6	6	6	6	6	6
F.L.I. HSE9 - Immersed electrodes steam humidifier of 15 kg/h	kW	11,3	11,3	11,3	11,3	11,3	11,3
F.L.I. LTEMP1 -Application for low outdoor temperature	kW	0,6	0,6	0,6	0,6	0,6	0,6
F.L.I. VENH - High static pressure supply fans	1	kW	7	7	7	10,4	10,4
F.L.I. EWX - Enthalpy wheel energy recovery module	kW	8,27	8,27	8,27	8,27	8,27	8,27

1. The absorption value that needs to be added on takes into account the difference between the optional high head fans and the standard fans.

# General technical data

## Operating range (Cooling)

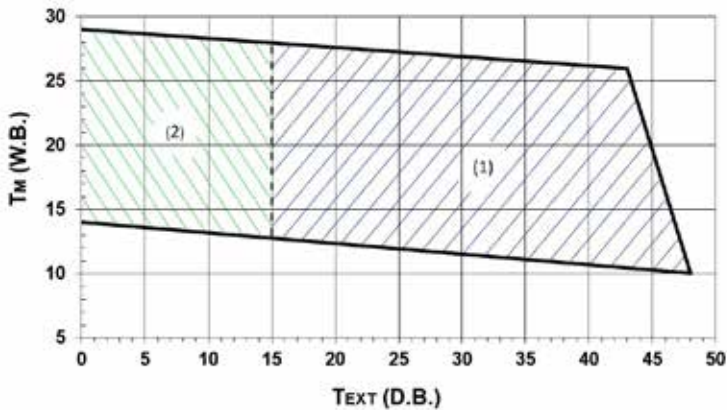

The limits are meant as an indication and they have been calculated by considering:

- general and non specific sizes,
- standard airflow,
- non-critical positioning of the unit and correct operating and maintenance of the unit,
- operating at full load

To verify the operation field of the operating units with percentages of outdoor air, always calculate the  $T_m$  mixing temperature at the internal heat exchanger input.

$T_m$  = Inlet air temperature in the internal exchanger wet bulb temperature (W.B.= WET BULB)

$T_{text}$  = External exchanger inlet air temperature measured temperature with wet bulb (D.B.= DRY BULB)

Within its operating range, the unit can work at a partialized load to maximise energy efficiency

1. Standard unit operating range
2. Operating range of the unit in FREE-COOLING mode (CBK-G and CCK-REVO versions)

### WET BULB TEMPERATURE - EXAMPLE

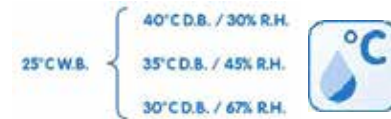

## Operating range (Heating)

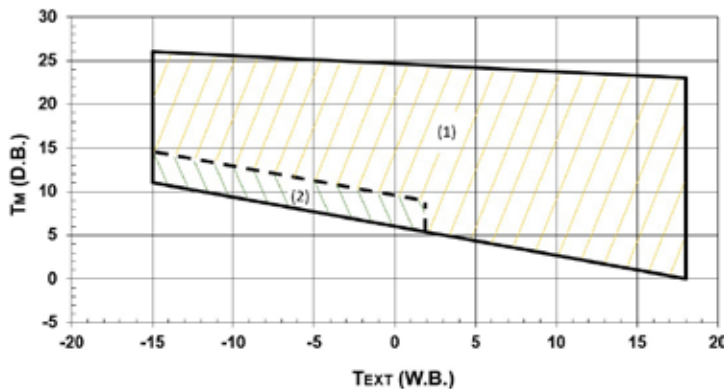

The limits are meant as an indication and they have been calculated by considering:

- general and non specific sizes,
- standard airflow,
- non-critical positioning of the unit and correct operating and maintenance of the unit,
- operating at full load

To verify the operation field of the operating units with percentages of outdoor air, always calculate the  $T_m$  mixing temperature at the internal heat exchanger input.

$T_m$  = Inlet air temperature in the internal exchanger measured temperature with wet bulb (W.B.=WET BULB)

$T_{text}$  = External exchanger inlet air temperature wet bulb temperature (D.B.= DRY BULB)

Within its operating range, the unit can work at a partialized load to maximise energy efficiency

1. Standard operating range
2. Range in which the unit operation is allowed only for a limited period (max 1 hour)

In prolonged heat pump mode with an ambient temperature below 6°C, the unit carries out defrosting cycles with cycle inversion to eliminate the ice that forms on the surfaces of the external exchanger. Moreover, in the event of negative temperatures, it is important to promote the evacuation of water produced by defrosting to avoid the accumulation of ice near the base of the unit. Ensure this does not pose a hazard to property or persons.

With outdoor air temperatures between -10°C and -25°C, the following options will be required:

- Hot water coil / Gas heating module
- Application for low outdoor temperature

# Option compatibility

NAME	DESCRIPTION	CAK	CBK	CBK-G	CCK-REVO
<b>VERSION</b>					
<b>FC</b>	Thermal FREE-COOLING	-	-	√	√
<b>FCE</b>	Enthalpy FREE-COOLING	-	-	0	0
<b>REVO</b>	Exhaust air thermodynamic energy recovery (CCK-REVO)	-	-	-	√
<b>CONFIGURATIONS</b>					
<b>CREFP</b>	Device for consumption reduction of the external section at variable speed (phase-cutting)	√	√	√	√
<b>CREFB</b>	Device for fan consumption reduction of the external section, ECOBREEZE type	0	0	0	0
<b>CHW2</b>	Two-rows hot water coil	0	0	0	0
<b>CHWER</b>	Energy recovery from food refrigeration	0	0	0	0
<b>3WVM</b>	Modulating 3-way valve	0	0	0	0
<b>2WVM</b>	Modulating 2-way valve	0	0	0	0
<b>EH</b>	Electric heaters	0	0	0	0
<b>GCX</b>	Condensig gas heating module with modulating control	◇	◇	◇	◇
<b>EWX</b>	Enthalpy wheel energy recovery module	-	-	◇	-
<b>AMRX</b>	Rubber antivibration mounts	◇	◇	◇	◇
<b>AMRMX</b>	Rubber antivibration mounts for unit and gas module	◇	◇	◇	◇
<b>AMRUVX</b>	Rubber antivibration mounts for unit and UV-C lamp module	◇	◇	◇	◇
<b>AMREWX</b>	Rubber antivibration mounts for unit and enthalpy wheel module	-	-	◇	-
<b>RCX</b>	Roof curb	◇	◇	◇	◇
<b>PGFC</b>	Finned coil protection grilles	0	0	0	0
<b>PGCCH</b>	Anti-hail protection grilles	0	0	0	0
<b>PCM0</b>	Sandwich panels of the handling zone in M0 fire reaction class	0	0	0	0
<b>REFRIGERATION CIRCUIT</b>					
<b>EVE</b>	Electronic expansion valve	√	√	√	√
<b>CPHG</b>	Hot gas re-heating coil	0	0	0	0
<b>AERAUIC CIRCUIT</b>					
<b>M0</b>	Front air outlet	√	√	√	√
<b>M3</b>	Downward air supply	0	0	0	0
<b>M5</b>	Upflow air supply	0	0	0	0
<b>R0</b>	Horizontal air return	√	√	0	√
<b>R3</b>	Downward air return	0	0	√	0
<b>SER</b>	Manual outdoor air damper	-	√	-	-
<b>SERM</b>	ON/OFF motorised outdoor air damper	-	0	-	-
<b>SFCM</b>	Modulating motorised FREE-COOLING damper	-	0	√	√
<b>SERG</b>	Gravity exhaust air damper	-	-	√	-
<b>NSERG</b>	Gravity exhaust air damper: not required	-	-	0	-
<b>VENH</b>	High static pressure supply fans	0	0	0	0
<b>PVAR</b>	Variable airflow	0	0	0	0
<b>PCOSM</b>	Constant supply airflow	0	0	0	0
<b>PVARDP</b>	Variable airflow with pressure probe on the unit	0	0	0	0
<b>SPVAR</b>	0-10 V signal for air flow modulation	0	0	0	0
<b>PAQC</b>	Air quality probe for CO <sub>2</sub> rate check	-	0	0	0
<b>PAQCV</b>	Air quality sensor for CO <sub>2</sub> and VOC rate check	-	0	0	0
<b>PAQC2</b>	Double air quality probe for CO <sub>2</sub> rate check	-	0	0	0
<b>PAQCV2</b>	Double air quality probe for CO <sub>2</sub> +VOC rate check	-	0	0	0
<b>PPAQC</b>	External CO <sub>2</sub> signal management	-	0	0	0
<b>FPG4</b>	Pleated air filter class G4 (ISO 16890 Coarse 60%)	√	√	√	√
<b>F7</b>	High efficiency F7 air filter (ISO 16890 ePM1 55%)	0	0	0	0
<b>F9</b>	High efficiency F9 air filter (ISO 16890 ePM1 80%)	0	0	0	0
<b>FIFD</b>	Electronic filters with iFD technology (ISO 16890 ePM1 90%)	0	0	0	0
<b>PSAF</b>	Clogged filter differential pressure switch air side	0	0	0	0
<b>HSE</b>	Immersed electrodes steam humidifier	0	0	0	0
<b>PUE</b>	External Humidifier management with 0-10V signal	0	0	0	0
<b>LTEMP1</b>	Application for low outdoor temperature	0	0	0	0
<b>EXFLOWC</b>	Application in spaces with forced air exhaust at variable flow and exhaust section	-	-	-	0
<b>UVCX</b>	UV-C germicidal lamps module	◇	◇	◇	◇
<b>BRCI</b>	Sloping drain pan	0	0	0	0

# Option compatibility

NAME	DESCRIPTION	CAK	CBK	CBK-G	CCK-REVO
<b>ELECTRIC CIRCUIT</b>					
<b>MOB</b>	RS485 serial port with Modbus protocol	√	√	√	√
<b>LON</b>	TP/FT 10 serial port with LonWorks protocol	0	0	0	0
<b>BACIP</b>	BACnet-IP serial communication module	0	0	0	0
<b>BACMSTP</b>	BACnet-MSTP serial communication module	0	0	0	0
<b>SFSTR</b>	Disposal for inrush current reduction	0	0	0	0
<b>CRC</b>	Remote control with user interface	√	√	√	√
<b>NCRC</b>	Remote control with user interface: not required	0	0	0	0
<b>CTEM</b>	Ambient temperature control with probes on board the unit	√	√	√	√
<b>CSOND</b>	Ambient temperature control with built-in probes	0	0	0	0
<b>MDMTX</b>	Management of temperature ambient probes	◊	◊	◊	◊
<b>MDMTUX</b>	Management of temperature and humidity ambient probes	◊	◊	◊	◊
<b>MDMADX</b>	Advanced monitoring and management ambient probes	◊	◊	◊	◊
<b>CLMX</b>	Clivet Master System	◊	◊	◊	◊
<b>IOTX</b>	IoT industrial module for cloud based interoperability & services	◊	◊	◊	◊
<b>SIX</b>	Service interface (1.5 metre cable)	◊	◊	◊	◊
<b>PM</b>	Phase monitor	√	√	√	√
<b>PFCC</b>	Power factor correction capacitors (cosfi > 0.95)	0	0	0	0
<b>DESM</b>	Smoke detector	0	0	0	0
<b>CONTA2</b>	Energy meter	0	0	0	0
<b>CHMET</b>	Heating and cooling capacity measuring device	0	0	0	0
<b>DML</b>	Demand Limit	√	√	√	√
<b>VARIOUS</b>					
<b>PTCO</b>	Set up for shipping via container	0	0	0	0

√ Standard component

0 Optional component

◊ Accessory supplied separately (optional)

- Not available

The temperature of the unit is controlled as standard with the temperature probe installed in the return section of the unit.

In the case of configuration with options such as FCE “Enthalpy Free-cooling”, HSE “Immersed electrodes steam humidification”, PUE “External humidifier control with 0-10V signal” and CPHG “Hot gas post-heating coil”, additional humidity probes are installed in the unit. Thermoregulation can also be carried out with the remote probes available as optional components.

To thermoregulate with remote probes, at least three devices must be selected.

---

<b>FC</b>	<b>Thermal FREE-COOLING</b> Standard option for CBK-G and CCK-REVO configurations. It reduces energy consumption and wear of the compressor by using outdoor air as an energy source to reduce thermal loads in the indoor environment. The thermoregulation compares the temperature of the outdoor environment and the environment served by defining the contribution of fresh air required to guarantee the temperature set-point while keeping the compressors off or at reduced load.
<b>CREFP</b>	<b>Device for consumption reduction of the external section at variable speed (phase-cutting)</b> The fan speed is controlled by varying the supply voltage using the phase cutting principle. The source fans operate at variable speed depending on the actual operating conditions of the refrigeration circuit.
<b>CTEM</b>	<b>Ambient temperature control with probes on board the unit</b> Thermoregulation is carried out on the conditions of the return airflow.
<b>SER</b>	<b>Manual outdoor air damper</b> Standard for CBK configuration. The damper on the outdoor section does not change position depending on the operating state and it is opened at the predefined position both when the unit is switched on and when the unit is switched off.
<b>SFCM</b>	<b>Modulating motorised FREE-COOLING damper</b> The modulating motorised free-cooling damper is standard for CBK-G and CCK-REVO configurations and available as an option for the CBK configuration. When the external conditions are favourable, the FREE-COOLING mode is activated and the external air damper is modulated to meet the internal set-point.
<b>MOB</b>	<b>RS485 serial port with Modbus protocol</b> Allows serial connection to supervision systems, using Modbus as a communication protocol. Provides access to the entire list of operation variables, controls and alarms. The device is installed and wired on the unit.   The total length of each individual serial line must not exceed 1000 m and the line must be connected in bus type (input/output).
<b>PM</b>	<b>Phase monitor</b> The phase monitor allows verifying the proper phase connection and their unbalance in the units powered by the three-phase system. The monitor communicates with the control circuit and orders the switch-off of the unit should one of the following cases occur: improper phase connection; the limit value referring to the unbalance between the phases is exceeded; over/under-voltage for a certain amount of time. As soon as the nominal line conditions are restored, the unit is automatically reset. The device is installed and wired on the unit.
<b>DML</b>	<b>Demand limit</b> Partial or total activation of the compressors - and electric heaters where present - can be disabled to limit the overall power input. This function is manageable via BMS, through parameter or 0-10V external signal. Higher the signal and lower is the capacity the unit can deliver activating compressors, electrical resistances and auxiliary heating systems. Demand Limit function does not affect the control, the ventilation or the energy recovery from food refrigeration, which are therefore always guaranteed.

---



## FCE Enthalpy FREE-COOLING

This option is used to reduce energy consumption and compressor wear by using the outdoor air as an energy source to lower the thermal loads and ambient humidity. The temperature control compares the temperature and the humidity between the outdoor environment and the served environment and decides the amount of fresh air needed to guarantee the correct temperature and humidity set-points in the environment, keeping the compressors off or at a reduced load.

The air humidity, both outside and inside the environment, is measured by means of humidity probes on the outdoor and return air intake, which are provided already installed and wired on the unit.

## CREFB Device for fan consumption reduction of the external section, ECOBREEZE type

Option indicated to reduce the ventilation electric energy consumption considerably and limit sound emissions inside the external section of the unit. ECOBREEZE logic allows the external axial fans to operate at a variable rotation speed, according to the operating conditions of the cooling circuit. Reducing the speed at which the thermal load decreases ensures clear benefits in terms of noise emissions especially at night when people can be most sensitive to noise.

During summer operation, fans can further increase their speed, to respond to situations in which operation limits are temporarily exceeded. ECOBREEZE option uses special fans powered by brushless electrical motors, with complete electronic control, and distinguished by a very high efficiency.

To ensure continuous cooling operation even at temperatures below 15°C, the option is necessary to maintain correct condensation on the external heat exchanger.



## BRCI Sloping drain pan

Option to fit a sloping drain pan under the handling coil. Thanks to the easy condensate drainage, washing is facilitated and the proliferation of viruses and bacteria is prevented.

⚠ For the condensate to drain correctly, the unit must be raised.

## LON TP/FT 10 serial port with LonWorks protocol

Allows serial connection to supervision systems, using LonWorks as a communication protocol. Provides access to a list of operation variables, controls and alarms compliant with the Echelon standard. The device is installed and wired on the unit.

⚠ The configuration and operation of the LonWorks network is provided by the Customer.

⚠ LonWorks technology uses the LonTalk® protocol for communicating between the network nodes. Contact the service supplier for further information.

⚠ The total length of each individual serial line must not exceed 1000 m and the line must be connected in bus type (input/output).

## BACIP BACnet-IP serial communication module

Allows connection to supervision systems, using BACnet-IP as a communication protocol. Provides access to the entire list of operation variables, controls and alarms. The device is installed and wired on the unit.

⚠ The configuration and management activities for the BACnet networks are the responsibility of the client

⚠ The total length of each individual serial line must not exceed 1000 m and the line must be connected in bus type (input/output).

## BACMSTP BACnet-MSTP serial communication module

Allows connection to supervision systems, using BACnet/MSTP as a communication protocol. Provides access to the entire list of operation variables, controls and alarms. The device is installed and wired on the unit.

⚠ The configuration and management activities for the BACnet networks are the responsibility of the client

⚠ The total length of each individual serial line must not exceed 1000 m and the line must be connected in "input/output" type.

## NCRC Remote control with user interface: not required

Choosing this option results in the unit being supplied without a graphical control user interface, although it retains all the features. Option that can be chosen when a supervision system or other remote management device is provided.

⚠ Remote control with user interface can still be used in conjunction with a supervision system and more generally with a serial connection

**PFCC Power factor correction capacitors (cosfi > 0.95)**

Component required to lower the phase shift between the current and voltage in the unit's electromagnetic components (e.g. asynchronous motors). By correcting the power factor, it is possible to reduce the line current intensity by reducing a portion of power from the grid (reactive power). This results in savings on costs acknowledged by the energy supplier to the end user. The component makes it possible to raise the cosfi power factor to values on average greater than 0.95. The device is installed and wired on the unit.

**SFSTR Disposal for inrush current reduction**

This option is also called 'Soft starter'. An electronic device that automatically starts the compressors gradually, reducing the unit's starting current by approximately 40% of the nominal value. As a result, the electrical power system and related protection devices can be designed with lower parameters and therefore with a lower initial investment cost. The device is installed and wired on the unit.

**VENH High static pressure supply fans**

A higher capacity fan section is available for applications requiring high supply and return head. The option is comprised of radial fans coupled directly to electronically controlled motors (brushless). When you select a unit on the [www.clivet.com](http://www.clivet.com) website, choose the air flow, the available supply and return pressure, and the accessories that determine the head loss on the air side, you will be automatically shown a selection of high head fans, when required. This option involves variation of the main electrical data of the unit.



**PSAF Clogged filter differential pressure switch air side**

It detects and signals when the maximum level of clogging of the air filters has been reached. This alerts the machine operator when maintenance of the filters is required. The detection device is installed in the unit and already connected to the electrical panel of the machine and pre-calibrated in the factory. The calibration can be modified by authorised personnel.



**F7 High efficiency F7 air filter (ISO 16890 ePM1 55%)**  
**F9 High efficiency F9 air filter (ISO 16890 ePM1 80%)**

Class F7/F9 filters are additional filtration components along with the standard G4 filters for more efficient filtration. They are widely used in civil air conditioning systems and in industrial applications requesting an adequate yield with respect to fine dust and particles larger than 1 µm. Class F7/F9 filters are made of folded fibreglass paper with constant calibrated spacing, mounted on a metal frame; the large filtering surface is designed to keep air side pressure drops low. Class F7/F9 filters must be replaced after reaching clogging limits with scheduled periodic maintenance. It is possible to provide, as an option, the differential pressure switch for dirty filters to inform the user that the permissible clogging limit has been reached to avoid an excessive reduction in the airflow rate compared to the rated value.



⚠ This option reduces the available static pressure (supply air side).

**SERM ON/OFF motorised outdoor air damper**

Option available for CBK configuration. The position of the external air damper is closed when the unit is switched off to avoid leakage, and during the start-up phase to reach the set-point more quickly. When the unit is switched on and running, it opens and allows the passage of the set flow of outdoor air.

## FIFD

### Electronic filters with iFD technology (ISO 16890 ePM1 90%)

High efficiency filters with active electrostatic system with an intense dielectric field are additional filtration components to standard ISO 16890 Coarse 60% filters (G4). They are effective on a wide range of pollutants, including pollen, dust, microdust and nanodust, toners, moulds, smog, bacteria and viruses with a typical efficiency up to 99.99%. The air filtration process follows the most advanced air purification technologies and consists of these phases:

- First pre-filtration phase
- Second ionisation phase, in which the particles are charged by passing through a thin perforated metal plate with needle electrodes in the centre of each hole.
- Third absorption phase, in which the charged dust particles are captured by a strong and intense dielectric field formed by a honeycomb tube.

The iFD electronic filters have a very high filtration efficiency with low pressure drops and therefore reduced ventilation consumption compared to traditional filters. The typical air crossing speeds reached in Clivet units ensure filtration efficiencies higher than ISO 16890 ePM1 90% (equivalent to class E10 of absolute filters in accordance with EN 1822).

For this result to be guaranteed and the microbicidal action against bacteria and viruses to be kept steady over time while ensuring minimum load drops, the filters require proper maintenance. This is extremely simple and is done by washing them with a standard kitchen degreaser. This means that the filter cell does not need replacing, just washing.

Filters must be cleaned at least every six months; we recommend quarterly or more frequent cleaning if the units are located in excessively polluted areas. Intervention on the filters during the unit's routine maintenance includes washing the electronic cells on site.

The higher initial cost, compared to a traditional mechanical filter, can be amortised in a short time. Indeed, the lifecycle of the electrostatic filters is the same as that of the unit, whereas mechanical filters need to be replaced periodically.

- ⚠ This option reduces the available static pressure (supply air side).
- ⚠ iFD electronic filters are not suitable for filtering water vapours even in low concentrations, oily vapours, large quantities of dust, shavings and iron filing dust, residues in general and gases.
- ⚠ All the following substances must be absolutely avoided with electronic filters: metallic material dust, even if very fine; fumes produced by the combustion of organic and non-organic materials; flour dust; dust and vapours from potentially explosive atmospheres.

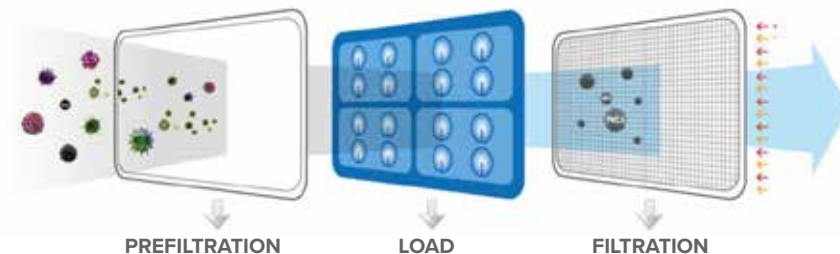

## NSERG

### Gravity exhaust air damper not required

Option that allows configuration of the unit in CBK-G version without gravity exhaust air damper.

It is suitable for applications that require the expulsion of air directly into the building. This solution is compatible with the return section in position R0 (Horizontal).

## PCOSM

### Constant supply airflow

The technology used avoids the need for on-site calibration of traditional fans, as well as time and costs associated to do it. The required flow rate is set on the display and maintained automatically by the unit, which controls the speed of the ventilating sections. During the installation and start-up phase, the unit controls to the effective pressure drop in the air distribution and diffusion system. Furthermore, during its entire operating life, the progressive fouling of the air filters is automatically compensated.



## PVAR

### Variable airflow

Option that enables the automatic variation of the treated air flow, according to the effective load. This allows great energy saving, thanks to the reduction of ventilation electrical consumptions. The minimum flow value equal to 60% of the nominal one occurs during the partial load and satisfied set-point operation. As a result, the supply temperature remains unchanged either during full load operation or partial load operation. The device also includes the functions to configure the nominal flow directly on the unit display, and its automatic control to compensate the dirtying of the air filters.



- ⚠ This option already includes the device for controlling the airflow, called 'PCOSM - Supply constant airflow', which must not be selected
- ⚠ When sizing the distribution and diffusion of the air, keep into consideration that the airflow varies from the nominal value (at full load, in FREE-COOLING mode and during the defrosting phases) to the minimum value, equal to 60% of the nominal flow (at partial load)

## PVARDP

### Variable airflow with pressure probe on the unit

This option is recommended in applications for multi zone where is required the variability of the air flow, actual conditions of use of certain rooms. Suitable for aeraulic system equipped with VAV/CAV dampers. In case of variation of the aeraulic load profile of the system, it allows to automatically change the air flow rate to maintain the set external static pressure.

- ⚠ For effective control, the set external static pressure must be higher than 100 Pa
- ⚠ Supply air flow rate must result inside the admitted air flow range specific for each size

## PAQC

### Air quality probe for the CO<sub>2</sub> rate check

This option is recommended for areas with highly variable crowding. The probe measure the amount of CO<sub>2</sub> in the environment and initiates a proportional signal. Based on the received signal, the controller regulates amount of outdoor air necessary for IAQ ventilation and thus minimises energy used for treatment. The probe is installed and wired built-in the unit and is located in the return air duct of the unit.



- ⚠ This solution can only be provided in combination with 'SFCM Modulating motorised FREE-COOLING damper'

## PAQCV

### Air quality probe for the CO<sub>2</sub> and VOC rate check

The option is recommended in areas with tobacco smoke, formaldehyde (from solvents, deodorants, glues, paints, detergents, food preparation, etc). The probe measures the rate of CO<sub>2</sub> and VOC (volatile organic compounds) in the environment and initiates a proportional signal. Based on the received signal, the controller regulates amount of outdoor air necessary for IAQ ventilation and thus minimises energy used for treatment. The probe is installed and wired built-in the unit and is located in the return air duct of the unit.

- ⚠ This solution can only be provided in combination with 'SFCM Modulating motorised FREE-COOLING damper'

## PAQC2

### Double air quality probe for CO<sub>2</sub> rate check

Option suitable for environments with highly variable crowding and outdoor pollution. The option entails two CO<sub>2</sub> probes: one on board the unit and one outside the building. Depending on the two concentrations recorded, the unit logic intervenes to introduce the correct air flow or no fresh air at all.

- ⚠ This solution can only be provided in combination with 'SFCM Modulating motorised FREE-COOLING damper'

## PAQCV2

### Double air quality probe for CO<sub>2</sub>+VOC rate check

Option suitable for environments with highly variable crowding and outdoor pollution and containing tobacco smoke, formaldehyde (e.g. from solvents, deodorants, glues, paints, detergents), cooking food, etc. The option entails two CO<sub>2</sub>+VOC (Volatile Organic Compound) probes: one on board the unit and one outside the building. Depending on the two concentrations recorded, the unit logic intervenes to introduce the correct air flow or no fresh air at all.

- ⚠ This solution can only be provided in combination with 'SFCM Modulating motorised FREE-COOLING damper'

## PPAQC

### External CO<sub>2</sub> signal management

The unit is configured with a 0-10V input available for the proportional control of the amount of fresh air according to a signal from a CO<sub>2</sub> detection system to be taken care of by the customer.

- ⚠ This solution can only be provided in combination with 'SFCM Modulating motorised FREE-COOLING damper'

# Accessories

---

## **CSOND** Temperature and humidity ambient control with built-in probes

This option makes it possible to measure the temperature and humidity of the ambient directly on the airflow entering the unit. The automatic thermal regulation is done using the on-board probes, whereas the probes on the remote control are inhibited.

---

## **PGFC** Finned coil protection grilles

Protection grilles on the external exchangers (source side) are provided.

The grilles have a protective and safety functions, in order to prevent vandalism and accidental impacts without altering the heat exchange. It consists of a rigid wire mesh with 25 mm mesh pitch and grey RAL7073 protective coating.

---

## **PGCCH** Anti-hail protection grilles

Option to install protective grilles on the external exchangers (source side). The grille has a protective function to prevent vandalism and to protect against atmospheric agents such as hail, without altering heat exchange.

It consists of a rigid wire mesh with a 12.5 mm mesh pitch and RAL7073 grey protective paint.

---

## **CONTA2** Energy meter

Allows to display and record the unit's main electrical parameters.

The data can be displayed with the user interface on the unit or via the supervisor through the specific Modbus protocol. It is possible to control:

- voltage (V),
- absorbed current (A),
- frequency (Hz),
- phase shifting  $\cos \varphi$
- power input (kW),
- absorbed energy (kWh),
- harmonic components (%)

⚠ The device is installed and wired on the unit.

⚠ This device is an accurate meter with CE certification; not suitable for legal metrology findings.

---

## **CHMET** Cooling and Heating Capacity Meter

System to calculate the heating and cooling capacity by measuring the enthalpy of the supply and return air and the outdoor environment, as well as the indirect measurement of the supply and fresh airflow.

The data can be read directly on the device or through the supervision system with a ModBus communication protocol.

⚠ The device is installed and wired on the unit.

⚠ The capacities detected are to be considered indicative of the operation and the actual work point of the unit and are not comparable to the accuracy of the precise laboratory performance data declared in the Technical Bulletin.

## CPHG

### Hot gas re-heating coil

This option is recommended during the summer when the intake air dehumidification is required.

The air flow to enter the room may contain a higher level of humidity than desired. The dehumidification process is used to reduce it. The air flow is first cooled in the handling coil with separation of condensation. It is then freely re-heated to maintain the desired condition of comfort in the served room.

The re-heat coil is located after the handling coil and is activated by diverting a flow of hot refrigerant gas downstream from the compressors through the action of a dedicated solenoid valve.

The process starts operating based on the humidity set-point established by the user.

With respect to traditional devices, such as electrical electric elements or hot water coils, use of the re-heat coil does not consume any extra energy. It also lowers refrigerant condensation temperature, which provides two positive effects: power absorbed by the compressors is considerably reduced, and at the same time, cooling capacity is increased, resulting in greater efficiency (EER). Ambient humidity is measured by means of a return humidity probe, which is provided already assembled and wired built-in the unit.

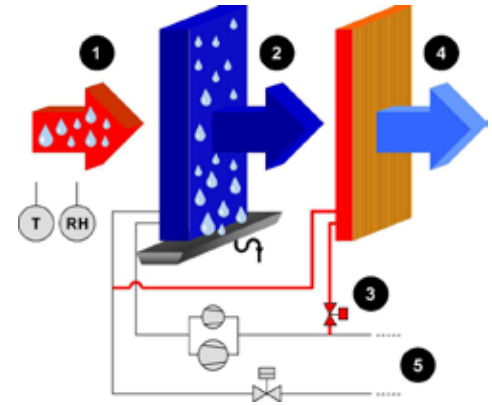

1. Outdoor air and humidity / temperature probe
2. Chilled and dehumidified air in the internal exchanger (evaporator)
3. Automatic hot gas pump valve
4. Air treated by the post-heating exchanger
5. External exchanger (condenser)

Indicative scheme - not in scale

⚠ This option reduces the available static pressure (supply air side).

SIZE		OUTDOOR AIR TEMPERATURE [°C]															
		25	27	30	32	35	25	27	30	32	35	25	27	30	32	35	
		kWt	kWt	kWt	kWt	kWt	kWt	kWt	kWt	kWt	kWt	kWt	kWt	kWt	kWt		
60.4	Qo [m³/h]	29000					33000					47000					
	Qo [l/s]	8056					9167					13056					
	Ta [°C]	10	67,9	73,0	80,9	86,2	94,3	74,0	79,8	88,3	94,2	103,0	90,0	96,9	107,5	114,6	125,3
		12	62,5	67,8	75,6	80,9	88,9	68,2	73,9	82,5	88,2	97,0	82,9	89,9	100,3	107,4	118,1
		14	57,3	62,5	70,3	75,5	83,5	62,5	68,2	76,7	82,4	91,1	75,9	82,8	93,2	100,3	110,9
		16	52,1	57,2	65,0	70,2	78,1	56,9	62,5	71,0	76,7	85,3	69,0	75,9	86,1	93,2	103,7
		18	47,0	52,0	59,7	64,9	72,8	51,2	56,8	65,2	70,8	79,4	62,0	68,9	79,2	86,1	96,7
	20	41,8	46,9	54,6	59,7	67,5	45,5	51,2	59,5	65,1	73,7	55,2	62,0	72,3	79,2	89,7	
	70.4	Qo [m³/h]	29000					37000					47000				
		Qo [l/s]	8056					10278					13056				
		Ta [°C]	10	68,5	73,8	81,7	87,1	95,3	79,2	85,3	94,5	100,8	110,2	90,9	97,9	108,6	115,7
12			63,1	68,4	76,3	81,6	89,8	73,0	79,1	88,2	94,5	103,8	83,7	90,8	101,3	108,5	119,2
14			57,9	63,1	71,0	76,2	84,3	66,9	72,9	82,1	88,2	97,7	76,7	83,7	94,2	101,3	112,0
16			52,6	57,9	65,7	71,0	78,9	60,7	66,8	75,8	82,0	91,3	69,6	76,7	87,0	94,2	104,8
18			47,4	52,6	60,4	65,6	73,5	54,7	60,7	69,7	75,8	85,0	62,7	69,6	80,0	87,0	97,7
20		42,2	47,4	55,1	60,3	68,2	48,7	54,7	63,7	69,7	78,9	55,8	62,7	73,0	80,0	90,5	
80.4		Qo [m³/h]	29000					44000					47000				
		Qo [l/s]	8056					12222					13056				
		Ta [°C]	10	69,2	74,6	82,5	88,0	96,1	87,6	94,3	104,5	111,4	121,9	91,7	98,9	109,7	116,9
	12		63,8	69,1	77,1	82,5	90,6	80,6	87,5	97,6	104,5	114,8	84,6	91,6	102,3	109,6	120,5
	14		58,4	63,7	71,6	77,0	85,1	73,8	80,6	90,6	97,6	107,9	77,4	84,5	95,2	102,3	113,2
	16		53,1	58,4	66,3	71,6	79,6	67,1	73,8	83,8	90,6	101,0	70,3	77,3	87,9	95,0	105,8
	18		47,9	53,1	60,9	66,2	74,3	60,4	67,1	77,0	83,8	94,1	63,4	70,3	80,7	87,9	98,7
	20	42,7	47,9	55,7	60,9	68,9	53,8	60,4	70,4	77,0	87,2	56,3	63,3	73,8	80,7	91,4	
	90.4	Qo [m³/h]	38000					49000					60000				
		Qo [l/s]	10556					13611					16667				
		Ta [°C]	10	88,6	95,3	105,5	112,4	122,9	102,4	110,3	122,2	130,3	142,4	115,5	124,4	137,8	147,0
12			81,6	88,4	98,6	105,5	115,8	94,5	102,4	114,1	122,2	134,3	106,5	115,4	128,7	137,8	151,5
14			74,8	81,6	91,6	98,6	108,9	86,6	94,4	106,1	114,1	126,1	97,6	106,5	119,7	128,7	142,3
16			68,1	74,8	84,8	91,6	102,0	78,7	86,5	98,2	106,1	118,1	88,7	97,6	110,8	119,7	133,2
18			61,4	68,1	78,1	84,8	95,0	70,9	78,7	90,3	98,2	110,1	79,9	88,7	101,8	110,8	124,2
20		54,8	61,4	71,3	78,0	88,2	63,2	70,9	82,5	90,3	102,1	71,2	79,9	93,0	101,9	115,2	

Ta = Leaving air temperature from the handling coil and entering the post-heating coil

Qo = airflow (l/s and m3/h)

kWt = Heating capacity (kW)

The reheating coil is powered by the hot gas bled from the condensing coil.

As the condensation hot gas temperature is linked to the outdoor air temperature, the indicative potentials of the post-heating coil are expressed according to the outdoor air temperature

# Accessories

## CPHG

SIZE	OUTDOOR AIR TEMPERATURE [°C]																
	25	27	30	32	35	25	27	30	32	35	25	27	30	32	35		
	kWt	kWt	kWt	kWt	kWt	kWt	kWt	kWt	kWt	kWt	kWt	kWt	kWt	kWt	kWt		
100.4	Qo [m³/h]	38000					53000					60000					
	Qo [l/s]	10556					14722					16667					
	Ta [°C]	10	89,0	95,7	106,0	113,0	123,5	107,4	110,4	122,3	130,3	142,5	116,1	125,1	138,6	147,7	161,5
		12	82,1	88,9	99,1	106,0	116,4	99,1	102,4	114,2	122,3	166,6	107,0	115,9	129,4	138,5	152,2
		14	75,2	82,0	92,2	99,0	109,5	90,8	94,5	106,2	114,2	126,2	98,0	107,0	120,3	129,4	143,0
		16	68,4	75,1	85,3	92,1	102,4	82,5	86,6	98,3	106,2	118,1	89,1	98,0	111,4	120,3	133,9
		18	61,7	68,4	78,4	85,3	95,5	74,4	78,7	90,3	98,3	110,1	80,3	89,1	102,3	111,3	124,9
		20	55,0	61,6	71,7	78,4	88,7	66,2	70,9	82,5	90,3	102,2	71,5	80,3	93,4	102,3	115,7
	120.4	Qo [m³/h]	38000					58000					60000				
		Qo [l/s]	10556					16111					16667				
Ta [°C]		10	89,4	96,3	106,6	113,6	124,1	114,1	110,9	122,9	131,0	143,2	116,7	125,6	139,3	148,5	162,4
		12	82,5	89,3	99,6	106,5	117,0	105,3	102,9	114,8	122,8	135,0	107,6	116,5	130,0	139,3	153,0
		14	75,6	82,4	92,6	99,6	110,0	96,4	94,9	106,7	114,8	126,8	98,6	107,5	120,9	130,0	143,8
		16	68,8	75,6	85,7	92,5	103,0	87,7	87,0	98,8	106,7	118,7	89,5	98,5	111,9	120,9	134,5
		18	62,0	68,8	78,9	85,7	96,0	79,0	79,1	90,8	98,8	110,7	80,7	89,5	102,9	111,9	125,4
	20	55,3	61,9	72,1	78,8	89,1	70,3	71,3	82,9	90,8	102,7	71,8	80,6	93,8	102,9	116,4	

Ta = Leaving air temperature from the handling coil and entering the post-heating coil

Qo = airflow (l/s and m3/h)

kWt = Heating capacity (kW)

The reheating coil is powered by the hot gas bled from the condensing coil.

As the condensation hot gas temperature is linked to the outdoor air temperature, the indicative potentials of the post-heating coil are expressed according to the outdoor air temperature

## EXFLOWC

### Application in spaces with forced air exhaust at variable flow and exhaust section

Option indicated for CCK-REVO configuration, for conditioning buildings with hoods or active air exhaust systems, for example catering kitchens, labs with suction hoods, where the fresh airflow is variable in function of the number of active extractors.

The option involves an electronic device installed built-in the unit that receives the activation status of the extractors on appropriate potential-free, through a single 4-20 mA signal or from a BMS signal. The amount of fresh air is modulated according to these inputs.

The unit is equipped with an exhaust fan section to allow air renewal even with the hoods off. The exhaust section is equipped with a plug-fan fan electronically controlled and managed by the unit logic according to the active suction hoods and the fresh air damper opening. To dimension the unit consider as max. exhaust airflow of the hoods the 50% of the nominal airflow. The air quality probe for controlling the rate of CO<sub>2</sub> / CO<sub>2</sub> and VOC, and the EXFLOWC can be simultaneously selected.

Where necessary, the unit will be integrated with further pre-heating options of which "Electrical heating resistance", "two-rows hot water coil" or "Gas heating module" to guarantee the operation of the unit with 50% of the fresh air in every operating situation, even at low outdoor air temperature.

- ⚠ The electronic device is installed and wired built-in the unit.
- ⚠ The option allows to manage up to 4 ON-OFF contacts from the exhaust devices or one 4-20 mA or via BMS signal (by Customer).
- ⚠ The connection cables for the 4-20 mA signal or the ON-OFF status do not require shielding.
- ⚠ The EXFLOWC option is not compatible with the 'PVARDP Variable air flow with pressure probe on the unit', 'SPVAR 0-10V signal for air flow modulation' and 'PPAQC External CO<sub>2</sub> signal management' options.
- ⚠ With minimum fresh air temperatures between 0°C and -8°C foresees the option "Electrical heating resistance" or "two-rows hot water coi" whereas for minimum temperatures between -8°C e -30°C foresees the "two-rows hot water coil" or "Gas heating module" option.

## EH

### Electric elements

This option is suggested for cold climates, allows the integration of heating capacity from the heat pump. The electrical heaters are placed before the treatment coil and perform the air preheating function, extending the operating range of the unit and helping quickly to reach the comfort in the room.

Ideal for climate areas in applications with low outside temperature where it is required to active the heaters only for short time in the year. In these cases the resulting system simplification (no water supply) compensates the energy costs.

The fins are made of aluminum, of suitable dimension to ensure high efficiency and maintain low power density on the surfaces to limit overheating. The low temperature of the heating elements increases the lifespan and limits the effect of air ionization.

### Matching of the electric elements

SIZE	60.4	70.4	80.4	90.4	100.4	120.4
<b>24 kW</b>	✓	✓	✓	✓	✓	✓
<b>36 kW</b>	✓	✓	✓	✓	✓	✓
<b>48 kW</b>	✓	✓	✓	✓	✓	✓

⚠ This operation involves variation of the main electrical data of the unit.

⚠ "Heating elements", "Condensig gas heating module with modulating control", "Energy recovery from food refrigeration" and "Two rows hot water coil" cannot be fitted at the same time.

### Operation field extension with electric heaters DT [°C]

SIZE	Portata aria [m <sup>3</sup> /h]	24 kW	36 kW	48 kW
<b>60.4</b>	33000	2,3	3,3	4,2
<b>70.4</b>	37000	2,1	3,0	3,8
<b>80.4</b>	44000	1,8	2,4	3,1
<b>90.4</b>	49000	1,6	2,1	3,2
<b>100.4</b>	53000	1,5	1,9	2,9
<b>120.4</b>	58000	1,3	1,7	2,6

The minimum operating temperature of the heat pump with electric heater change and depends on the series and the power of the electric heater. The minimum temperature is easily to reckon subtracting the DT value (previous table) to the entering internal exchanger air temperature TM(D.B.) for standard unit, at the desired conditions.



## CHW2

### Two-rows hot water coil

Option indicated for very cold climates, as it allows to heat up the area served. The exchanger comes with a thermostat for the antifreeze function, which is always active even when the unit is in stand-by, as long as it is operated electrically. If required, force the opening of the valve to the maximum value allowed to allow the air to pass through the exchanger and prevent frost from forming.

The hot water coil allows the integration of the heat pump capacity, as being placed before the treating coil, it pre-heats the air, extending the operation limits of the unit. If the water coil operates as integration to the heat pump, the control logic reduces the potential at a pre-determined limit value, which prevents to make the compressors work at too high condensation temperatures. On the other hand, if the water coil is used as main resource (i.e. availability of the compressors) the potential supplied will be the highest.

In the event laws or local standards encourage the use of the district heating, and so the use of hot water coil heating with the obligation to recover the energy contained inside the exhaust air flow, a turning point can be set, that is an outside air temperature, below which the unit uses the water coil as main resource and operates also as thermodynamic recuperator at very high efficiency, using the nominal capacity of the heat pump circuit only partially.

With the option is available a potential-free contact for the water circulator start-up (provided by the Installer).

### Hot water coil pressure drops: AIR side

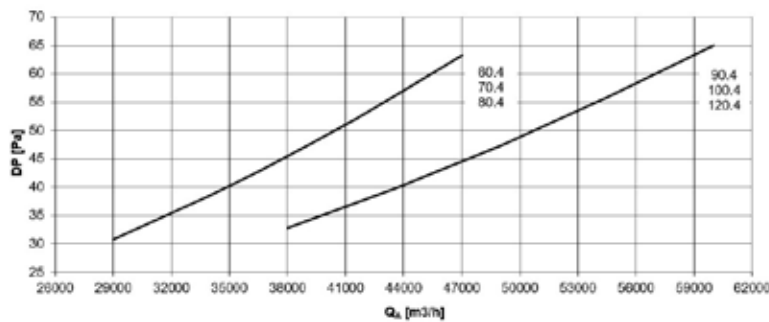

The air side pressure drops are relative to the medium air temperature of 20°C and are to be added to the pressure drops due to ducts, terminal devices and any other component that causes a drop in working discharge head.

QA [m³/h] = Airflow

DP [Pa] = Pressure drops

### Hot water coil pressure drops: WATER side

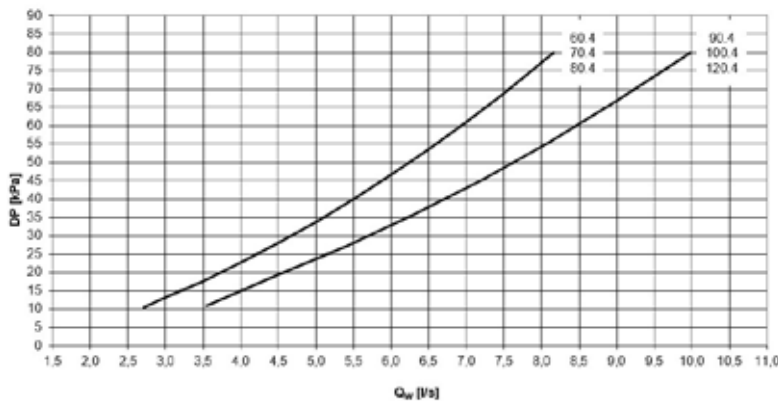

Pressure drops on the water side are calculated considering an average water temperature of 65°C

Qw [l/s] = Water flow-rate

DP = Pressure drops [kPa]

$$Q_w [l/s] = P / (4.186 \times DT)$$

P = Water coil heating capacity in KW

DT = Temperature difference between inlet / outlet water

This option reduces the available static pressure (supply air side).

⚠ The component requires connection to the hot water plumbing system (to be provided for by the client).

⚠ "2 range hot water coil", "Electric elements", "Condensig gas heating module with modulating control" and "energy recovery from food refrigeration" cannot be assembled simultaneously

## CHW2

### Two-rows hot water coil

		Ti/To [°C]												
		60/40	70/55	70/60	80/65	60/40	70/55	70/60	80/65	60/40	70/55	70/60	80/65	
		kWt	kWt	kWt	kWt	kWt	kWt	kWt	kWt	kWt	kWt	kWt	kWt	
60.4	Qo [m³/h]	29000				33000				47000				
	Qo [l/s]	8055				9167				13055				
	TM [°C]	-10	257,9	312,8	330,4	370,3	279,7	339,4	358,9	401,9	351,7	427,2	453,1	506,7
		-5	228,4	283,0	300,7	340,4	247,7	307,1	326,6	369,5	311,5	386,8	412,5	465,9
		0	205,1	259,7	277,0	316,7	222,3	281,7	301,0	343,8	279,6	354,7	380,3	433,6
		5	193,5	247,8	265,3	304,9	209,8	268,9	288,2	331,0	263,6	338,7	364,0	417,5
		10	182,0	236,4	253,8	293,2	197,2	256,4	275,7	318,3	247,6	322,8	348,1	401,4
		15	170,4	224,8	242,2	281,4	184,7	243,9	263,1	305,6	231,9	306,7	332,3	385,5
	70.4	Qo [m³/h]	29000				37000				47000			
		Qo [l/s]	8055				10278				13055			
TM [°C]		-10	257,9	312,8	330,4	370,3	300,5	364,8	386,2	432,3	351,7	427,2	453,1	506,7
		-5	228,4	283,0	300,7	340,4	266,2	330,2	351,5	397,4	311,5	386,8	412,5	465,9
		0	205,1	259,7	277,0	316,7	238,9	302,9	323,9	369,8	279,6	354,7	380,3	433,6
		5	193,5	247,8	265,3	304,9	225,4	289,1	310,1	356,0	263,6	338,7	364,0	417,5
		10	182,0	236,4	253,8	293,2	211,8	275,6	296,6	342,4	247,6	322,8	348,1	401,4
		15	170,4	224,8	242,2	281,4	198,3	262,1	283,1	328,7	231,9	306,7	332,3	385,5
80.4		Qo [m³/h]	29000				44000				47000			
		Qo [l/s]	8055				12222				13055			
	TM [°C]	-10	257,9	312,8	330,4	370,3	337,0	409,3	433,9	485,3	351,7	427,2	453,1	506,7
		-5	228,4	283,0	300,7	340,4	298,5	370,5	395,0	446,2	311,5	386,8	412,5	465,9
		0	205,1	259,7	277,0	316,7	267,9	339,8	364,1	415,3	279,6	354,7	380,3	433,6
		5	193,5	247,8	265,3	304,9	252,6	324,4	348,5	399,8	263,6	338,7	364,0	417,5
		10	182,0	236,4	253,8	293,2	237,3	309,2	333,3	384,4	247,6	322,8	348,1	401,4
		15	170,4	224,8	242,2	281,4	222,2	293,9	318,2	369,2	231,9	306,7	332,3	385,5
	90.4	Qo [m³/h]	38000				49000				60000			
		Qo [l/s]	10555				13611				16666			
TM [°C]		-10	337,3	412,6	434,6	487,8	398,0	487,4	514,4	576,9	452,2	554,3	585,8	656,5
		-5	298,9	373,9	395,6	448,6	352,7	441,7	468,5	530,6	400,6	502,4	533,6	603,9
		0	268,4	343,2	364,8	417,3	316,6	405,5	432,1	493,6	359,6	461,1	492,2	561,8
		5	253,3	327,9	349,6	402,0	298,5	387,4	414,0	475,4	339,2	440,6	471,6	541,2
		10	238,2	312,7	334,3	386,7	280,7	369,5	396,0	457,4	318,8	420,1	451,1	520,6
		15	223,1	297,6	319,2	371,4	262,9	351,5	378,0	439,3	298,3	399,7	430,7	500,1
100.4		Qo [m³/h]	38000				53000				60000			
		Qo [l/s]	10555				14722				16666			
	TM [°C]	-10	337,3	412,6	434,6	487,8	416,7	510,5	539,1	604,4	452,2	554,3	585,8	656,5
		-5	298,9	373,9	395,6	448,6	369,2	462,7	491,0	555,9	400,6	502,4	533,6	603,9
		0	268,4	343,2	364,8	417,3	331,4	424,7	452,9	517,2	359,6	461,1	492,2	561,8
		5	253,3	327,9	349,6	402,0	312,6	405,8	433,9	498,2	339,2	440,6	471,6	541,2
		10	238,2	312,7	334,3	386,7	293,9	387,0	415,0	479,2	318,8	420,1	451,1	520,6
		15	223,1	297,6	319,2	371,4	275,1	368,2	396,2	460,3	298,3	399,7	430,7	500,1
	120.4	Qo [m³/h]	38000				58000				60000			
		Qo [l/s]	10555				16111				16666			
TM [°C]		-10	337,3	412,6	434,6	487,8	442,8	542,7	573,5	642,7	452,2	554,3	585,8	656,5
		-5	298,9	373,9	395,6	448,6	392,3	491,9	522,4	591,2	400,6	502,4	533,6	603,9
		0	268,4	343,2	364,8	417,3	352,2	451,5	481,8	550,0	359,6	461,1	492,2	561,8
		5	253,3	327,9	349,6	402,0	332,1	431,4	461,6	529,8	339,2	440,6	471,6	541,2
		10	238,2	312,7	334,3	386,7	312,2	411,4	441,6	509,7	318,8	420,1	451,1	520,6
		15	223,1	297,6	319,2	371,4	292,2	391,4	421,6	489,6	298,3	399,7	430,7	500,1

TM = air inlet temperature of water coil (°C)

Ti/To = water inlet/outlet temperature (°C)

Qo = airflow (l/s and m³/h)

kWt = Provided heating capacity (kW)

Thermal yields referred to the max. water coil capacity. The thermo regulator chokes the 3-way modulating valve limiting the inlet air temperature at desired values.

# Accessories

2WVM  
3WVM

## Modulating 2-way valve

## Modulating 3-way valve

To be combined with hot water coil (optional). It is managed by the built-in microprocessor via a 0-10V signal and allows the fully automatic control of the water coil. The valve with modulating actuator is provided already assembled and wired built-in the unit.

### Valve pressure drops

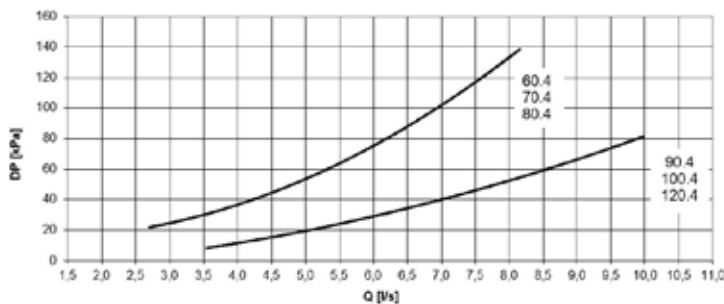

Q [l/s] = water flow-rate  
DP [kPa] = pressure drops

⚠ This accessory has to be coupled to the "CHW2 - Two-row hot water coil" option

3WVM

## Modulating 3-way valve for energy recovery from food refrigeration

To be combined with water coil for the energy recovery from food refrigeration. It is managed by the built-in microprocessor via a 0-10V signal and allows the fully automatic control of the water coil. The valve with modulating actuator is provided already assembled and wired built-in the unit.

### Valve pressure drops

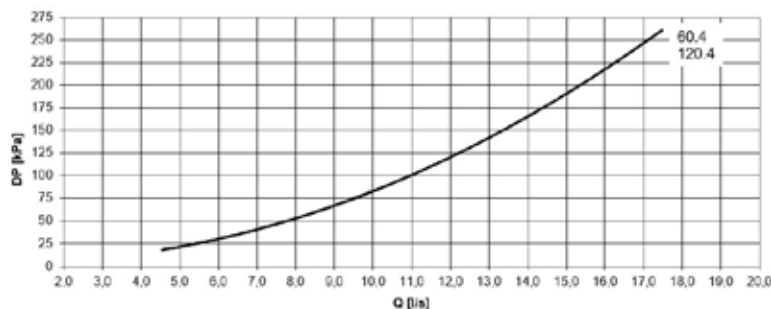

Q [l/s] = water flow-rate  
DP [kPa] = pressure drops

⚠ This accessory has to be coupled to the "CHWER - Energy recovery from food refrigeration" option.

SPVAR

## 0-10 V signal for air flow modulation

Option to control the supply and exhaust air flow via a single external 0-10V signal. A suitable solution in systems serving several rooms with a similar heat load profile, but separated from each other and occupied in a discontinuous way.

In periods of domestic hot water emergency, it is suitable for managing a lower air flow than the nominal one, as well as keeping the system on at night, thereby ensuring that internal pollutants are continuously diluted. The air flow can vary linearly according to the signal received between two air flow levels set in the unit selected within the admissible air flow range for the selected model (values shown in the fans section).

⚠ The SPVAR option is not compatible with the 'PCOSM Constant supply air flow' and 'PVAR Variable air flow' options

## HSE Immersed electrodes steam humidifier

This device is suitable for winter operation when humidity is required for the ambient without cooling the air flow. The automatic modulating control allows you to adjust the steam production and its relative management costs to the actual requirements.

Available in different capacities, the device is suitable for using soft water having medium conductivity and is equipped with: water load solenoid valve, disposable cylinder, water drainage solenoid valve, distribution nozzle, control electronic board to verify the water level, conductivity, anti-foam device, water drainage manual forcing. To ensure maximum hygiene, the cylinder can automatically empty after a determined period of stand-by.

The accessory is installed inside the unit and is connected to the electrical panel of the unit.

Ambient humidity is measured by means of a return humidity probe, which is provided already assembled and wired built-in the unit.

With the option is available a potential-free contact for the water emptying during the period in which the unit is not used (connection provided by the Customer).



### Matching of immersed electrode and steam humidification module

SIZE	60.4	70.4	80.4	90.4	100.4	120.4
8 kg/h	✓	✓	✓	✓	✓	✓
15 kg/h	✓	✓	✓	✓	✓	✓

⚠ This operation involves variation of the main electrical data of the unit.

⚠ This accessory requires connection to a water supply network and discharge water circuit. Installation provided by the Customer.

⚠ Operation is available in heating mode

## PUE External Humidifier management with 0-10V signal

Solution suitable for applications where there is a humidification section external supplied by a third party. The external humidifier is operated with the 0-10V signal coming from the unit.

## PCMO Sandwich panels of the handling zone in M0 fire reaction class

Option indicated when, by law, the air treatment area must have metallic internal walls made with fire-proof insulating material. Sandwich panels with dual walls made of steel sheet metal with fire-proof insulation made of Rockwool (90 kg/m<sup>3</sup>) comply with the French standards, which require "M0" reaction to fire class.

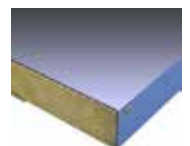

## LTEMP1 Application for low outdoor temperature

Option indicated for very cold climates, where the outside temperature can be between -10°C and -25°C.

- The option includes self-regulating heaters with thermostats that can protect the electrical panel from freezing to make sure it operates correctly.
- The outdoor air damper is made of anti-seize devices that ease the correct control of the fresh air in every climatic situation, thanks to the teflon supporting bushings, aluminium flaps, PVC end gaskets and steel leverages to compensate expansion
- The motorised actuator is suitable for operating with low outdoor temperatures.
- Electrical connection cables suitable for outdoor low temperatures



⚠ This operation involves variation of the main electrical data of the unit.

⚠ This accessory operates even when the unit is switched off provided that the power supply is maintained active and the unit continues to be connected.

⚠ It is necessary to make precautions against build up of snow and ice in front of the exhaust and outdoor air inlet locations.

## CHWER Energy recovery from food refrigeration

This option makes it possible, during the winter season, to recover the heating energy produced by food storage in supermarkets, hypermarkets or food factories. It is a technical solution that recovers a significant heating resource, which is otherwise normally released outdoors.

The unit logic assigns a priority value to this function based on the heating availability of the resource, and integrates the overall output of the unit.

The option is comprised of a water exchanger, which is automatically controlled by a dedicated valve. With electrically powered units, the frost function is enabled, which forces the valve open when required.

### Hot water coil pressure drops: AIR side

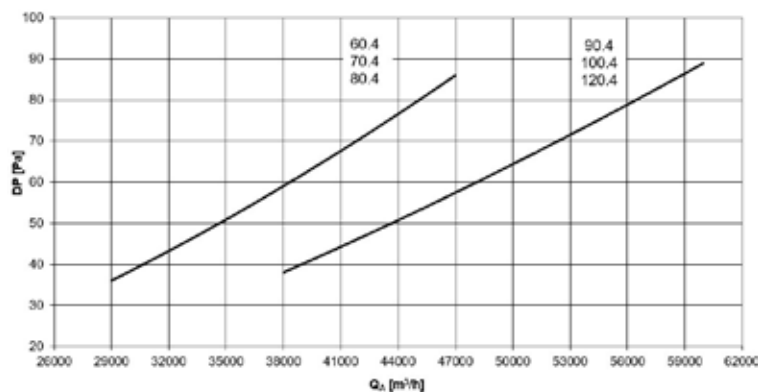

The air side pressure drops are relative to the medium air temperature of 20°C and are to be added to the pressure drops due to ducts, terminal devices and any other component that causes a drop in working discharge head.

QA [m³/h] = Airflow  
DP [Pa] = Pressure drops

### Hot water coil pressure drops: WATER side

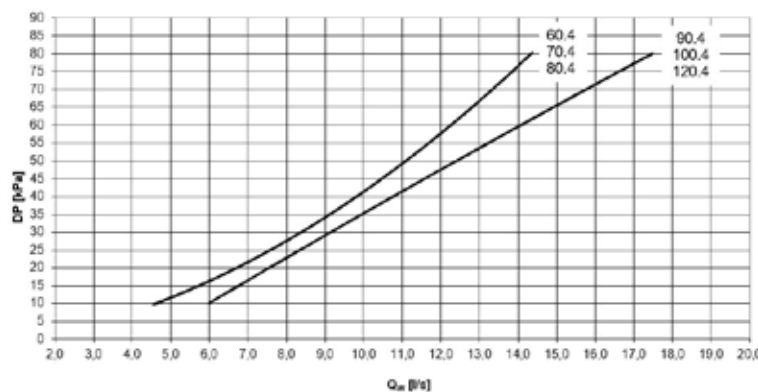

Pressure drops on the water side are calculated considering an average water temperature of 65°C

Qw [l/s] = Water flow-rate  
DP [kPa] = Pressure drops

$$Qw [l/s] = P / (4.186 \times DT)$$

P = Water coil heating capacity in KW  
DT = Temperature difference between inlet / outlet water

This option reduces the available static pressure (supply air side).

- ⚠ The component requires connection to the hot water plumbing system (to be provided for by the client).
- ⚠ "2 range hot water coil", "Electric heaters", "Gas heating module" and "Energy recovery from food refrigeration" cannot be fitted at the same time.

## CHWER Energy recovery from food refrigeration

		Ti/To [°C]									
		45/40	40/35	35/30	45/40	40/35	35/30	45/40	40/35	35/30	
		kWt	kWt	kWt	kWt	kWt	kWt	kWt	kWt	kWt	
60.4	Qo [m³/h]	29000			33000			47000			
	Qo [l/s]	8055			9167			13055			
	TM [°C]	5	265,1	228,9	192,5	290,2	250,5	210,6	373,9	322,5	270,7
		10	227,5	191,6	155,6	249,1	209,7	170,1	321,2	269,9	218,5
		14	198,0	162,2	126,5	216,8	177,5	138,2	279,3	228,3	177,3
		16	183,3	147,7	112,0	200,7	161,5	122,4	258,6	207,7	156,8
		18	168,8	133,2	97,6	184,8	145,7	106,6	237,9	187,1	136,4
		20	154,8	118,9	83,3	169,2	130,0	90,9	217,4	166,8	116,0
	70.4	Qo [m³/h]	29000			37000			47000		
		Qo [l/s]	8055			10278			13055		
TM [°C]		5	265,1	228,9	192,5	314,4	271,3	228,0	373,9	322,5	270,7
		10	227,5	191,6	155,6	269,9	227,1	184,1	321,2	269,9	218,5
		14	198,0	162,2	126,5	234,9	192,2	149,5	279,3	228,3	177,3
		16	183,3	147,7	112,0	217,4	174,9	132,3	258,6	207,7	156,8
		18	168,8	133,2	97,6	200,1	157,7	115,2	237,9	187,1	136,4
		20	154,8	118,9	83,3	183,1	140,6	98,2	217,4	166,8	116,0
80.4		Qo [m³/h]	29000			44000			47000		
		Qo [l/s]	8055			12222			13055		
	TM [°C]	5	265,1	228,9	192,5	356,7	307,7	258,4	373,9	322,5	270,7
		10	227,5	191,6	155,6	306,4	257,5	208,6	321,2	269,9	218,5
		14	198,0	162,2	126,5	266,5	217,9	169,3	279,3	228,3	177,3
		16	183,3	147,7	112,0	246,7	198,2	149,7	258,6	207,7	156,8
		18	168,8	133,2	97,6	227,0	178,6	130,3	237,9	187,1	136,4
		20	154,8	118,9	83,3	207,4	159,2	110,9	217,4	166,8	116,0
	90.4	Qo [m³/h]	38000			49000			60000		
		Qo [l/s]	10555			13611			16666		
TM [°C]		5	348,3	301,1	253,7	418,8	361,7	304,5	482,6	416,5	350,6
		10	299,3	252,4	205,4	359,8	303,2	246,4	414,7	349,3	283,5
		14	260,6	214,0	167,2	313,3	257,0	200,5	361,0	295,9	230,5
		16	241,5	195,0	148,3	290,2	234,1	177,6	334,6	269,4	204,2
		18	222,5	176,0	129,5	267,4	211,2	155,0	308,1	243,1	177,9
		20	203,5	157,2	110,7	244,5	188,5	132,3	281,7	216,9	151,8
100.4		Qo [m³/h]	38000			53000			60000		
		Qo [l/s]	10555			14722			16666		
	TM [°C]	5	348,3	301,1	253,7	441,0	380,7	320,6	482,6	416,5	350,6
		10	299,3	252,4	205,4	378,9	319,3	259,3	414,7	349,3	283,5
		14	260,6	214,0	167,2	329,9	270,5	210,9	361,0	295,9	230,5
		16	241,5	195,0	148,3	305,7	246,4	186,9	334,6	269,4	204,2
		18	222,5	176,0	129,5	281,6	222,3	162,9	308,1	243,1	177,9
		20	203,5	157,2	110,7	257,5	198,4	139,1	281,7	216,9	151,8
	120.4	Qo [m³/h]	38000			58000			60000		
		Qo [l/s]	10555			16111			16666		
TM [°C]		5	348,3	301,1	253,7	471,5	407,0	342,6	482,6	416,5	350,6
		10	299,3	252,4	205,4	405,1	341,3	277,1	414,7	349,3	283,5
		14	260,6	214,0	167,2	352,7	289,1	225,3	361,0	295,9	230,5
		16	241,5	195,0	148,3	326,9	263,3	199,6	334,6	269,4	204,2
		18	222,5	176,0	129,5	301,0	237,6	173,9	308,1	243,1	177,9
		20	203,5	157,2	110,7	275,2	212,0	148,4	281,7	216,9	151,8

TM = air inlet temperature of water coil (°C)

Ti/To = water inlet/outlet temperature (°C)

Qo = airflow (l/s and m³/h)

kWt = Provided heating capacity (kW)

Thermal yields referred to the max. water coil capacity. The thermo regulator chokes the 3-way modulating valve limiting the inlet air temperature at desired values.

# Accessories

## DESM

### Smoke detector

This option allows detection of smoke in the room by analyzing the return air. The Tyndal-effect increased sensitivity smoke detector is perfect for ventilation ducts since it is able to detect rarefied smoke in high-speed air flows. Smoke detection occurs using a photo-optical system with a labyrinth chamber. The alarm signal is processed by a built-in micro-processor which verifies the condition and sends a message to the unit controller such as smoke alarm or failure. The device is installed inside the unit and it is made up of a sensor, installed inside the return piping, and of a controller that is located on the outside duct.



### Control logics in the event of alarm signal

#### COMPLETE UNIT SHUTDOWN

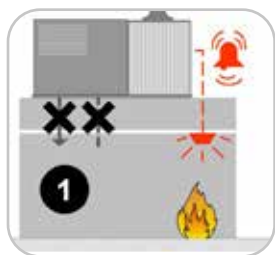

#### SPACE IN OVERPRESSURE

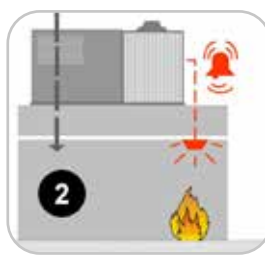

#### SPACE IN UNDER PRESSURE

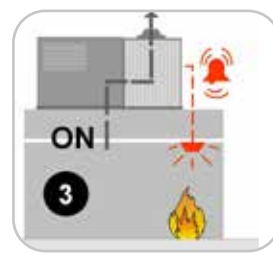

The unit is able to manage the signal coming from a fire detection system activating one of the logics illustrated, which can be set by parameters. In presence of alarm signal, the compressors are always switched off; moreover, the remote ON-OFF is disabled together with the switch on/off control from keypad. The unit is manually reset. Rooftop units cannot be used as fume extractor.

⚠ Any fire detection devices built-in the unit must be considered as an auxiliary safety system, and, accordingly, must not be a replacement for any fire detection devices in the room.

## CCCA

### Copper / aluminium coil with acrylic lining

Coils with copper pipes and aluminium fins with acrylic lacquering. Can be used in settings with air with low saline concentrations or other moderately aggressive chemical agents. Attention!

- Cooling capacity variation -2.7%.
- Compressor power input variation +4.2%.
- Operating range reduction -2.1°C.

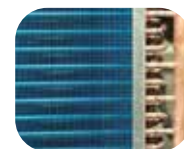

- ⚠ Configurable coating for all the coils of the refrigerant circuit (Handling, Source, Hot gas post-heating - CPHG).
- ⚠ Water coil treatment (CHW2 and CHWER) available on request

## CCCA1

### Copper/aluminum coil with Fin Guard (Silver) treatment

A treatment which offers an optimal thermal exchange and guarantees and protects the finned coil exchangers from corrosion over time. Can be used in settings with very aggressive saline concentrations and other chemical agents in the air thus maintaining the performance of the coils over time.



- ⚠ Option available on request.

## CCCC

### Copper / copper coil

Coils with copper pipes, copper fins and brass structure. Can be used in settings with air with low saline concentrations or other chemical agents. The options are available for:

- external coil;
- internal coil;
- hot water coil;
- re-heating coil.



- ⚠ This option is not suitable for application in sulphuric environments.
- ⚠ Option available on request.

## CLMX

### Clivet Master System

CLIVET MASTER SYSTEM is the ideal system for remote and centralised control of CLIVETPack<sup>3</sup> and SMARTPack<sup>2</sup> air conditioning units. It can manage up to 10 units connected with a serial connection. It includes a wall-mounted box that, in addition to containing the electronic power supply and serial communication devices, houses a controller with touch screen display and front USB port for alarm history export.

The device allows to easily and intuitively access all the information on the status of the system and the climate control units. It also provides:

- auto-detection of units connected;
- setting all unit parameters;
- setting of the zone set-point;
- unit status display;
- control and management of the alarms and creation of an alarm log;
- hourly operation scheduling (ON / OFF / ECO);
- rotation of the units even for individual areas;
- temperature, humidity and air quality trends;
- automatic language management (English, Italian, French, Spanish and German).

- ⚠ The component must be combined with the RS485 serial port option with Modbus protocol built-in of each rooftop.
- ⚠ Operating temperature from 0°C to 50°C with relative humidity lower than 90% without condensate.
- ⚠ Installation provided by the Customer.



## IOTX

### IoT industrial module for cloud based interoperability & services

This device allows the monitoring and the remote control the unit via Clivet Eye, the supervision cloud system for Clivet units.

With IoT module (i-LINK) it will be possible to monitor and manage the unit through the mobile app Clivet Eye and the dedicated web page.

Among the main functions, for all monitored units they allow to:

- display the main working parameters;
- display the alarms;
- switch on/off the unit;
- change the setpoint;
- change the operating mode;
- set the daily/weekly start-up or power-off programming of the unit;
- create charts of main system parameters trend (via web interface);
- display in a map the units monitored by Clivet Eye (via web interface).

Web interface at [www.cliveteye.com](http://www.cliveteye.com).

Clivet Eye app available in Google Play and Apple Store

- ⚠ IoT module to be provided for each unit to be remotely monitored.
- ⚠ Internet ethernet connection in charge of customer.
- ⚠ Clivet Eye management is alternative to an external BMS supervision system.
- ⚠ Installation provided by the Customer.



## SIX

### Service interface (1.5 metre cable)

The device allows full control of the unit for start-up and maintenance operations by authorised technical personnel. It must be connected to the outside of the unit via the RJ45 connector and the 1.5m connection cable that can be further extended. The device can be easily attached to the unit's surface by the magnetic mount. It is weatherproof thanks to the IP68 protection rating. The controller has a backlit screen, convenient buttons, a graphic interface with menus and submenus for navigation.

- ⚠ All the features of the device can be replicated with a normal laptop connected to the unit with an Ethernet network cable and an Internet browser.



# Accessories separately supplied

**AMRX**  
**AMMRX**  
**AMRUVX**  
**AMREWXX**

## Rubber antivibration mounts

**la**Rubber antivibration mounts for unit and gas module

**Rubber antivibration mounts for unit and UV-C lamp module**

**Rubber antivibration mounts for unit and enthalpy wheel module**

The rubber antivibration mounts must be fixed to designated housings on the support stringers and are used to dampen vibrations produced by the unit, thereby reducing the noise transmitted to the support structures. They are flexible bodies able to dampen axial and tangential stresses and maintain the mechanical properties almost constant over time thanks to high resistance materials of which they are made.

Alternatively, rubberized neoprene anti-vibration strips may be used on the unit longitudinal support members (not supplied by Clivet).



⚠ Installation provided by the Customer.

**RCX**

## Roof curb

Option to connect the unit to the roof of the building, ideal when the air supply and return is downward.

Once the frame is assembled, it will be necessary to insulate and seal the roof curb to the roof to guarantee the resistance to atmospheric agents, later it will be necessary only to place the unit.

⚠ If the gas module is selected, provide for an appropriate support structure, the supply air can only be horizontal.

⚠ Option available on request.

**UVCX**

## UV-C germicidal lamps module

The UV-C lamp module is a well-established technology in HVAC applications and it is realized to be effective on viruses such as SARS-CoV-2 and main bacteria such as Legionella, etc.

UV-C lamps use ultraviolet radiation to purify the air from the development of bacteria, moulds, fungi and viruses. Recent Italian and Japanese studies have demonstrated the effectiveness on Coronavirus SARS CoV2 (known as Covid-19) by defining the dose of UV-C rays required to deactivate it.

The bactericidal and virucidal action is achieved with low pressure mercury lamps through the direct radiation of the air flow with a wavelength of 254 nm.

In rooftop systems, UV-C lamps are installed downstream of the handling coil and act directly in the air flow.

The option is installed in a separate module, outside the unit, with a dedicated electrical panel and separate power supply. It is activated by the unit's logic when the supply fans are running.

The radiation is completely contained and shielded inside the unit to avoid accidental contact with people; in fact, exposure to the rays without the necessary safety devices can cause skin burns and damage vision.

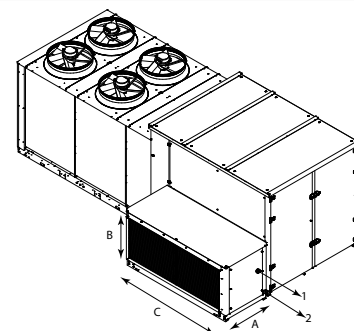

1. Isolator switch
2. Power input

SIZES		60.4	70.4	80.4	90.4	100.4	120.4
<b>A</b>	mm	1095	1095	1095	1095	1095	1095
<b>B</b>	mm	1206	1206	1206	1204	1204	1204
<b>C</b>	mm	2508	2508	2508	3096	3096	3096
<b>F.L.A.</b>	A	2,65	2,65	2,65	3,95	3,95	3,95
<b>F.L.I.</b>	kW	600	600	600	900	900	900

⚠ The component requires a 230/1 ~ / 50 power supply to be provided by the customer.

⚠ Installation provided by the Customer.

## MDMTX Management of temperature ambient probes

By selecting this option it is possible to provide from 1 to 4 remote room temperature probes. The values recorded by the probes can be consulted on the remote control and with the available supervision systems.

The average of the values recorded by the probes can be used for thermoregulation.

- ⚠ Place the probes in a position that represents the conditions of the environment served.
- ⚠ To thermoregulate with remote probes, at least three MDMTX probes must be selected.



## MDMTUX Management of temperature and humidity ambient probes

By selecting this option it is possible to provide from 1 to 4 remote room temperature and humidity probes. The values recorded by the probes can be consulted on the remote control and with the available supervision systems.

The average of the values recorded by the probes can be used for thermoregulation.

- ⚠ Place the probes in a position that represents the conditions of the environment served.
- ⚠ To thermoregulate with remote probes, at least three MDMTUX probes must be selected.

## MDMADX Advanced monitoring and management ambient probes

Selecting this option provides the advanced ambient condition monitoring system with a designer ambient interface. The remote probes are able to measure many parameters and provide a full picture of ambient conditions in terms of:

- Temperature and humidity
- Concentration of Carbon Dioxide (CO<sub>2</sub>)
- Concentration of Volatile Organic Compounds (VOC)
- Concentration of Carbon Monoxide (CO)
- Concentration of Nitrogen Dioxide (NO<sub>2</sub>)
- Concentration of Methane (CH<sub>4</sub>)
- Sound level
- Atmospheric pressure

The parameters are recorded by the software and can be consulted via BMS or the Clivet Eye platform for PCs. Using the latter, in addition to accessing to each probe in detail, it is possible to visualize the trend of the recorded data of the last month and export the data of the 24 hours before a selected day.

The advanced monitoring devices comply with the requirements of LEED, WELL and Fitwell certifications.

The average of the values recorded by the probes (temperature and humidity) can be used for thermoregulation.

- ⚠ Place the probes in a position that represents the conditions of the environment served.
- ⚠ To thermoregulate with remote probes, at least three MDMADX probes must be selected.



# Accessories separately supplied

## EWX

### Enthalpy wheel energy recovery module

Thanks to the hygroscopic treatment of the exchange surface, the enthalpy wheel allows the efficient transfer of sensitive and latent heat from the exhausted air extracted from the building to the fresh air and vice versa.

Option suitable for applications with high percentages of outdoor air and considerable difference between outdoor and indoor temperature conditions.

The fixed-speed rotary recuperator combines a high exchange surface with overall compactness of the module.

The recovery of latent and sensitive energy is greater under extreme conditions, reducing the capacity required for the refrigeration circuit and any auxiliary systems.

During free-cooling operation the enthalpy wheel is automatically turned off.

The option is provided with a separate module that can be easily connected to the unit during installation.

The enthalpy wheel energy recovery module comprises:

- Enthalpy wheel
- Extraction fans (RAD/EC)
- ISO 16890 Coarse 50% filters (G4) upstream of the rotor for both flows
- Control and safety devices

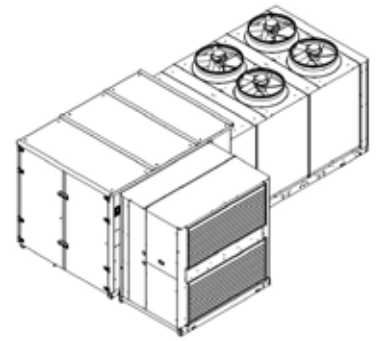

Option compatible with available thermal integration systems

⚠ This option is only compatible with the return section in position R3 (Downward air return) and CBK-G configuration.

⚠ This option involves variation of the main electrical data of the unit.

⚠ This option reduces the available static pressure (supply air side).

### Enthalpy wheel combinations

	60.4	70.4	80.4	90.4	100.4	120.4
<b>EW18X</b>	✓	✓	-	-	-	-
<b>EW20X</b>	-	-	✓	✓	-	-
<b>EW22X</b>	-	-	-	-	✓	✓

			60.4	70.4	80.4	90.4	100.4	120.4	
Airflow rate		m <sup>3</sup> /h	9900	11100	13200	14700	15900	17400	
Wheel diameter		mm	1800	1800	2000	2000	2200	2200	
Cooling	Recovered power	kW	1	34,9	38	45,9	49,5	55	58,6
	Efficiency	%	1	71,1	69,7	70,4	69,0	70,1	69,0
Heating	Recovered power	kW	2	32,4	35,7	42,8	46,9	51,4	55,4
	Efficiency	%	2	73,4	72,1	72,8	71,5	72,5	71,5
	Recovered power	kW	3	86,4	94,9	114,0	124,4	136,9	147,2
	Efficiency	%	3	73,4	72,1	72,8	71,5	72,5	71,5

Flow rate corresponding to 30% of the nominal air flow rate.

(1) Outdoor temperature 35°C DB/24°C WB, indoor temperature 27°C DB/19°C WB

(2) Outdoor temperature 7°C DB/6°C WB, indoor temperature 20°C DB/12°C WB

(3) Outdoor temperature -7°C DB/-8°C WB, indoor temperature 20°C DB/12°C WB

## GCX

### Condensing gas heating module with modulating control

Option consisting of a combustion chamber and condensation burner with modulating control. It is available in various capacities and heats the environment served. The module can be chosen to integrate the heat pump or as an alternative to it. In this case, its heating capacity must be at least equal to the capacity envisioned in the project.

Thanks to the condensation technology with pre-mix and extremely efficient modulation (up to 105% depending on the lower heat value), consumption is very contained and considerably reduced during operation at partial load. The burner with low polluting emissions (NO<sub>x</sub> lower than 80mg/kWh) in accordance with Class 5 of European standard EN 676.

The option is provided with a separate module that can be easily connected to the unit during installation.

The gas module presence needs the horizontal supply.

The heating module includes:

- hot air generator with condensation and integrated modulating adjustment, powered with methane gas
- kit for transformation of power with liquefied petroleum gas (LPG)
- kit of steel chimney for exhaust fumes
- all the control and safety devices

### Gas connection diagram

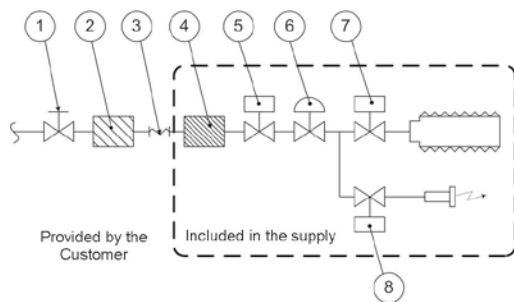

1. Gas shut-off valve
2. Gas filter (large section)
3. Anti-vibration joint
4. Gas filter (small section)
5. Safety gas solenoid valve
6. Pressure stabiliser
7. Main gas burner solenoid valve
8. Pilot burner gas solenoid valve

### Matching of the condensing gas heating module

	Capacity	60.4	70.4	80.4	90.4	100.4	120.4
GC10X	82 kW	✓	✓	✓	-	-	-
GC11X	100 kW	✓	✓	✓	-	-	-
GC12X	130 kW	-	-	-	✓	✓	✓
GC13X	164 kW	✓	✓	✓	✓	✓	✓
GC06X	200 kW	✓	✓	✓	✓	✓	✓
GC07X	300 kW	-	-	-	✓	✓	✓

This option reduces the available static pressure (supply air side).

⚠ The component requires gas supply (gas connections to be made by the Customer). The location of the unit and the fume drain mode must comply with laws and standards in force in the Country of use.

⚠ The assembly of the chimney kit must be performed on site by the Customer. According to specific requirements of installation, the chimney length can be increased by means of appropriate joints and fittings (not supplied by Clivet). For further details, refer to the Installation, use and maintenance manual.

⚠ "2 range hot water coil", "Electric heaters", "Gas heating module" and "Energy recovery from food refrigeration" cannot be fitted at the same time.

### Gas use features

Description		82KW		100KW		130KW		164KW		200KW		300KW	
		min	max	min	max	min	max	min	max	min	max	min	max
Rated heating capacity	kW	16,4	82,0	21,0	100,0	12,4	130,0	16,4	164,0	21,0	200,0	21,0	300,0
Efficiency Hi (P.C.I.)	%	108,4	97,6	108,6	97,2	108,1	96,8	108,4	97,6	108,6	97,2	108,6	97,2
Efficiency Hs (P.C.S.)	%	97,6	87,9	97,8	87,5	97,4	87,2	97,6	87,9	97,8	87,5	97,8	87,5
Max condensation produced	l/h	3,3		2,7		4,2		6,6		5,4		8,1	
Carbon monoxide CO (0% di O <sub>2</sub> )	ppm	<5		<5		<5		<5		<5		<5	
Nitrogen oxides - NO <sub>x</sub> (0% di O <sub>2</sub> )		41 mg / kWh 23 ppm		39 mg / kWh 22 ppm		39 mg / kWh 23 ppm		41 mg / kWh 23 ppm		39 mg / kWh 22 ppm		39 mg / kWh 22 ppm	
Available flue pressure	Pa	120		120		120		120		120		120	
Gas connection diameter	GAS	UNI ISO 228/1 - G 3/4"		UNI ISO 228/1 - G 3/4"		UNI ISO 228/1 - G 1/2"		UNI ISO 228/1 - G 1/2"		UNI ISO 228/1 - G 1/2"		UNI ISO 228/1 - 1xG 1 1/4" and 1xG3/4"	
Flue pipe diameter	mm	80		80		2 x 80		2 x 80		2 x 80		3 x 80	
Seasonal space heating energy efficiency [EU Reg./2281/2016] [η <sub>sp</sub> , h]	%	93,2		93,1		93,9		94,0		94,0		94,2	
Emission efficiency [EU Reg./2281/2016] [η <sub>sp</sub> flow]	%	97,1		97,0		98,1		97,9		97,9		98,1	
Power supply pressure (for gas G20)	mbar	20 [min 17 -max 25]											
Gas consumption @15°C - 1013 mbar (for G20 gas)	m <sup>3</sup> /h	1,74	8,68	2,22	10,58	2,62	13,76	3,48	17,36	4,44	21,16	6,66	31,74

# Performance

The performance data of all configurations are available on [www.clivet.com](http://www.clivet.com).

## Size 60.4 - CCK-REVO configuration

### Cooling performance with 30% of outdoor and exhaust air

FLOW RATE AIR	Ta [°C] DB/WB	Outdoor temperature [°C] DB/WB														
		20/12			25/18			30/22			35/24			40/25		
		kWf	kWs	EER	kWf	kWs	EER	kWf	kWs	EER	kWf	kWs	EER	kWf	kWs	EER
29000 m³/h	20/15	186	135	5,57	191	129	5,07	193	127	4,60	190	131	4,07	184	136	3,56
	23/17	195	140	5,80	199	135	5,24	200	134	4,72	197	137	4,17	191	143	3,66
	26/18	199	152	5,89	203	147	5,33	204	146	4,79	201	149	4,24	195	155	3,72
	27/19	203	151	5,99	207	147	5,40	208	146	4,86	205	149	4,31	198	155	3,76
	30/22	218	149	6,37	221	145	5,70	221	145	5,08	217	149	4,48	210	155	3,92
33000 m³/h	20/15	191	142	5,70	196	136	5,19	197	134	4,66	194	138	4,13	188	145	3,62
	23/17	200	148	5,92	204	143	5,34	205	141	4,81	201	145	4,24	195	152	3,72
	26/18	204	161	6,02	208	156	5,43	209	155	4,88	205	159	4,30	199	166	3,78
	27/19	209	160	6,15	212	155	5,51	213	154	4,94	209	159	4,36	202	166	3,81
	30/22	223	157	6,48	226	154	5,79	226	154	5,17	221	159	4,54	214	166	3,97
47000 m³/h	20/15	202	164	5,96	207	156	5,40	208	154	4,86	204	160	4,29	197	169	3,75
	23/17	212	172	6,22	215	165	5,57	216	164	5,00	211	171	4,40	204	181	3,84
	26/18	216	189	6,32	219	183	5,66	220	183	5,07	215	189	4,45	208	200	3,90
	27/19	221	188	6,44	224	183	5,76	224	183	5,14	219	190	4,52	212	200	3,95
	30/22	235	185	6,77	238	181	6,04	237	182	5,36	232	190	4,71	223	201	4,08

Ta = Indoor air temperature D.B/W.B

DB = Dry bulb

WB = Wet bulb

kWf = Cooling capacity in kW

kWs = Sensible cooling capacity (kW)

EER referred only to compressors

All cooling and thermal capacities do not take into account the heat dissipated by the fan motors

## Size 60.4 - CCK-REVO configuration

### Heating performance with 30% of outdoor and exhaust air

FLOW RATE AIR	Ta [°C] DB	Outdoor temperature [°C] DB/WB													
		-15/-16		-10/-11		-5/-6		0/1		2/1		7/6		12/11	
		kWt	COP	kWt	COP	kWt	COP	kWt	COP	kWt	COP	kWt	COP	kWt	COP
29000 m³/h	10	112	4,52	127	4,57	146	4,69	146	4,69	176	4,88	200	4,99	200	4,99
	15	111	4,17	127	4,26	146	4,40	146	4,40	176	4,56	199	4,64	199	4,64
	18	111	4,01	127	4,10	146	4,22	146	4,22	175	4,36	198	4,45	198	4,45
	20	111	3,89	127	3,99	146	4,11	146	4,11	175	4,26	198	4,33	198	4,33
	22	111	3,79	127	3,88	146	4,00	146	4,00	175	4,15	197	4,20	197	4,20
	25	111	3,63	127	3,72	145	3,83	145	3,83	145	3,83	145	3,83	145	3,83
33000 m³/h	10	112	4,65	127	4,72	147	4,92	147	4,92	177	5,13	201	5,28	201	5,28
	15	111	4,30	127	4,41	146	4,56	146	4,56	176	4,77	200	4,90	200	4,90
	18	111	4,13	127	4,23	146	4,38	146	4,38	176	4,60	199	4,69	199	4,69
	20	111	4,02	127	4,12	146	4,27	146	4,27	175	4,45	199	4,57	199	4,57
	22	111	3,91	127	4,02	146	4,16	146	4,16	175	4,33	198	4,44	198	4,44
	25	111	3,75	127	3,86	146	4,01	146	4,01	146	4,01	146	4,01	146	4,01
47000 m³/h	10	112	5,00	128	5,14	147	5,36	147	5,36	178	5,74	203	6,01	203	6,01
	15	112	4,65	127	4,76	147	5,00	147	5,00	177	5,32	202	5,56	202	5,56
	18	111	4,42	127	4,57	146	4,77	146	4,77	177	5,12	201	5,32	201	5,32
	20	111	4,30	127	4,46	146	4,65	146	4,65	176	4,94	201	5,18	201	5,18
	22	111	4,19	127	4,33	146	4,53	146	4,53	176	4,82	200	5,01	200	5,01
	25	111	4,02	127	4,16	146	4,36	146	4,36	146	4,36	146	4,36	146	4,36

Ta = Indoor ambient temperature DB/WB

DB = Dry bulb

kWt = Heating capacity supplied (kW)

COP referred to compressors only

## Size 70.4 - CCK-REVO configuration

### Cooling performance with 30% of outdoor and exhaust air

AIR FLOW	Ta[°C] DB/ WB	Outdoor temperature [°C] DB/WB														
		20/12			25/18			30/22			35/24			40/25		
		kWf	kWs	EER	kWf	kWs	EER	kWf	kWs	EER	kWf	kWs	EER	kWf	kWs	EER
29000 m³/h	20/15	205	146	5,53	210	140	5,00	212	138	4,53	209	141	4,02	202	146	3,51
	23/17	214	151	5,69	219	146	5,15	220	144	4,64	217	147	4,12	210	153	3,61
	26/18	218	163	5,77	223	158	5,22	225	156	4,72	221	160	4,17	214	165	3,65
	27/19	223	162	5,85	228	158	5,30	229	156	4,77	225	160	4,22	218	165	3,70
	30/22	239	160	6,16	243	156	5,55	243	155	4,97	239	159	4,39	231	165	3,84
37000 m³/h	20/15	215	161	5,70	220	153	5,16	222	151	4,67	218	155	4,14	211	163	3,62
	23/17	225	167	5,91	229	161	5,31	230	159	4,79	226	164	4,23	219	171	3,71
	26/18	229	181	5,98	234	175	5,40	234	174	4,84	230	179	4,28	223	186	3,76
	27/19	234	180	6,06	238	175	5,46	239	174	4,92	234	179	4,33	227	186	3,80
	30/22	250	177	6,36	254	173	5,71	253	173	5,10	248	178	4,50	240	187	3,94
47000 m³/h	20/15	224	177	5,88	229	168	5,31	230	166	4,79	225	172	4,22	218	182	3,70
	23/17	234	184	6,08	238	177	5,46	238	176	4,90	234	182	4,33	226	192	3,79
	26/18	239	202	6,16	243	195	5,55	243	194	4,97	238	201	4,38	230	211	3,83
	27/19	244	201	6,26	247	195	5,60	247	194	5,02	242	201	4,43	234	211	3,88
	30/22	260	197	6,53	263	193	5,84	262	193	5,23	256	201	4,60	247	211	4,02

Ta = Indoor air temperature D.B/W.B

DB = Dry bulb

WB = Wet bulb

kWf = Cooling capacity in kW

kWs = Sensible cooling capacity (kW)

EER referred only to compressors

All cooling and thermal capacities do not take into account the heat dissipated by the fan motors

## Size 70.4 - CCK-REVO configuration

### Heating performance with 30% of outdoor and exhaust air

AIR FLOW	Ta[°C] DB/WB	Outdoor temperature [°C] DB/WB													
		-15/-16		-10/-11		-5/-6		0/1		2/1		7/6		12/11	
		kWt	COP	kWt	COP	kWt	COP	kWt	COP	kWt	COP	kWt	COP	kWt	COP
29000 m³/h	10	123	4,33	141	4,43	162	4,55	162	4,55	195	4,64	221	4,68	221	4,68
	15	123	4,06	141	4,16	162	4,25	162	4,25	195	4,35	220	4,36	220	4,36
	18	123	3,89	141	3,99	162	4,09	162	4,09	194	4,16	219	4,17	219	4,17
	20	123	3,80	141	3,90	162	3,98	162	3,98	194	4,06	219	4,07	219	4,07
	22	123	3,70	141	3,79	162	3,88	162	3,88	194	3,95	218	3,95	218	3,95
	25	123	3,55	141	3,64	162	3,74	162	3,74	162	3,74	162	3,74	162	3,74
37000 m³/h	10	123	4,59	141	4,75	162	4,91	162	4,91	196	5,12	223	5,22	223	5,22
	15	123	4,30	141	4,45	162	4,59	162	4,59	195	4,77	222	4,86	222	4,86
	18	123	4,14	141	4,27	162	4,41	162	4,41	195	4,58	221	4,66	221	4,66
	20	123	4,03	141	4,16	162	4,30	162	4,30	195	4,46	220	4,52	220	4,52
	22	123	3,93	141	4,05	162	4,19	162	4,19	195	4,35	220	4,40	220	4,40
	25	123	3,77	141	3,90	162	4,03	162	4,03	162	4,03	162	4,03	162	4,03
47000 m³/h	10	123	4,80	141	5,00	162	5,21	162	5,21	196	5,51	224	5,70	224	5,70
	15	123	4,51	141	4,68	162	4,88	162	4,88	196	5,14	223	5,30	223	5,30
	18	123	4,33	141	4,50	162	4,70	162	4,70	196	4,94	222	5,07	222	5,07
	20	123	4,23	141	4,39	162	4,56	162	4,56	195	4,79	222	4,94	222	4,94
	22	123	4,11	141	4,27	162	4,45	162	4,45	195	4,67	221	4,78	221	4,78
	25	123	3,95	141	4,11	162	4,29	162	4,29	162	4,29	162	4,29	162	4,29

Ta = Indoor ambient temperature DB/WB

DB = Dry bulb

kWt = Heating capacity supplied (kW)

COP referred to compressors only

# Performance

## Size 80.4 - CCK-REVO configuration

### Cooling performance with 30% of outdoor and exhaust air

AIR FLOW	Ta[°C] DB/ WB	Outdoor temperature [°C] DB/WB														
		20/12			25/18			30/22			35/24			40/25		
		kWf	kWs	EER	kWf	kWs	EER	kWf	kWs	EER	kWf	kWs	EER	kWf	kWs	EER
29000 m³/h	20/15	225	158	5,13	231	151	4,66	233	149	4,22	229	152	3,73	222	157	3,27
	23/17	235	164	5,28	240	158	4,77	242	156	4,32	238	159	3,83	230	164	3,34
	26/18	240	176	5,36	245	170	4,84	246	168	4,36	242	171	3,87	235	177	3,39
	27/19	245	175	5,43	250	170	4,90	251	168	4,42	247	171	3,91	239	177	3,43
	30/22	262	172	5,68	266	168	5,11	267	167	4,60	262	171	4,07	253	177	3,55
44000 m³/h	20/15	245	186	5,43	250	177	4,90	251	174	4,42	246	179	3,90	238	188	3,42
	23/17	256	193	5,59	260	186	5,03	261	184	4,54	255	189	3,99	247	198	3,50
	26/18	261	210	5,66	265	203	5,10	266	201	4,59	260	207	4,04	251	216	3,54
	27/19	267	209	5,75	271	203	5,17	271	201	4,65	265	207	4,10	256	216	3,58
	30/22	284	205	5,98	287	200	5,35	286	200	4,80	280	207	4,23	270	216	3,70
47000 m³/h	20/15	248	191	5,47	253	182	4,94	254	179	4,46	249	184	3,94	240	194	3,44
	23/17	259	198	5,64	263	191	5,07	263	189	4,56	258	195	4,02	249	205	3,52
	26/18	264	216	5,70	268	209	5,13	268	208	4,61	263	214	4,08	254	223	3,57
	27/19	270	215	5,79	273	208	5,19	273	207	4,66	267	214	4,11	258	224	3,60
	30/22	287	211	6,03	290	206	5,40	289	206	4,82	282	213	4,25	272	224	3,71

Ta = Indoor air temperature D.B/W.B

DB = Dry bulb

WB = Wet bulb

kWf = Cooling capacity in kW

kWs = Sensible cooling capacity (kW)

EER referred only to compressors

All cooling and thermal capacities do not take into account the heat dissipated by the fan motors

## Size 80.4 - CCK-REVO configuration

### Heating performance with 30% of outdoor and exhaust air

AIR FLOW	Ta[°C] DB/WB	Outdoor temperature [°C] DB/WB													
		-15/-16		-10/-11		-5/-6		0/1		2/1		7/6		12/11	
		kWt	COP	kWt	COP	kWt	COP	kWt	COP	kWt	COP	kWt	COP	kWt	COP
29000 m³/h	10	139	4,16	159	4,23	182	4,29	182	4,29	219	4,35	248	4,34	248	4,34
	15	139	3,89	159	3,97	182	4,02	182	4,02	219	4,07	247	4,04	247	4,04
	18	139	3,75	159	3,81	182	3,86	182	3,86	218	3,89	246	3,87	246	3,87
	20	139	3,65	159	3,71	182	3,76	182	3,76	218	3,80	246	3,78	246	3,78
	22	139	3,55	159	3,61	182	3,67	182	3,67	218	3,69	245	3,66	245	3,66
	25	139	3,41	160	3,49	182	3,53	182	3,53	182	3,53	182	3,53	182	3,53
44000 m³/h	10	138	4,58	159	4,75	183	4,93	183	4,93	221	5,14	251	5,24	251	5,24
	15	138	4,29	159	4,45	182	4,60	182	4,60	220	4,79	250	4,88	250	4,88
	18	138	4,12	159	4,29	182	4,42	182	4,42	220	4,60	249	4,69	249	4,69
	20	139	4,05	159	4,17	182	4,30	182	4,30	219	4,47	248	4,55	248	4,55
	22	139	3,95	159	4,07	182	4,19	182	4,19	219	4,35	248	4,43	248	4,43
	25	139	3,80	159	3,92	182	4,04	182	4,04	182	4,04	182	4,04	182	4,04
47000 m³/h	10	138	4,65	159	4,82	183	5,01	183	5,01	221	5,25	251	5,36	251	5,36
	15	138	4,34	159	4,52	182	4,67	182	4,67	220	4,89	250	5,00	250	5,00
	18	138	4,18	159	4,34	182	4,49	182	4,49	220	4,70	249	4,80	249	4,80
	20	139	4,10	159	4,24	182	4,38	182	4,38	220	4,58	249	4,67	249	4,67
	22	139	4,01	159	4,13	182	4,26	182	4,26	219	4,44	248	4,53	248	4,53
	25	139	3,84	159	3,98	182	4,11	182	4,11	182	4,11	182	4,11	182	4,11

Ta = Indoor ambient temperature DB/WB

DB = Dry bulb

kWt = Heating capacity supplied (kW)

COP referred to compressors only

## Size 90.4 - CCK-REVO configuration

### Cooling performance with 30% of outdoor and exhaust air

AIR FLOW	Ta[°C] DB/ WB	Outdoor temperature [°C] DB/WB														
		20/12			25/18			30/22			35/24			40/25		
		kWf	kWs	EER	kWf	kWs	EER	kWf	kWs	EER	kWf	kWs	EER	kWf	kWs	EER
38000 m³/h	20/15	257	183	5,66	265	175	5,18	267	173	4,68	263	177	4,15	256	184	3,65
	23/17	269	190	5,86	275	183	5,31	278	181	4,82	273	185	4,25	265	193	3,73
	26/18	275	205	5,95	281	198	5,38	283	197	4,88	279	201	4,33	270	208	3,78
	27/19	281	204	6,04	287	198	5,47	289	196	4,95	284	201	4,38	276	209	3,84
	30/22	300	201	6,32	306	196	5,72	307	195	5,16	301	200	4,55	292	209	3,99
49000 m³/h	20/15	271	202	5,89	278	193	5,35	280	190	4,84	275	196	4,28	266	206	3,74
	23/17	283	210	6,07	289	202	5,49	290	200	4,96	285	207	4,38	276	217	3,84
	26/18	288	228	6,14	294	221	5,56	296	220	5,03	291	226	4,45	281	236	3,88
	27/19	295	227	6,25	300	221	5,64	302	220	5,10	296	226	4,50	287	237	3,94
	30/22	315	223	6,54	320	218	5,89	320	219	5,30	313	226	4,67	303	237	4,09
60000 m³/h	20/15	280	219	6,02	287	209	5,47	288	206	4,93	283	214	4,37	274	227	3,82
	23/17	292	229	6,20	298	220	5,61	299	218	5,06	293	227	4,47	284	240	3,91
	26/18	298	250	6,29	304	243	5,69	304	242	5,12	299	250	4,53	289	263	3,96
	27/19	305	249	6,39	310	242	5,76	310	242	5,18	304	250	4,58	294	263	4,01
	30/22	325	245	6,67	329	239	6,00	329	240	5,40	322	250	4,76	311	264	4,16

Ta = Indoor air temperature D.B/W.B

DB = Dry bulb

WB = Wet bulb

kWf = Cooling capacity in kW

kWs = Sensible cooling capacity (kW)

EER referred only to compressors

All cooling and thermal capacities do not take into account the heat dissipated by the fan motors

## Size 90.4 - CCK-REVO configuration

### Heating performance with 30% of outdoor and exhaust air

AIR FLOW	Ta[°C] DB/WB	Outdoor temperature [°C] DB/WB													
		-15/-16		-10/-11		-5/-6		0/1		2/1		7/6		12/11	
		kWt	COP	kWt	COP	kWt	COP	kWt	COP	kWt	COP	kWt	COP	kWt	COP
38000 m³/h	10	157	4,46	181	4,63	208	4,75	208	4,75	251	4,85	284	4,86	284	4,86
	15	157	4,19	181	4,35	208	4,45	208	4,45	250	4,54	283	4,54	283	4,54
	18	158	4,06	181	4,18	208	4,29	208	4,29	249	4,35	282	4,36	282	4,36
	20	158	3,96	181	4,09	208	4,19	208	4,19	249	4,23	281	4,23	281	4,23
	22	158	3,87	181	3,98	207	4,06	207	4,06	249	4,13	280	4,11	280	4,11
	25	158	3,73	181	3,83	207	3,91	207	3,91	207	3,91	207	3,91	207	3,91
49000 m³/h	10	157	4,71	180	4,92	209	5,15	209	5,15	252	5,35	287	5,45	287	5,45
	15	157	4,42	181	4,64	208	4,80	208	4,80	251	4,99	285	5,06	285	5,06
	18	157	4,27	181	4,47	208	4,62	208	4,62	251	4,80	284	4,86	284	4,86
	20	157	4,16	181	4,36	208	4,50	208	4,50	250	4,66	284	4,73	284	4,73
	22	158	4,09	181	4,25	208	4,40	208	4,40	250	4,55	283	4,59	283	4,59
	25	158	3,94	181	4,10	208	4,24	208	4,24	208	4,24	208	4,24	208	4,24
60000 m³/h	10	157	4,89	180	5,13	209	5,41	209	5,41	253	5,70	289	5,87	289	5,87
	15	157	4,59	180	4,81	208	5,05	208	5,05	252	5,32	287	5,46	287	5,46
	18	157	4,42	181	4,66	208	4,86	208	4,86	252	5,11	286	5,23	286	5,23
	20	157	4,31	181	4,55	208	4,74	208	4,74	251	4,96	285	5,08	285	5,08
	22	157	4,22	181	4,44	208	4,61	208	4,61	251	4,84	285	4,95	285	4,95
	25	158	4,09	181	4,27	208	4,44	208	4,44	208	4,44	208	4,44	208	4,44

Ta = Indoor ambient temperature DB/WB

DB = Dry bulb

kWt = Heating capacity supplied (kW)

COP referred to compressors only



# Performance

## Size 100.4 - CCK-REVO configuration

### Cooling performance with 30% of outdoor and exhaust air

AIR FLOW	Ta[°C] DB/ WB	Outdoor temperature [°C] DB/WB														
		20/12			25/18			30/22			35/24			40/25		
		kWf	kWs	EER	kWf	kWs	EER	kWf	kWs	EER	kWf	kWs	EER	kWf	kWs	EER
38000 m <sup>3</sup> /h	20/15	278	196	5,52	286	187	5,04	289	184	4,57	284	188	4,04	276	195	3,54
	23/17	291	202	5,69	298	195	5,17	300	193	4,68	295	197	4,14	287	204	3,64
	26/18	297	217	5,78	304	211	5,24	306	209	4,74	301	213	4,20	292	220	3,68
	27/19	303	216	5,85	310	210	5,31	312	208	4,81	307	213	4,25	298	220	3,73
	30/22	324	213	6,12	330	208	5,54	331	207	4,99	325	212	4,41	315	220	3,87
53000 m <sup>3</sup> /h	20/15	298	222	5,80	305	212	5,25	307	208	4,75	301	215	4,20	292	225	3,68
	23/17	311	230	5,96	317	222	5,39	319	220	4,88	313	226	4,31	303	237	3,77
	26/18	317	250	6,04	323	242	5,46	325	241	4,94	319	247	4,36	308	258	3,81
	27/19	324	249	6,12	330	242	5,54	331	240	4,99	324	247	4,40	314	259	3,86
	30/22	346	245	6,40	351	239	5,76	350	239	5,17	343	247	4,57	332	259	4,00
60000 m <sup>3</sup> /h	20/15	304	233	5,87	311	222	5,33	313	219	4,82	307	226	4,25	297	239	3,72
	23/17	318	243	6,06	323	233	5,46	325	231	4,93	318	239	4,35	308	252	3,81
	26/18	324	264	6,12	330	256	5,54	331	255	4,99	324	263	4,40	313	275	3,85
	27/19	331	263	6,22	336	255	5,60	337	255	5,05	330	263	4,45	319	276	3,89
	30/22	353	258	6,49	357	252	5,82	357	253	5,24	349	262	4,62	337	276	4,04

Ta = Indoor air temperature D.B/W.B

DB = Dry bulb

WB = Wet bulb

kWf = Cooling capacity in kW

kWs = Sensible cooling capacity (kW)

EER referred only to compressors

All cooling and thermal capacities do not take into account the heat dissipated by the fan motors

## Size 100.4 - CCK-REVO configuration

### Heating performance with 30% of outdoor and exhaust air

AIR FLOW	Ta[°C] DB/WB	Outdoor temperature [°C] DB/WB													
		-15/-16		-10/-11		-5/-6		0/1		2/1		7/6		12/11	
		kWt	COP	kWt	COP	kWt	COP	kWt	COP	kWt	COP	kWt	COP	kWt	COP
38000 m <sup>3</sup> /h	10	172	4,26	197	4,37	227	4,48	227	4,48	273	4,53	308	4,50	308	4,50
	15	172	4,00	197	4,10	227	4,20	227	4,20	272	4,24	307	4,20	307	4,20
	18	172	3,86	197	3,96	226	4,03	226	4,03	271	4,06	306	4,03	306	4,03
	20	172	3,76	197	3,86	226	3,92	226	3,92	271	3,96	305	3,92	305	3,92
	22	172	3,68	197	3,77	226	3,83	226	3,83	271	3,86	304	3,80	304	3,80
	25	173	3,57	197	3,63	226	3,69	226	3,69	226	3,69	226	3,69	226	3,69
53000 m <sup>3</sup> /h	10	171	4,57	197	4,78	227	4,97	227	4,97	275	5,17	312	5,24	312	5,24
	15	171	4,30	197	4,49	227	4,66	227	4,66	274	4,83	310	4,88	310	4,88
	18	172	4,16	197	4,33	227	4,49	227	4,49	273	4,63	309	4,68	309	4,68
	20	172	4,07	197	4,22	227	4,37	227	4,37	273	4,51	309	4,56	309	4,56
	22	172	3,97	197	4,11	227	4,27	227	4,27	272	4,39	308	4,43	308	4,43
	25	172	3,83	197	3,97	226	4,09	226	4,09	226	4,09	226	4,09	226	4,09
60000 m <sup>3</sup> /h	10	171	4,68	197	4,91	227	5,12	227	5,12	275	5,37	313	5,49	313	5,49
	15	171	4,40	197	4,61	227	4,81	227	4,81	274	5,02	311	5,12	311	5,12
	18	172	4,27	197	4,45	227	4,63	227	4,63	274	4,82	310	4,91	310	4,91
	20	172	4,16	197	4,34	227	4,51	227	4,51	273	4,68	310	4,78	310	4,78
	22	172	4,07	197	4,23	227	4,40	227	4,40	273	4,57	309	4,64	309	4,64
	25	172	3,92	197	4,08	227	4,24	227	4,24	227	4,24	227	4,24	227	4,24

Ta = Indoor ambient temperature DB/WB

DB = Dry bulb

kWt = Heating capacity supplied (kW)

COP referred to compressors only

## Size 120.4 - CCK-REVO configuration

### Cooling performance with 30% of outdoor and exhaust air

AIR FLOW	Ta[°C] DB/ WB	Outdoor temperature [°C] DB/WB														
		20/12			25/18			30/22			35/24			40/25		
		kWf	kWs	EER	kWf	kWs	EER	kWf	kWs	EER	kWf	kWs	EER	kWf	kWs	EER
38000 m³/h	20/15	317	218	4,99	325	209	4,51	329	206	4,09	324	209	3,61	314	216	3,15
	23/17	331	225	5,13	339	218	4,64	342	215	4,20	336	218	3,70	326	225	3,23
	26/18	338	241	5,21	346	234	4,70	348	231	4,24	343	234	3,74	332	241	3,25
	27/19	346	240	5,28	353	233	4,76	355	231	4,29	349	234	3,78	338	241	3,28
	30/22	369	237	5,50	376	231	4,95	377	229	4,45	370	233	3,92	358	240	3,41
58000 m³/h	20/15	348	256	5,30	356	244	4,78	358	240	4,31	351	246	3,80	339	257	3,29
	23/17	363	265	5,44	370	255	4,90	372	252	4,42	364	259	3,88	352	270	3,38
	26/18	371	287	5,52	377	278	4,95	378	275	4,46	371	282	3,93	358	293	3,41
	27/19	379	286	5,59	385	277	5,02	386	275	4,51	378	282	3,97	365	293	3,44
	30/22	404	280	5,80	409	273	5,20	408	273	4,66	399	281	4,10	385	293	3,56
60000 m³/h	20/15	351	259	5,33	358	247	4,80	360	243	4,33	353	249	3,81	341	261	3,31
	23/17	366	269	5,47	372	258	4,91	374	255	4,43	366	262	3,89	354	274	3,40
	26/18	373	291	5,53	380	282	4,98	380	279	4,47	373	286	3,94	360	298	3,43
	27/19	381	290	5,60	387	281	5,03	388	279	4,53	380	286	3,99	367	298	3,46
	30/22	406	284	5,82	411	277	5,22	410	277	4,68	401	285	4,11	387	298	3,58

Ta = Indoor air temperature D.B/WB

DB = Dry bulb

WB = Wet bulb

kWf = Cooling capacity in kW

kWs = Sensible cooling capacity (kW)

EER referred only to compressors

All cooling and thermal capacities do not take into account the heat dissipated by the fan motors

## Size 120.4 - CCK-REVO configuration

### Heating performance with 30% of outdoor and exhaust air

AIR FLOW	Ta[°C] DB/WB	Outdoor temperature [°C] DB/WB													
		-15/-16		-10/-11		-5/-6		0/1		2/1		7/6		12/11	
		kWt	COP	kWt	COP	kWt	COP	kWt	COP	kWt	COP	kWt	COP	kWt	COP
38000 m³/h	10	206	3,89	235	3,93	269	3,96	269	3,96	321	3,91	361	3,82	361	3,82
	15	206	3,63	236	3,69	269	3,70	269	3,70	320	3,63	360	3,56	360	3,56
	18	207	3,50	236	3,54	269	3,55	269	3,55	320	3,48	359	3,39	359	3,39
	20	207	3,41	236	3,45	269	3,44	269	3,44	320	3,39	358	3,28	358	3,28
	22	207	3,32	237	3,36	270	3,36	270	3,36	320	3,30	358	3,20	358	3,20
	25	208	3,20	237	3,22	270	3,23	270	3,23	270	3,23	270	3,23	270	3,23
58000 m³/h	10	205	4,38	235	4,52	269	4,65	269	4,65	323	4,75	366	4,78	366	4,78
	15	205	4,09	235	4,23	269	4,34	269	4,34	322	4,43	364	4,44	364	4,44
	18	206	3,95	235	4,07	269	4,17	269	4,17	322	4,25	363	4,26	363	4,26
	20	206	3,85	235	3,96	269	4,06	269	4,06	322	4,14	363	4,14	363	4,14
	22	206	3,75	235	3,85	269	3,95	269	3,95	321	4,02	362	4,02	362	4,02
	25	206	3,60	236	3,72	269	3,80	269	3,80	269	3,80	269	3,80	269	3,80
60000 m³/h	10	205	4,41	235	4,56	269	4,69	269	4,69	323	4,81	366	4,85	366	4,85
	15	205	4,12	235	4,26	269	4,39	269	4,39	323	4,50	365	4,52	365	4,52
	18	205	3,97	235	4,10	269	4,22	269	4,22	322	4,30	364	4,33	364	4,33
	20	206	3,88	235	4,00	269	4,10	269	4,10	322	4,20	363	4,21	363	4,21
	22	206	3,78	235	3,88	269	3,99	269	3,99	322	4,09	363	4,09	363	4,09
	25	206	3,63	236	3,75	269	3,84	269	3,84	269	3,84	269	3,84	269	3,84

Ta = Indoor ambient temperature DB/WB

DB = Dry bulb

kWt = Heating capacity supplied (kW)

COP referred to compressors only

# Dimensional drawings

Size 60.4 - 70.4 - 80.4 CAK/CBK/CBK-G/CCK-REVO

DAA9V0002\_00 REV00  
DATA/DATE 13/04/2022

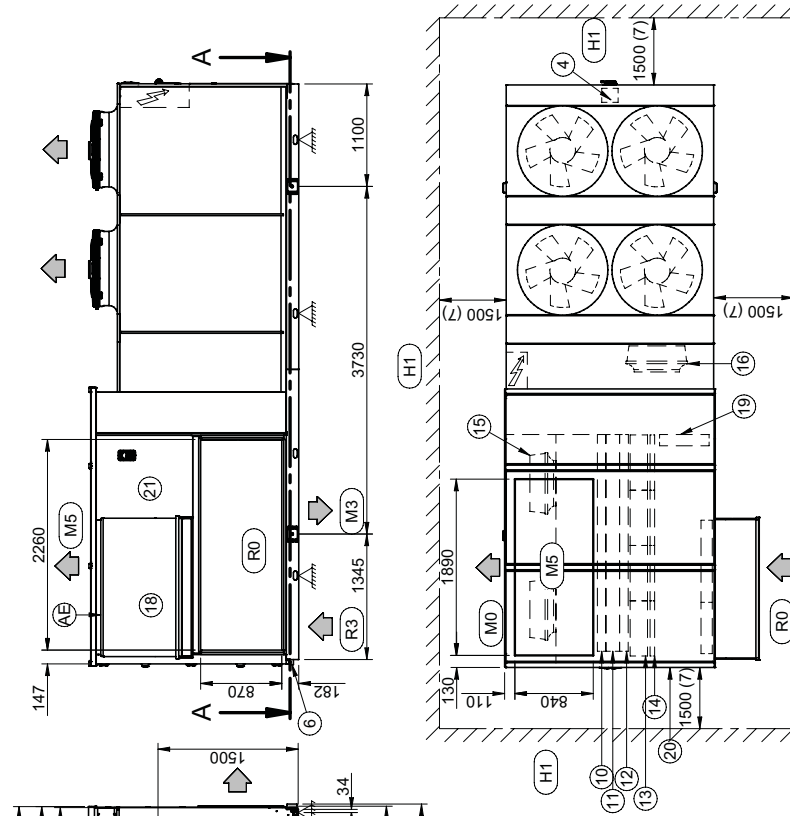

- 17. Liftin bracket (Removable)
  - 18. Fresh air damper
  - 19. Over pressure damper discharge (CCK REVO Version)
  - 20. Coil-filters-heaters inspection
  - 21. Outdoor air return cap, accessory disassembled supplied
- (RO) Horizontal air return  
(R3) Downward air return  
(MO) Horizontal air supply  
(M3) Downward air supply  
(M5) Vertical air supply  
(AE) Outdoor air return (CBK / CBK-G / CCK-REVO version)  
(HI) Wall with same height as unit on a maximum of three sides  
(\*) Vibration mounts position

- 1. Compressor compartment
- 2. Electrical panel
- 3. Connector for keyboard or PC connection
- 4. Power input
- 5. Humidifier connections 1/2" M
- 6. Condensate drain with siphon
- 7. Functional clearances
- 8. Heating coil inlet H<sub>2</sub>O Ø 2"
- 9. Heating coil outlet H<sub>2</sub>O Ø 2"
- 10. Post-heating coil
- 11. Treatment coil
- 12. Heating coil H<sub>2</sub>O
- 13. Filters F7 - Filters F9 - Electrostatic filters
- 14. Filters G4
- 15. Electric fan (supply-return)
- 16. Discharge fun (CCK REVO version)

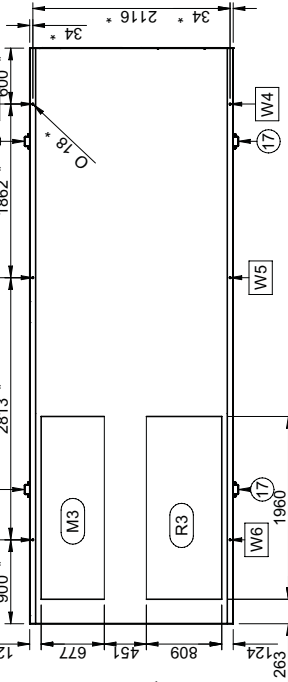

Configuration	60.4		70.4		80.4		80.4	
	CAK/CBK/ CBKG	CCK-REVO	CAK/CBK/ CBKG	CCK-REVO	CAK/CBK/ CBKG	CCK-REVO	CCK-REVO	CCK-REVO
W1 Support point	kg 413	407	kg 423	417	kg 423	417	417	417
W2 Support point	kg 495	530	kg 506	541	kg 506	541	541	541
W3 Support point	kg 451	458	kg 450	457	kg 450	450	457	457
W4 Support point	kg 409	392	kg 419	402	kg 419	419	402	402
W5 Support point	kg 474	575	kg 483	584	kg 483	584	584	584
W6 Support point	kg 363	383	kg 362	383	kg 362	383	383	383
Operation weight	kg 2605	2745	kg 2643	2783	kg 2643	2783	2783	2783
Shipping weight	kg 2605	2745	kg 2643	2783	kg 2643	2783	2783	2783

Optional accessories may result in a substantial variation of the weight show in table

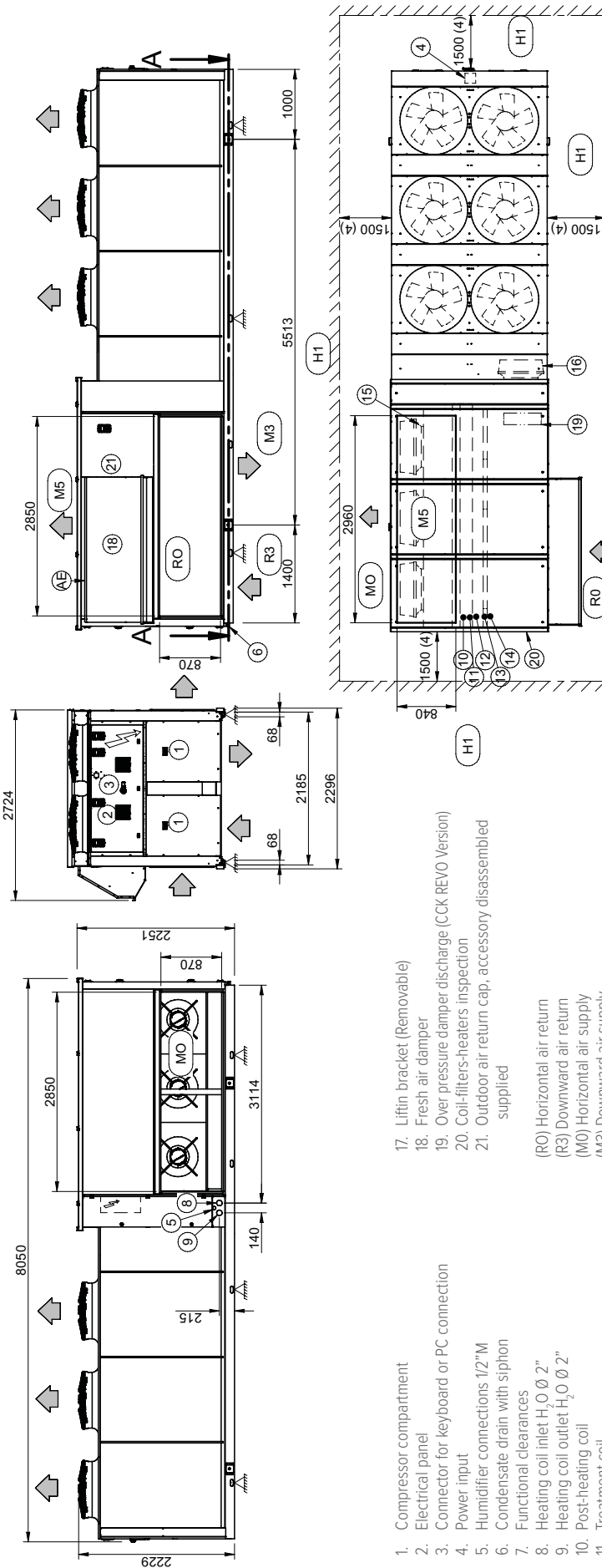

1. Compressor compartment
  2. Electrical panel
  3. Connector for keyboard or PC connection
  4. Power input
  5. Humidifier connections 1/2" M
  6. Condensate drain with siphon
  7. Functional clearances
  8. Heating coil inlet H<sub>2</sub>O Ø 2"
  9. Heating coil outlet H<sub>2</sub>O Ø 2"
  10. Post-heating coil
  11. Treatment coil
  12. Heating coil H<sub>2</sub>O
  13. Filters F7 - Filters F9 - Electrostatic filters
  14. Filters G4
  15. Electric fan (supply-return)
  16. Discharge fan (CCK REVO version)
  17. Liftin bracket (Removable)
  18. Fresh air damper
  19. Over pressure damper discharge (CCK REVO Version)
  20. Coil-filters-heaters inspection
  21. Outdoor air return cap, accessory disassembled supplied
- (RO) Horizontal air return  
(R3) Downward air return  
(MO) Horizontal air supply  
(M3) Downward air supply  
(M5) Vertical air supply  
(AE) Outdoor air return (CBK / CBK-G / CCK-REVO version)  
(H1) Wall with same height as unit on a maximum of three sides  
(\*) Vibration mounts position

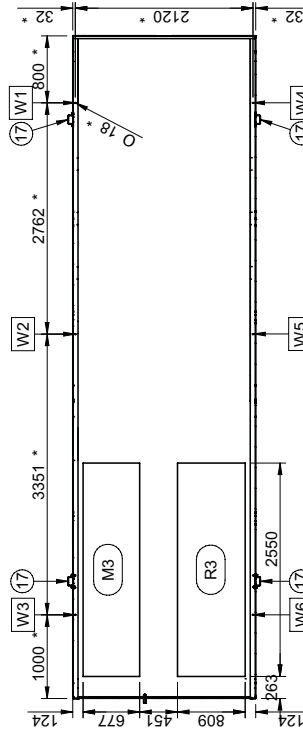

## WEIGHT DISTRIBUTION

SIZE	90.4	90.4	100.4	100.4	120.4	120.4
Configuration	CAK/CBK/ CBKG	CCK-REVO	CAK/CBK/ CBKG	CCK-REVO	CAK/CBK/ CBKG	CCK-REVO
W1 Support point	kg 569	558	569	558	640	628
W2 Support point	kg 686	767	686	767	734	815
W3 Support point	kg 582	603	582	603	576	597
W4 Support point	kg 541	529	541	529	598	586
W5 Support point	kg 691	782	691	782	740	831
W6 Support point	kg 467	490	467	490	461	484
Operation weight	kg 3536	3728	3536	3728	3750	3942
Shipping weight	kg 3536	3728	3536	3728	3750	3942

Optional accessories may result in a substantial variation of the weight show in table

# Dimensional drawings

Size 60.4 - 70.4 - 80.4 CAK / CBK / CBK-G / CCK-REVO  
with gas module GC10X - GC11X

DAA9V0005\_00 REV00  
DATA/DATE 01/07/2022

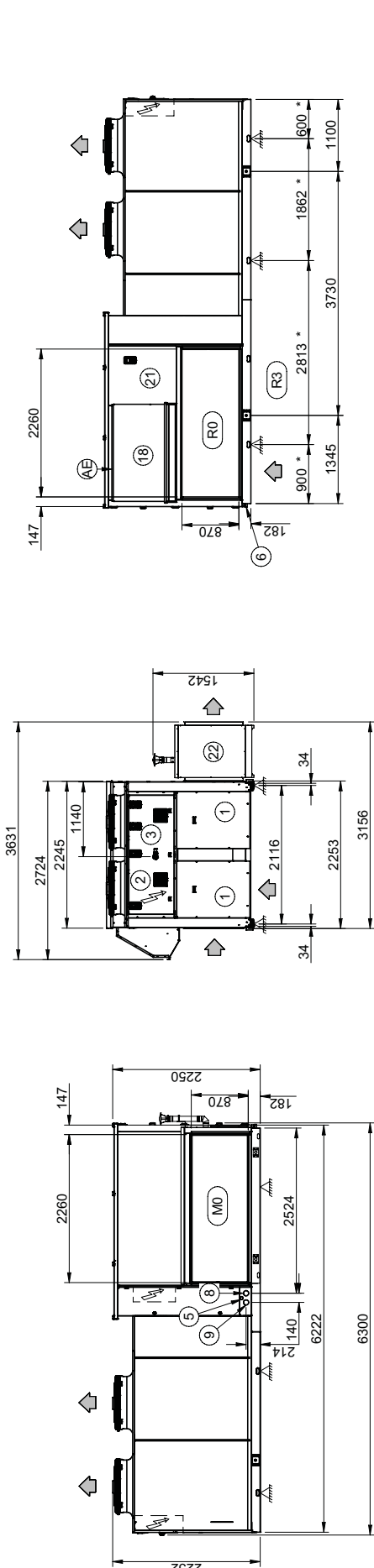

1. Compressor compartment
  2. Electrical panel
  3. Connector for keyboard or PC connection
  4. Power input
  5. Humidifier connections 1/2" M
  6. Condensate drain with siphon
  7. Functional clearances
  8. Heating coil inlet H<sub>2</sub>O Ø 2"
  9. Heating coil outlet H<sub>2</sub>O Ø 2"
  10. Post-heating coil
  11. Treatment coil
  12. Heating coil H<sub>2</sub>O
  13. Filters F7 - Filters F9 - Electrostatic filters
  14. Filters G4
  15. Electric fan (supply-return)
  16. Discharge fan (CCK REVO version)
  17. Lifin bracket (Removable)
  18. Fresh air damper
  19. Over pressure damper discharge (CCK REVO Version)
  20. Coil-filters-heaters inspection
  21. Outdoor air return cap, accessory disassembled supplied
  22. Gas module (be connected to the unit a pose in operations)
- (RO) Horizontal air return  
(R3) Downward air return  
(M0) Horizontal air supply  
(AE) Outdoor air return (CBK / CBK-G / CCK-REVO version)  
(H1) Wall with same height as unit on a maximum of three sides  
(\*) Vibration mounts position

## WEIGHT DISTRIBUTION

SIZE	60.4	70.4	80.4	80.4
Configuration	CAK/CBK/ CBKG	CAK/CBK/ CBKG	CCK-REVO	CCK-REVO
W1 Support point	kg 413	423	417	417
W2 Support point	kg 495	506	541	541
W3 Support point	kg 451	450	457	457
W4 Support point	kg 409	419	402	402
W5 Support point	kg 474	483	584	584
W6 Support point	kg 363	362	383	383
Operation weight	kg 2605	2643	2783	2783
Shipping weight	kg 2605	2643	2783	2783

## GAS MODULE WEIGHT DISTRIBUTION

SIZE	60.4 - 70.4 - 80.4
W7 Support point	kg 85
W8 Support point	kg 75
W9 Support point	kg 75
W10 Support point	kg 85
Operation weight	kg 320
Shipping weight	kg 320

Optional accessories may result in a substantial variation of the weight show in table

Size 60.4 - 70.4 - 80.4 CAK / CBK / CBK-G / CCK-REVO  
with gas module GC13X - GC06X

DAA9V0006\_00 REV00  
DATA/DATE 01/07/2022

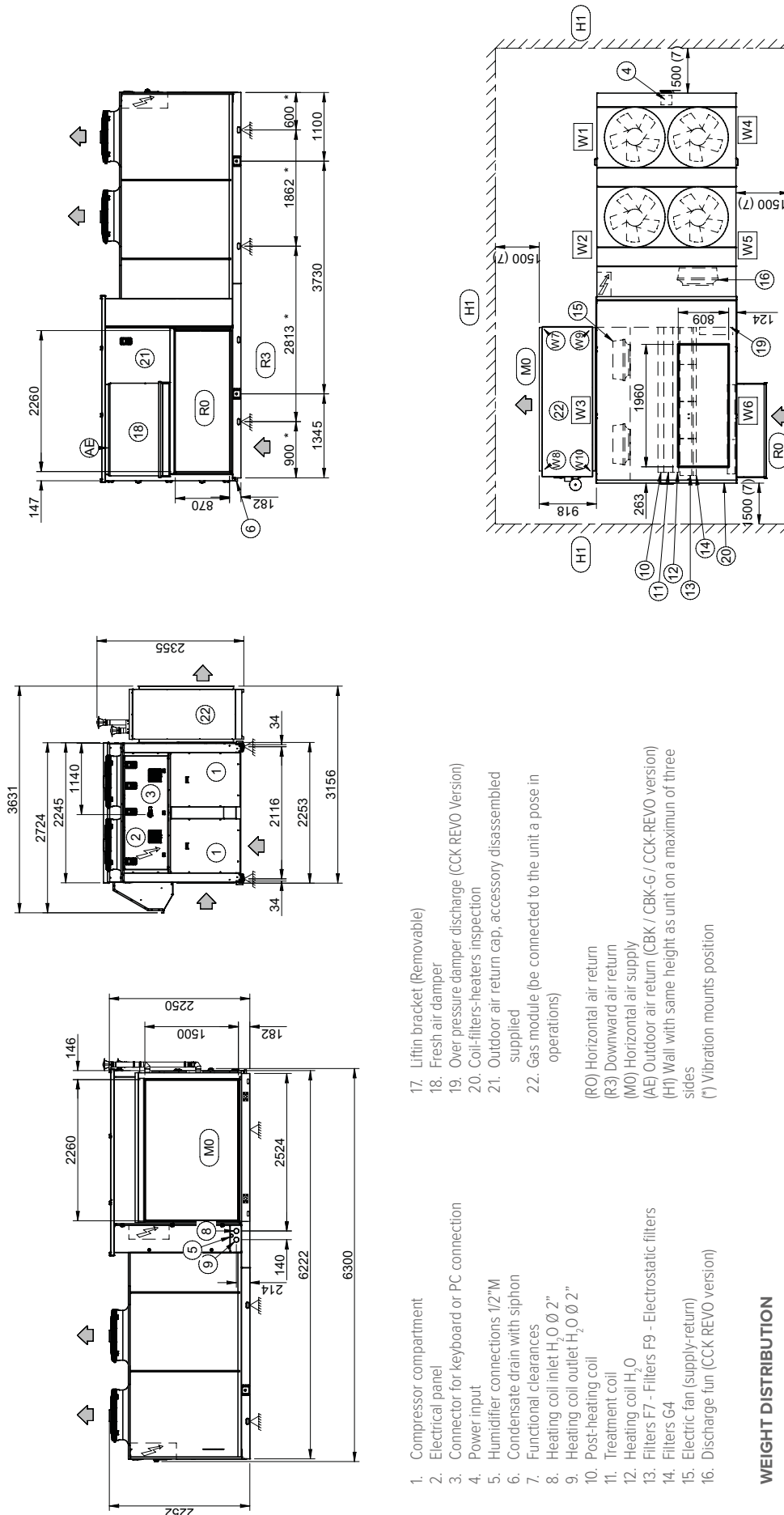

## WEIGHT DISTRIBUTION

SIZE	60.4	70.4	70.4	80.4	80.4
Configuration	CAK/CBK/ CBKG	CCK-REVO	CAK/CBK/ CBKG	CCK-REVO	CAK/CBK/ CBKG
W1 Support point	kg 413	407	423	417	417
W2 Support point	kg 495	530	506	541	541
W3 Support point	kg 451	458	450	457	457
W4 Support point	kg 409	392	419	402	402
W5 Support point	kg 474	575	483	584	584
W6 Support point	kg 363	383	362	383	383
Operation weight	kg 2605	2745	2643	2783	2643
Shipping weight	kg 2605	2745	2643	2783	2643

## GAS MODULE WEIGHT DISTRIBUTION

SIZE	60.4 - 70.4 - 80.4
W7 Support point	kg 145
W8 Support point	kg 100
W9 Support point	kg 145
W10 Support point	kg 400
Operation weight	kg 490
Shipping weight	kg 490

Optional accessories may result in a substantial variation of the weight show in table

# Dimensional drawings

Size 90.4 - 100.4 - 120.4 CAK / CBK / CBK-G / CCK-REVO  
with gas module GC12X - GC13X - GC06X

DAA9V0007\_00 REV00  
DATA/DATE 04/07/2022

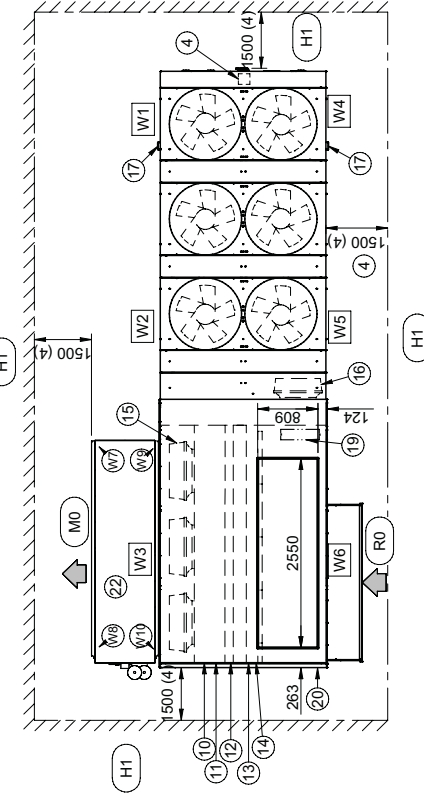
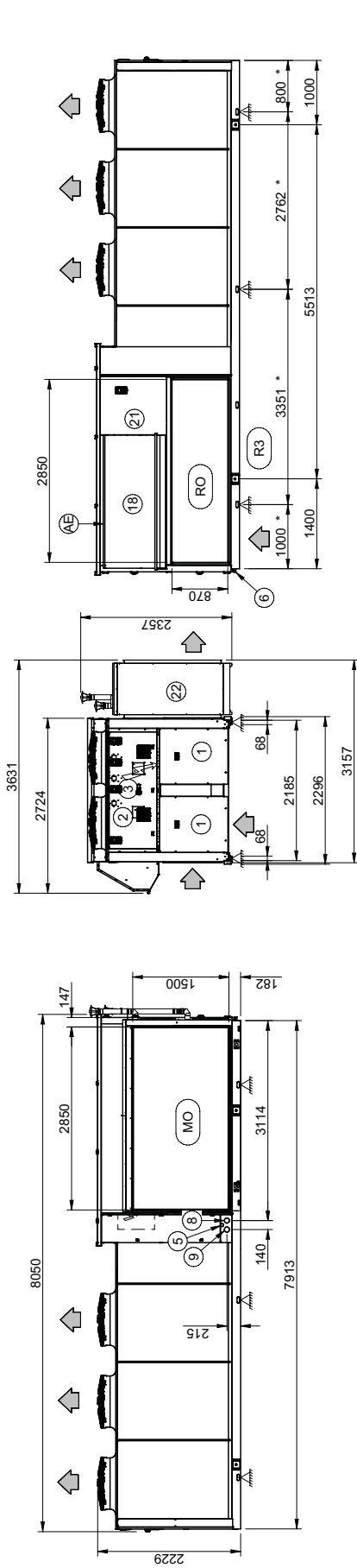

1. Compressor compartment
  2. Electrical panel
  3. Connector for keyboard or PC connection
  4. Power input
  5. Humidifier connections 1/2" M
  6. Condensate drain with siphon
  7. Functional clearances
  8. Heating coil inlet H<sub>2</sub>O Ø 2"
  9. Heating coil outlet H<sub>2</sub>O Ø 2"
  10. Post-heating coil
  11. Treatment coil
  12. Heating coil H<sub>2</sub>O
  13. Filters F7 - Filters F9 - Electrostatic filters
  14. Filters G4
  15. Electric fan (supply-return)
  16. Discharge fan (CCK REVO version)
  17. Lift-in bracket (Removable)
  18. Fresh air damper
  19. Over pressure damper discharge (CCK REVO Version)
  20. Coil-filters-heaters inspection
  21. Outdoor air return cap, accessory disassembled supplied
  22. Gas module (be connected to the unit a pose in operations)
- (RO) Horizontal air return  
(R3) Downward air return  
(M0) Horizontal air supply  
(AE) Outdoor air return (CBK / CBK-G / CCK-REVO version)  
(H1) Wall with same height as unit on a maximum of three sides  
(\*) Vibration mounts position

## WEIGHT DISTRIBUTION

SIZE	90.4	100.4	100.4	120.4	120.4
Configuration	CAK/CBK/ CBKG	CCK-REVO	CAK/CBK/ CBKG	CCK-REVO	CAK/CBK/ CBKG
W1 Support point	569	558	569	558	628
W2 Support point	686	767	686	767	815
W3 Support point	582	603	582	603	597
W4 Support point	541	529	541	529	586
W5 Support point	691	782	691	782	831
W6 Support point	467	490	467	490	484
Operation weight	3536	3728	3536	3728	3942
Shipping weight	3536	3728	3536	3728	3942

## GAS MODULE WEIGHT DISTRIBUTION

SIZE	90.4 - 100.4 - 120.4
W7 Support point	110
W8 Support point	155
W9 Support point	110
W10 Support point	155
Operation weight	530
Shipping weight	530

Optional accessories may result in a substantial variation of the weight show in table

Size 90.4 - 100.4 - 120.4 CAK / CBK / CBK-G / CCK-REVO  
with gas module GC07X

DAA9V0008\_00 REV00  
DATA/DATE 04/07/2022

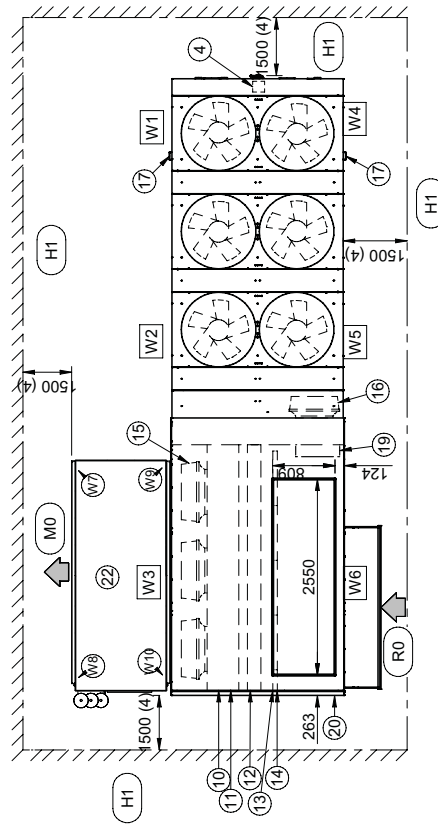
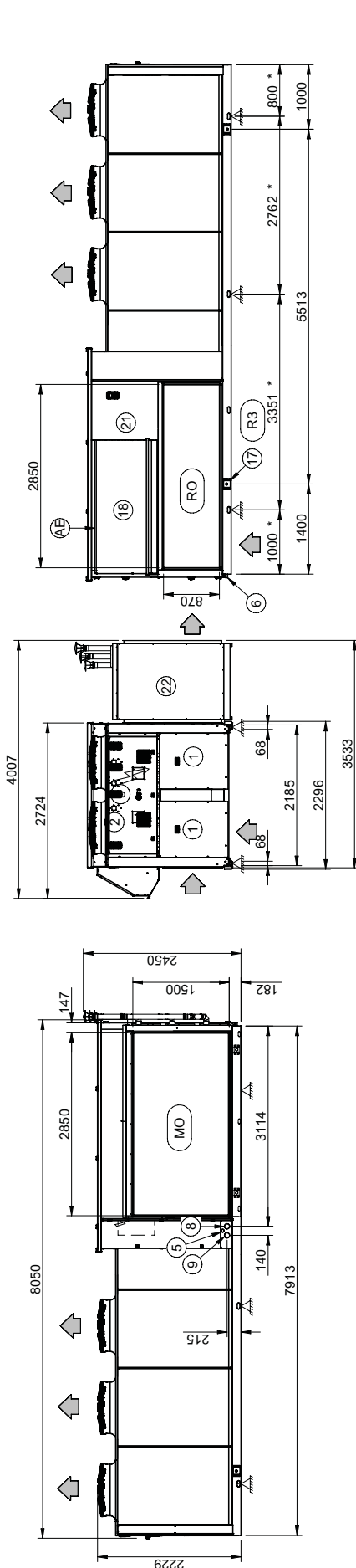

1. Compressor compartment
  2. Electrical panel
  3. Connector for keyboard or PC connection
  4. Power input
  5. Humidifier connections 1/2" M
  6. Condensate drain with siphon
  7. Functional clearances
  8. Heating coil inlet H<sub>2</sub>O Ø 2"
  9. Heating coil outlet H<sub>2</sub>O Ø 2"
  10. Post-heating coil
  11. Treatment coil
  12. Heating coil H<sub>2</sub>O
  13. Filters F7 - Filters F9 - Electrostatic filters
  14. Filters G4
  15. Electric fan (supply-return)
  16. Discharge fan (CCK REVO version)
  17. Liften bracket (Removable)
  18. Fresh air damper
  19. Over pressure damper discharge (CCK REVO Version)
  20. Coil-filters-heater's inspection
  21. Outdoor air return cap, accessory disassembled supplied
  22. Gas module (be connected to the unit a pose in operations)
- (RO) Horizontal air return  
(R3) Downward air return  
(M0) Horizontal air supply  
(AE) Outdoor air return (CBK / CBK-G / CCK-REVO version)  
(HI) Wall with same height as unit on a maximum of three sides  
(\*) Vibration mounts position

## WEIGHT DISTRIBUTION

SIZE	90.4	90.4	100.4	100.4	120.4	120.4
Configuration	CAK/CBK/ CBKG	CCK-REVO	CAK/CBK/ CBKG	CCK-REVO	CAK/CBK/ CBKG	CCK-REVO
W1 Support point	kg 569	558	569	558	640	628
W2 Support point	kg 686	767	686	767	734	815
W3 Support point	kg 582	603	582	603	576	597
W4 Support point	kg 541	529	541	529	598	586
W5 Support point	kg 691	782	691	782	740	831
W6 Support point	kg 467	490	467	490	461	484
Operation weight	kg 3536	3728	3536	3728	3750	3942
Shipping weight	kg 3536	3728	3536	3728	3750	3942

## GAS MODULE WEIGHT DISTRIBUTION

SIZE	90.4 - 100.4 - 120.4	
W7 Support point	kg	165
W8 Support point	kg	190
W9 Support point	kg	165
W10 Support point	kg	190
Operation weight	kg	710
Shipping weight	kg	710

Optional accessories may result in a substantial variation of the weight show in table



# Dimensional drawings

Size 60.4 - 70.4 - 80.4 CBK-G Version with rotary recovery module

DAA9V0009\_00 REV00  
DATA/DATE 07/09/2022

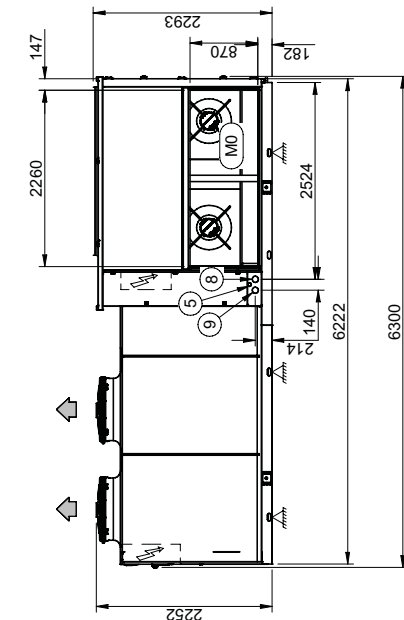
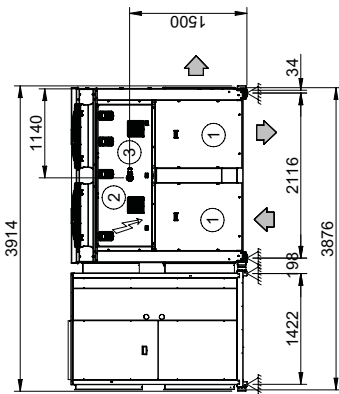
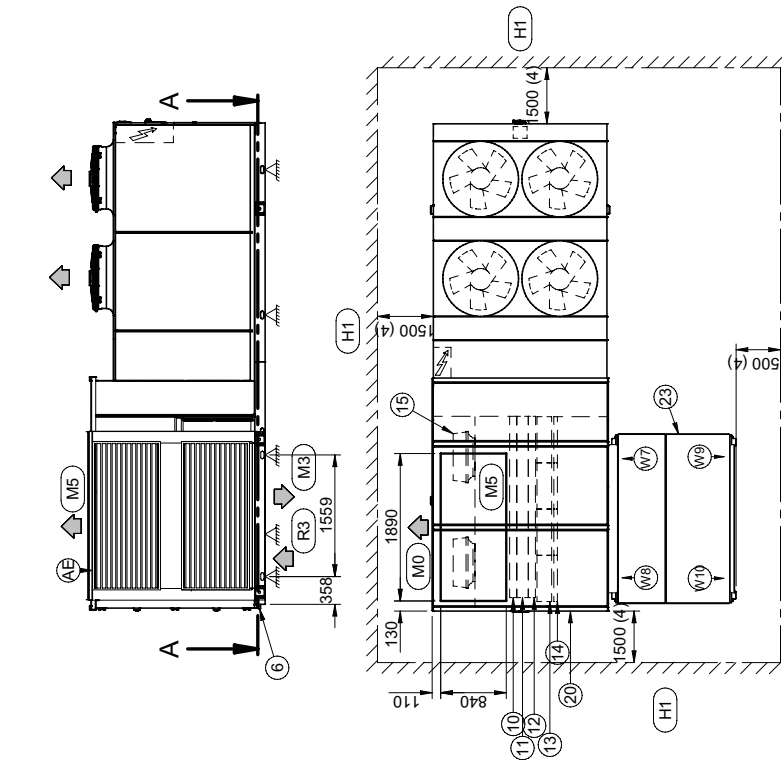

- 17. Liftn bracket (Removable)
- 20. Coil-filters-heaters inspection
- 23. Enthalpy wheel
- (R3) Downward air return
- (M0) Horizontal air supply
- (M3) Downward air supply
- (M5) Vertical air supply
- (AE) Outdoor air return (CBK / CBK-G / CCK-REVO version)
- (H) Wall with same height as unit on a maximum of three sides
- (V) Vibration mounts position

- 1. Compressor compartment
- 2. Electrical panel
- 3. Connector for keyboard or PC connection
- 4. Power input
- 5. Humidifier connections 1/2" M
- 6. Condensate drain with siphon
- 7. Functional clearances
- 8. Heating coil inlet H<sub>2</sub>O Ø 2"
- 9. Heating coil outlet H<sub>2</sub>O Ø 2"
- 10. Post-heating coil
- 11. Treatment coil
- 12. Heating coil H<sub>2</sub>O
- 13. Filters F7 - Filters F9 - Electrostatic filters
- 14. Filters G4
- 15. Electric fan (supply-return)
- 16. Discharge fan (CCK REVO version)

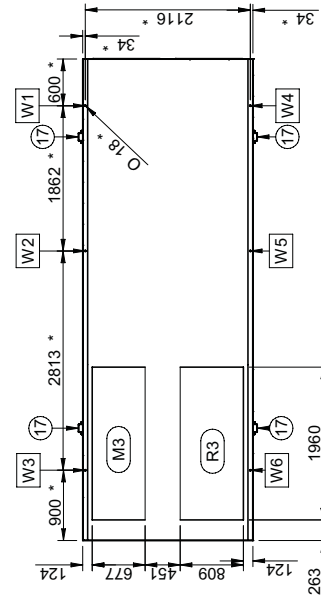

## SEZ A-A

### WEIGHT DISTRIBUTION - ROTARY RECOVERY MODULE

SIZE	60.4 - 70.4	80.4
W7 Support point	kg 176	kg 186,5
W8 Support point	kg 176	kg 186,5
W9 Support point	kg 176	kg 186,5
W10 Support point	kg 176	kg 186,5
Operation weight	kg 704	kg 746
Shipping weight	kg 704	kg 746

### WEIGHT DISTRIBUTION

SIZE	60.4	70.4	80.4
Configuration	CBK-G	CBK-G	CBK-G
W1 Support point	kg 413	kg 423	kg 423
W2 Support point	kg 495	kg 506	kg 506
W3 Support point	kg 451	kg 450	kg 450
W4 Support point	kg 409	kg 419	kg 419
W5 Support point	kg 474	kg 483	kg 483
W6 Support point	kg 363	kg 362	kg 362
Operation weight	kg 2605	kg 2643	kg 2643
Shipping weight	kg 2605	kg 2643	kg 2643

Optional accessories may result in a substantial variation of the weight show in table

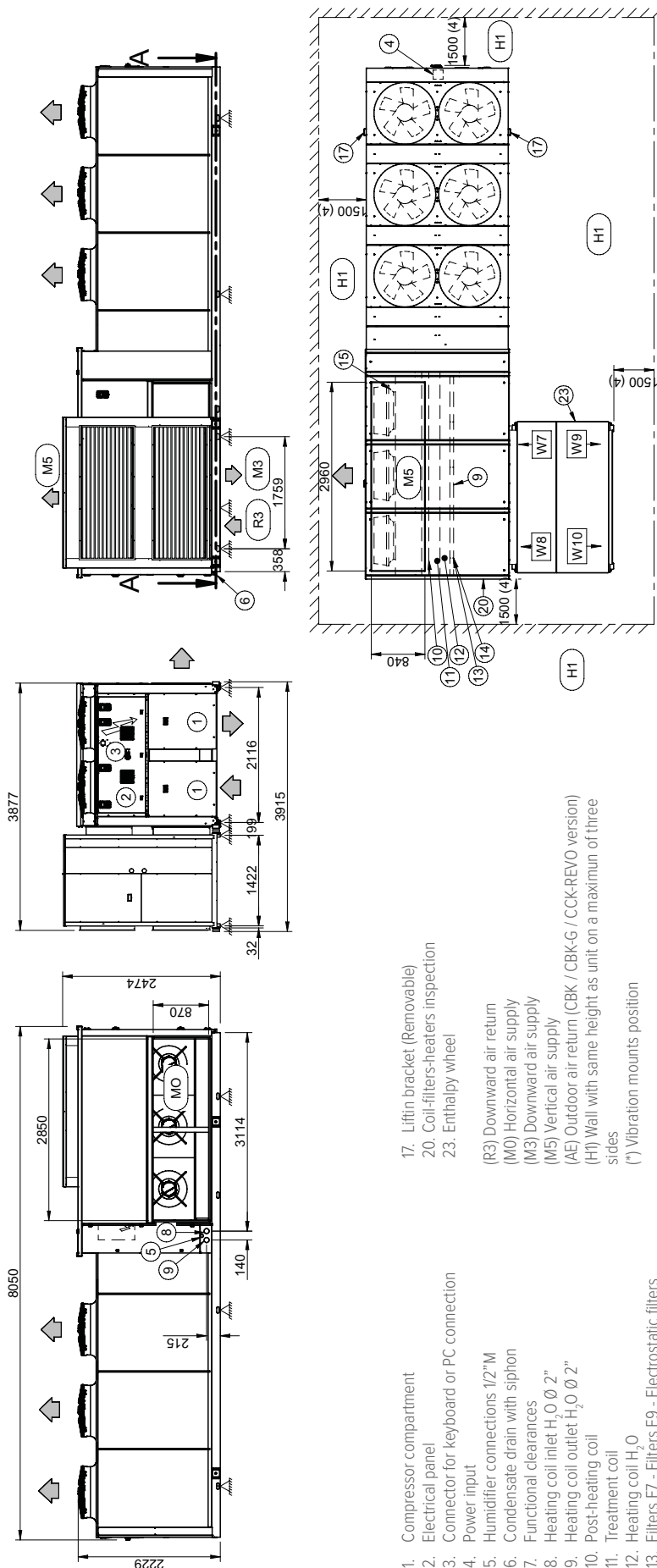

- 1. Compressor compartment
  - 2. Electrical panel
  - 3. Connector for keyboard or PC connection
  - 4. Power input
  - 5. Humidifier connections 1/2" M
  - 6. Condensate drain with siphon
  - 7. Functional clearances
  - 8. Heating coil inlet H<sub>2</sub>O Ø 2"
  - 9. Heating coil outlet H<sub>2</sub>O Ø 2"
  - 10. Post-heating coil
  - 11. Treatment coil
  - 12. Heating coil H<sub>2</sub>O
  - 13. Filters F7 - Filters F9 - Electrostatic filters
  - 14. Filters G4
  - 15. Electric fan (supply-return)
  - 16. Discharge fun (CCK REVO version)
  - 17. Lifin bracket (Removable)
  - 20. Coil-filters-heaters inspection
  - 23. Enthalpy wheel
- (R3) Downward air return  
(M0) Horizontal air supply  
(M3) Downward air supply  
(M5) Vertical air supply  
(AE) Outdoor air return (CBK / CBK-G / CCK-REVO version)  
(H1) Wall with same height as unit on a maximum of three sides
- (\*) Vibration mounts position

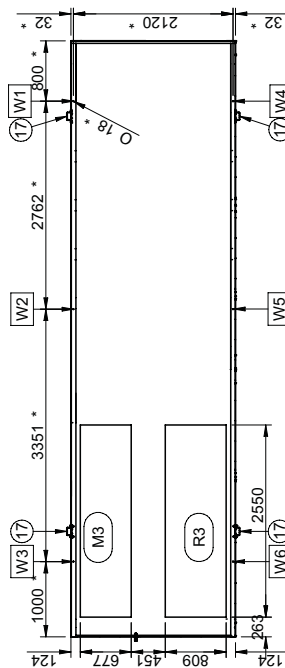

## WEIGHT DISTRIBUTION

SIZE	90.4	100.4	120.4
<b>Configuration</b>	<b>CBK-G</b>	<b>CBK-G</b>	<b>CBK-G</b>
W1 Support point	kg 569	kg 569	kg 640
W2 Support point	kg 686	kg 686	kg 734
W3 Support point	kg 582	kg 582	kg 576
W4 Support point	kg 541	kg 541	kg 598
W5 Support point	kg 691	kg 691	kg 740
W6 Support point	kg 467	kg 467	kg 461
Operation weight	kg 3536	kg 3536	kg 3750
Shipping weight	kg 3536	kg 3536	kg 3750

WEIGHT DISTRIBUTION - ROTARY RECOVERY MODU-LE	90	100.4 - 120.4
W7 Support point	kg 196	kg 204
W8 Support point	kg 196	kg 204
W9 Support point	kg 196	kg 204
W10 Support point	kg 196	kg 204
Operation weight	kg 784	kg 816
Shipping weight	kg 784	kg 816

Optional accessories may result in a substantial variation of the weight show in table

Page intentionally left blank

FOR OVER 30 YEARS WE HAVE BEEN OFFERING SOLUTIONS TO ENSURE SUSTAINABLE COMFORT AND THE WELL-BEING OF PEOPLE AND THE ENVIRONMENT

[www.clivet.com](http://www.clivet.com)

**MideaGroup**  
*Humanizing Technology*

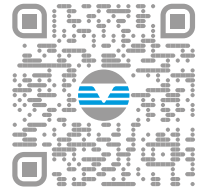

sales and service

CLIVETPack3 - CSRN-Y 60.4-120.4 - BT22N017GB-01



#### CLIVET S.p.A.

Via Camp Lonc 25, Z.I. Villapaiera 32032 - Feltre (BL) - Italy  
Tel. +39 0439 3131 - [info@clivet.it](mailto:info@clivet.it)

#### CLIVET GMBH

Hummelsbütteler Steindamm 84,  
22851 Norderstedt, Germany  
Tel. +49 40 325957-0 - [info.de@clivet.com](mailto:info.de@clivet.com)

#### Clivet Group UK LTD

Units F5 & F6 Railway Triangle,  
Portsmouth, Hampshire PO6 1TG  
Tel. +44 02392 381235 -  
[Enquiries@Clivetgroup.co.uk](mailto:Enquiries@Clivetgroup.co.uk)

#### CLIVET LLC

Office 508-511, Elektrozavodskaya st. 24,  
Moscow, Russian Federation, 107023  
Tel. +7495 6462009 - [info.ru@clivet.com](mailto:info.ru@clivet.com)

#### CLIVET MIDEAST FZCO

Dubai Silicon Oasis (DSO) Headquarter Building,  
Office EG-05, P.O Box-342009, Dubai, UAE  
Tel. +9714 3208499 - [info@clivet.ae](mailto:info@clivet.ae)

#### Clivet South East Europe

Jarušćica 9b  
10000, Zagreb, Croatia  
Tel. +3851 222 8784 - [info.see@clivet.com](mailto:info.see@clivet.com)

#### CLIVET France

10, rue du Fort de Saint Cyr - 78180 Montigny le  
Bretonneux, France  
[info.fr@clivet.com](mailto:info.fr@clivet.com)

#### Clivet Airconditioning Systems Pvt Ltd

Office No.501 & 502,5th Floor, Commercial -I,  
Kohinoor City, Old Premier Compound, Off LBS  
Marg, Kiroi Road, Kurla West, Mumbai  
Maharashtra 400070, India  
Tel. +91 22 30930200 - [sales.india@clivet.com](mailto:sales.india@clivet.com)