



*Packaged high efficiency
direct expansion Rooftop air
conditioner.
Full Inverter Technology*

CLIVETPack³ⁱ

CSRN-iY 20.2-56.4 RANGE

TECHNICAL BULLETIN



SIZE	20.2	28.2	40.4	56.4
COOLING CAPACITY KW	65,9	87,6	129	174
HEATING CAPACITY KW	61,0	80,1	126	167

Pagina

3	Features
5	Configurations
8	Unit configuration
12	Standard unit technical features
14	General technical data
22	Option compatibility
24	Standard functions
25	Accessories
37	Accessories separately supplied
41	Prerformance
49	Dimensional drawings



Clivet participates in the ECP Programme for "Rooftop".
Check ongoing validity of certificate on www.eurovent-certification.com

Features

CLIVETPack for medium attendance applications

The CSRN-iY units are high-efficiency stand-alone air conditioners designed for medium and large commercial areas with air renewal. They are specifically designed for medium crowded environments such as: shopping centers, shopping galleries, supermarkets, hypermarkets, railway stations, airports and industrial warehouses. The series features a double refrigeration circuit with Inverter compressors on each circuit.

This solution makes it possible to follow the trend of the thermal load even in mid-seasons, reaching very high seasonal performance and by far exceeding the minimum requirements set by the ErP 2021 regulations.

Clivet rooftop are Eurovent certified products

The ClivetPack³ⁱ series has the Eurovent Certified Performance quality mark, which means it has been tested strictly in accordance with the European standards.

This provides an additional guarantee for the customer: performances are certified and permit accurate analysis of the running costs "Total Life Cycle Cost".

Thanks to the single-block design of the unit, all of the plant engineering parts are contained inside the unit, already assembled and tested.

Four configurations available, from the full recirculation version, with minimum fresh air, to versions with renewal and energy recovery on the exhaust air. Each one can be integrated with a broad range of accessories that customise the product according to the application

- ✓ Double independent refrigerant circuit with inverter-controlled compressors for continuous modulation of the capacity provided, according to the thermal load of the building.
- ✓ Radial fans directly coupled to EC brushless motors (plug fans) allow to adjust the airflow according to the characteristics of the aerodynamic system. On both the supply and the exhaust section.
- ✓ Filtration of air in several stages, from the efficiency class G4 to classes of absolute filtration (electronic filters with iFD technology).
- ✓ UV-C lamps with active germicidal action against fungal spores, bacteria and viruses, for maximum air quality, effective against SARS-CoV-2.
- ✓ Innovative and patented REVO thermodynamic recovery.
- ✓ Energy recovery via enthalpy wheel available for CBK-G version
- ✓ Constant or variable control of the flow of supply air.
- ✓ Automatic and variable control of the amount of fresh air based on the actual occupants requirement, with air quality probe.
- ✓ Freecooling function when it is possible to use outdoor air directly to meet the internal loads.
- ✓ Great air distribution flexibility, with the option of connecting a roofcurb for supply and/or return from below.
- ✓ Summer dehumidification function with hot-gas post-heating to increase comfort even with high latent loads.
- ✓ Heating solutions that can be used together with or instead of the heat pump: electric heaters, hot water coil, modulating gas module with condensation technology.
- ✓ Humidification systems integrated in the unit.
- ✓ Possibility of connection to the main supervision systems with Modbus communication protocol supplied as standard.

All the accessories are cabled and supplied on board the unit unless specified otherwise.

Clivet's choice towards a green evolution

New R32 refrigerant

European regulation EC 517/2014 envisages a reduction in the use of HFC (F-gas) refrigerants with the aim of reducing their environmental impact, measured through the GWP (Global Warming Potential) parameter.

Clivet, which has always placed a strong focus on the development of technological solutions aimed at protecting the environment, introduces R32 refrigerant with a low GWP (675) on Rooftop units as well.

The environmental impact is thereby reduced by up to 80% not only thanks to the low GWP of R32, but also thanks to the reduction and optimisation of the refrigerant charge ensured through the careful design of each individual component.

The use of this A2L refrigerant (mildly flammable) is in line with the EN 378 standard, which defines its correct application based on the refrigerant charge and the surface of the rooms serviced.

Limit straight line calculated with room height of 6 m.

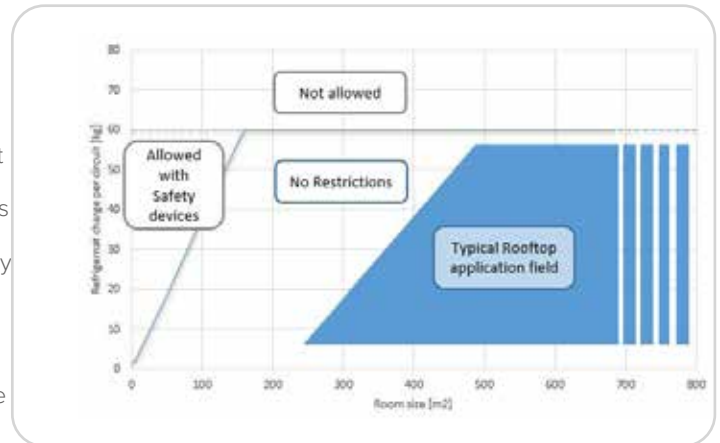

Full inverter Technology

The efficiency of energy-related products (ErP) is one of the pillars of the European programme for a sustainable economy, with the environment and people's quality of life in mind.

The high performance of the new CSRN-iY series helps achieve this goal through seasonal efficiency values up to 40% higher than the performance limits set by European regulations.

These important results are obtained thanks to the Full Inverter technology applied to the main components of the unit:

- A. Cooling circuit with inverter-controlled compressors
- B. Plug fans with brushless motor on the handling side
- C. Axial fans with brushless motor on the source side

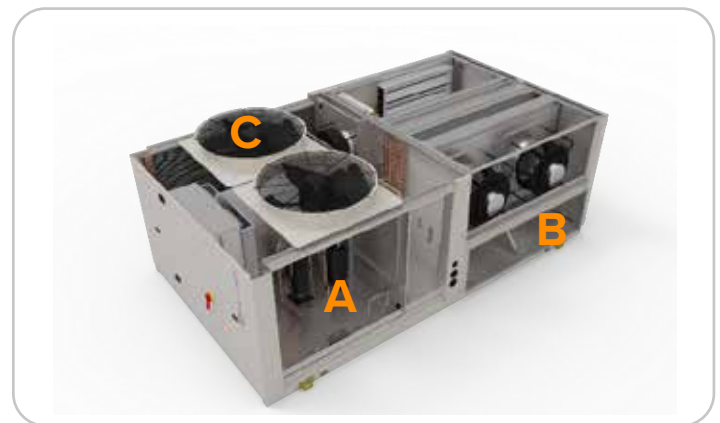

Configurations

CAK - Single fan section for full recirculation

For air conditioning applications only, without the need for fresh air renewal. The supply fan section provides the required static supply and return head.

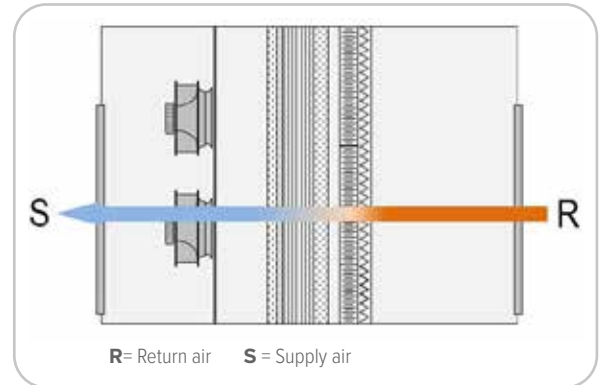

CBK - Single fan section for recirculation and fresh air

For applications where there is the need to keep the room in over-pressure, with the option of controlling a particular fresh air flow. As for the CAK configuration, the supply fan section provides the supply and return available static pressure

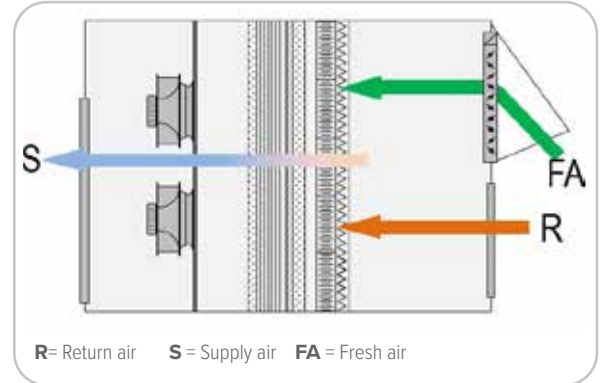

CBK-G - Single fan section for recirculation, renewal and exhaust

It ensures the renewal of ambient air and the simultaneous exhaust of stale air through a dedicated section. In addition to the configuration with modulating renewal damper and return from below (R3), the unit is fitted with a modulating recirculation damper and a gravity exhaust damper. The control logic automatically manages the renewal and exhaust of air directly on board the unit, activating Freecooling when possible up to 100% in proportion to the load to be fulfilled. The solution with gravity damper ensures the correct operation of the unit for installations with pressure drops on the return channel up to 50 Pa and is compatible only with the return section in position R3 (from the bottom). The following accessories are available for configuration CBK-G:

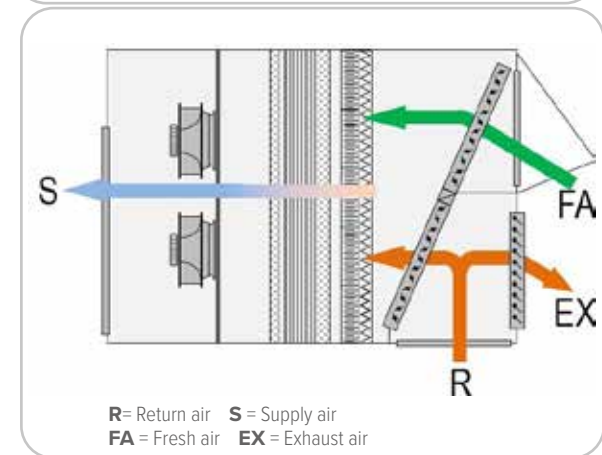

NSERG - Gravity exhaust air damper not required

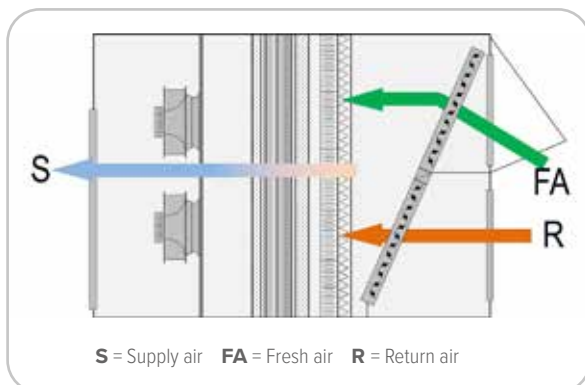

EWX - Enthalpy Wheel Energy Recovery Module

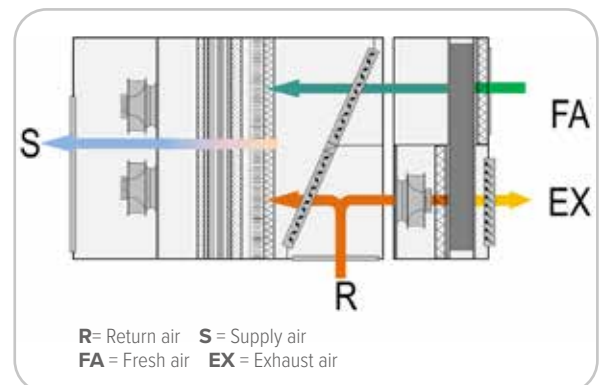

CCK-REVO - Dual ventilating section with renewal air and REVO thermodynamic recovery

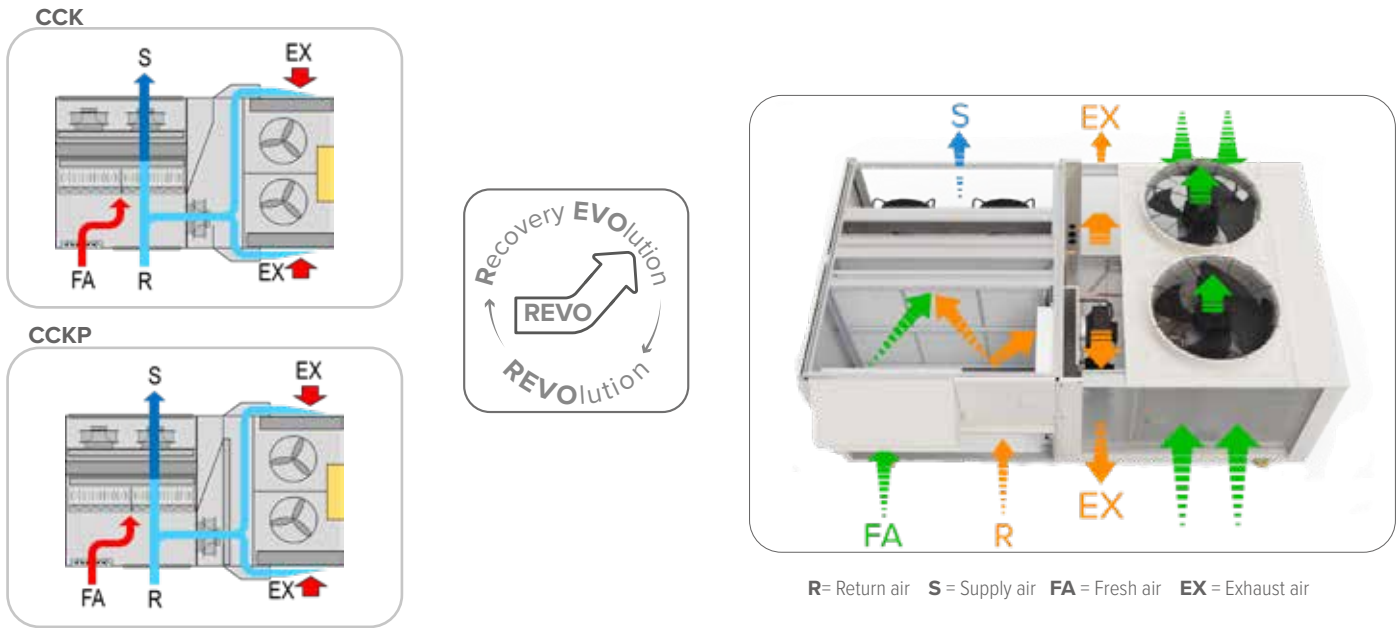

A new concept of thermodynamic recovery is introduced, which combines in a single version the benefits and performance of the previous CCK and CCKP configurations.

For applications with automatic air renewal and FREE-COOLING function control.

The unit is fitted with an exhaust section featuring an innovative and patented REVO thermodynamic recovery for exhaust air (Recovery EVOLution).

The innovative REVO recovery is always included in the CCK-REVO configuration and uses the technology of the refrigeration circuit with direct expansion.

The energy contained in the flow of exhaust air is recovered in a dedicated sector of the direct expansion source coil.

The amount of energy recovered can be easily measured, as in the case of static heat recovery.

Here below are the main benefits of energy recovery:

- Increased power delivered to the conditioned room.
- Increased overall efficiency of the unit for significant energy savings and guaranteed investment payback.
- Unit length reduced by 15%, ensuring a compact design and easy positioning.
- Refrigerant charge reduced by 30% compared to CCKP version, for a lower environmental impact of the unit and greater safety for users.
- Optimised industrialisation and reliability thanks to the removal of the additional recovery exchanger and consequent refrigerant circuit simplification.
- Elimination of higher electrical consumption for the ventilation of passive recovery devices, thereby reducing the total energy absorbed.
- In winter mode with heat pump operation, it reduces the formation of ice on the exchanger and therefore the defrosting frequency. The operation continuity and overall efficiency of the system are enhanced.
- Also effective for cooling operations, especially in continental and temperate climates where the output of traditional passive recovery devices is essentially negligible due to a low temperature and enthalpy difference between the outdoor and indoor environment.

Configurations

Automatic management of the air flow

Standard mode

The supply airflow is managed with 0-10V signal. The signal remains constant and keeps the fan speed consistent in all thermal load conditions and operating mode.

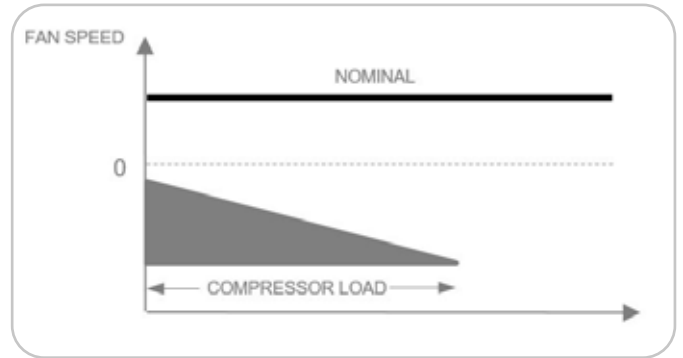

ECO mode (standard function)

The air flow supply remains constant at varied heat loads and is shutdown when the load is fulfilled.

To further increase the energy savings in this condition, it is also possible to set less demanding operation setpoints for the unit in respect to the standard mode.

This function is indicated to thermally maintain a served area when it is temporarily not used, which can for example occur at night.

The ECO mode can be activated:

- manually;
- automatically by means of the Clivet supervision System.

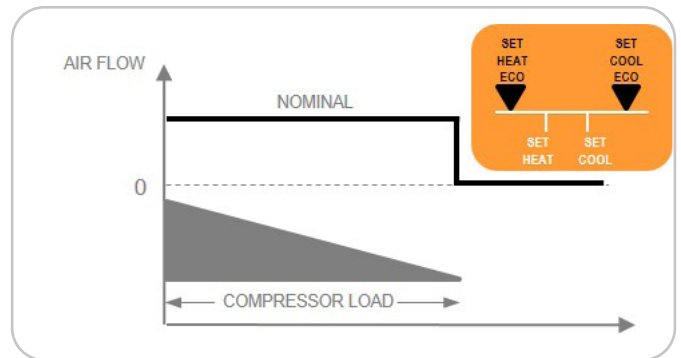

Constant air flow (PCOSM option)

Supply airflow rate remains constant even with the progressive fouling of the filters compensating for the increased pressure drops.

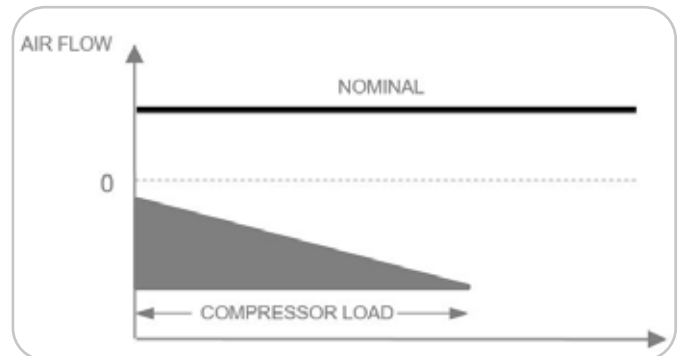

Variable airflow (PVAR option)

The air flow supply varies depending on the heat load, up to a minimum value compatible with the distribution system and the chosen air diffusion.

The ventilation remains active even when the load is fulfilled.

This option allows a important energy savings as:

- The movement of the air determines an annual energy consumption comparable or even greater than the compressors.
- The reduction of 20% of the flow generates a saving of 50% on energy absorbed by the ventilators.
- With a reduction of the flow equal to 40%, the saving for ventilation exceeds 70%.

The variable airflow can therefore lead to a saving of 30% on the overall electrical consumption of the unit.

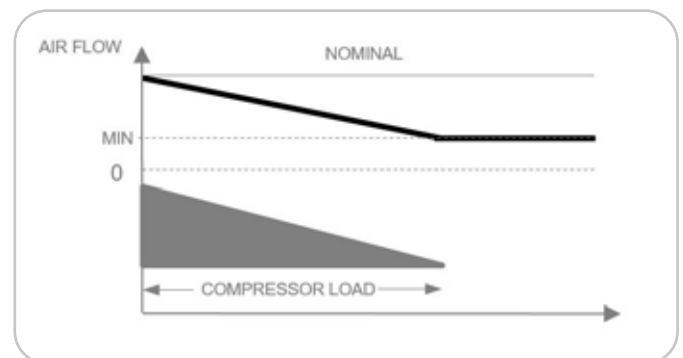

Moreover, the flow rate of the unit can be controlled as follows:

- PVARDP - Variable airflow with pressure probe on the uni
- PVMV - 4-20 mA signal for the supply airflow modulation
- BMS supervision system (not available with Standard mode management of the air flow)

Smart management of defrosts

The automatic defrosting cycles on surfaces of the external exchanger are managed in a predictive manner, which reduces both the frequency and the duration.

The on-board electronic regulation analyses not only the external conditions but also the changes of the evaporating pressure in the exchanger.

The standard defrosting cycle management involves the stop of the ventilation.

This reduces the time required for defrosting and prevents the introduction of too cold air in the served area, maintaining comfortable conditions for the users.

A specific design of the frame base of the exchanger promotes the outflow of condensation water during defrosting, thereby avoiding the formation of ice at the bottom of the external exchanger.



Ambient pressure control

The ambient pressure control device compares the return pressure with the external pressure and offsets any variations by acting on the outdoor air damper.

This way, the unit maintains the room at the relative pressure desired by the user, who can choose between overpressure, depression or equal pressure.

The ambient pressure control device is available and supplied as standard in the unit in the configuration with extraction and exhaust (Clivet reference CCK-REVO).

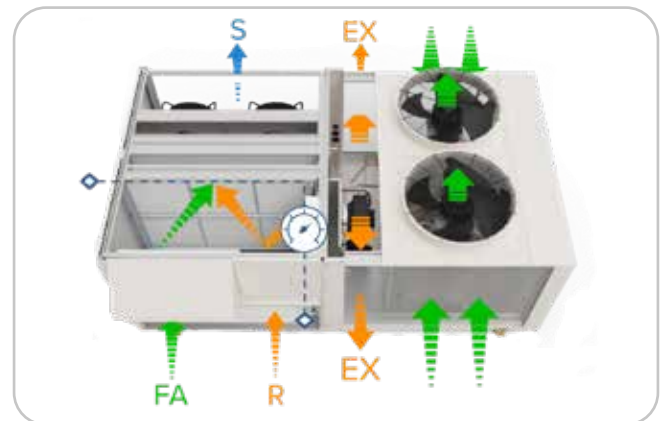

Advanced standard electronic control

CLIVETPack[®] is also equipped with everything that is required for the automatic control of ambient temperature and humidity and, through their comparison with the outdoor air conditions:

- selects the operating mode (heating or cooling);
- decides which and how many resources to activate depending on the distance from the determined set-point and return air temperature;
- manages the renewal air and the FREE-COOLING activation to maintain the comfort conditions.
- the user interface is standard supplied with the unit, it can be installed in the served area up to a distance of 50m with power supply directly from the unit.
- as an option it can be installed up to 300 m away by providing a separate power supply with a voltage of 12V d.c. (Provided by the Customer).

Collegamento dell'interfaccia utente con cavo schermato da 3 x 0.75 mm² for the communication, cable of 2 x 1 mm² for power supply

Some of its main functions:

- daily/weekly programming when the unit is to come on and go off;
- manually changing the operating mode (hot or cold) and/or the set-point;
- viewing alarms and the unit status;
- managing the operating parameters;
- it detects the temperature with its internal probe.

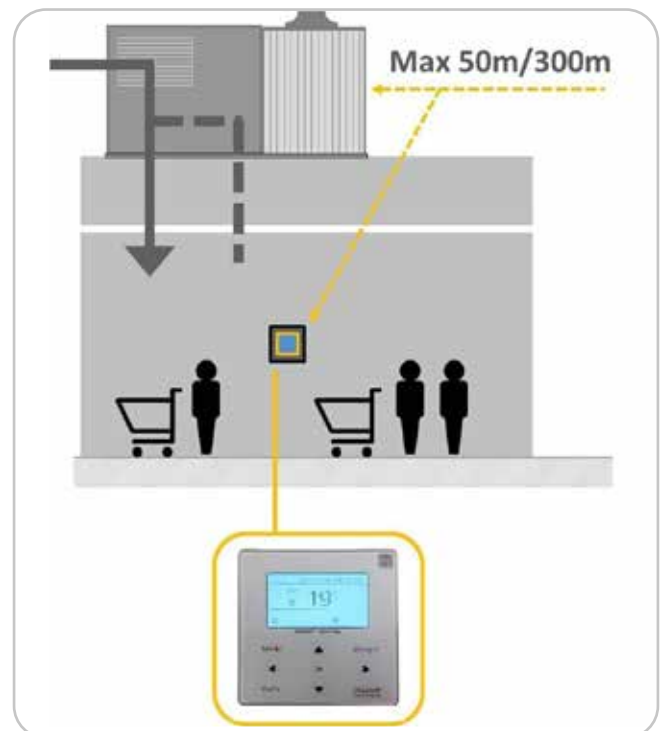

Unit configuration

Supply and return configurations

SIZES 20.2 - 28.2 - 40.4 - 56.4

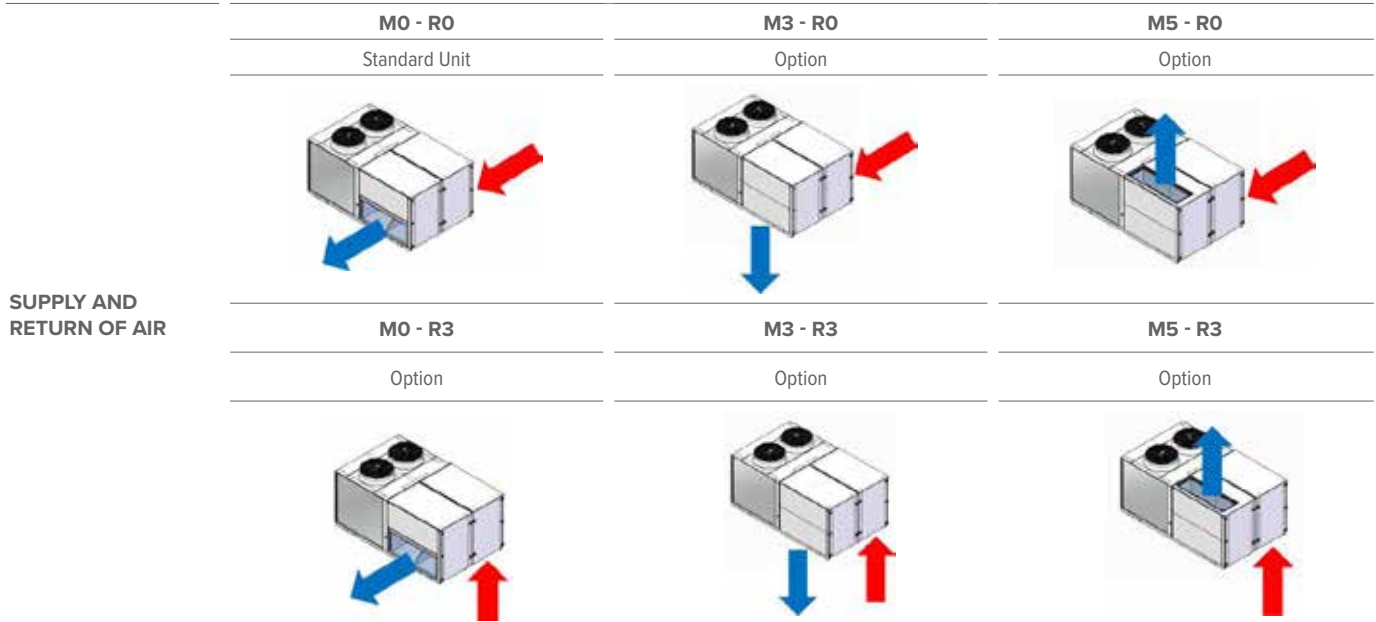

Filter nomenclature in accordance with EN ISO 16890

The classification of air filters is based on the ability to retain airborne particulate matter.

To make it possible and easier to select appropriate filters according to different applications, a new global standard for filtration has been recently introduced: EN ISO 16890.

It defines a new and alternative classification for air filters based on their ability to retain dispersed airborne particulate matter (PM10, PM2.5 and PM1) through new, more stringent and specific test methods.

The previous standards in force, such as EN 779-2012, ASHRAE 52.2 and other local standards, are thus unified for all countries worldwide.

Below, the correlation between the traditional nomenclature and the new standard for filters used in Clivet units. For easier reading, both names have been kept in the text.

1st stage of filtration (standard)	ISO 16890 Coarse 60%	G4
2st stage of filtration (optional)	ISO 16890 ePM1 55%	F7
2st stage of filtration (optional)	ISO 16890 ePM1 80%	F9
2st stage of filtration (optional)	ISO 16890 ePM1 90%	FIFD (electronic filter iFD)

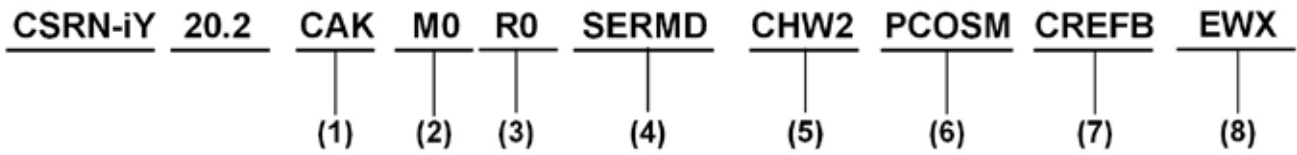

1. Configuration

CAK - Single fan section for full recirculation

CBK - Single fan section for recirculation and fresh air

CBK-G - Single fan section for recirculation, renewal and exhaust

CCK-REVO - Dual ventilating section with renewal air and REVO thermodynamic recovery

2. Air supply

M0 - Horizontal supply

M3 - Downflow supply

M5 - Upward supply air

3. Air return

R0 - Horizontal return

R3 - Downflow return

4. Outdoor air damper

SER - Manual outdoor air damper (std for CBK configuration)

SERM - Outdoor air on/off motorized damper (only configuration CBK)

SERMD - Modulating motorized fresh air shutter (opt for CBK configuration, std for CBK-G and CCK-REVO)

5. Auxiliary heating

not required (Std)

EH - Electric heaters

CHW2 - Two-rows hot water coil

GCX - Condensig gas heating module with modulating control

CHWER - Energy recovery from the food refrigeration

6. Airflow

not required (Std)

PCOSM - Supply constant airflow

PVAR - Variable airflow

PVARDP - Variable airflow with pressure probe on the uni

PVMV - 4-20mA signal for supply airflow modulation

7. External section fan

CREFB - ECOBREEZE external section fans consumption reduction device (Std)

8. Passive energy recovery

EWX - Enthalpy wheel energy recovery module (available only in configuration: CBK-G)

Unit configuration

How to choose the unit

Inverter technology makes it easier to select the unit.

Indeed, the high partialization range of delivered capacity ensures the unit constantly and continuously adapts to the specific heating and cooling requirements of the system.

Moreover, the unit can autonomously deliver higher capacity than the rated one when required. It is thus possible to determine the size of the unit according to the most frequent load situations, with the certainty of being able to meet load peaks for limited periods of time.

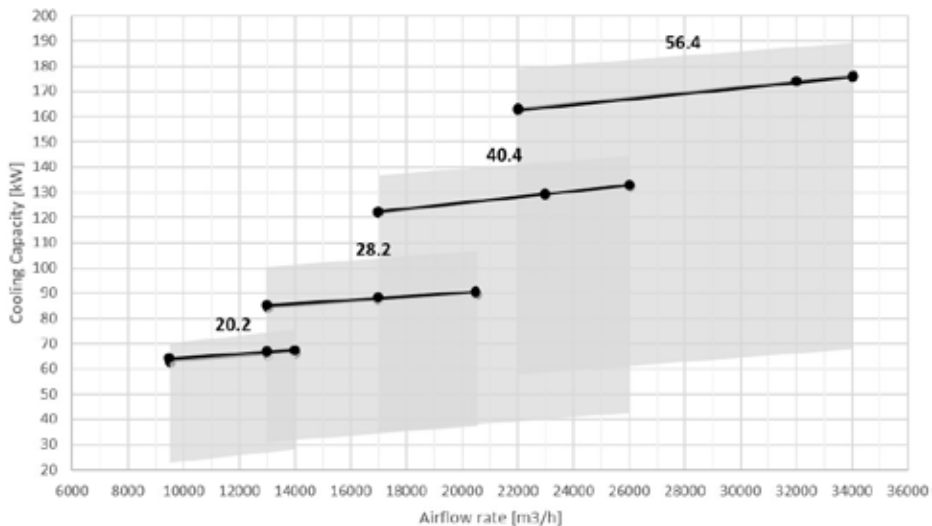

Performance referred to CCK-REVO configuration, Indoor air temp. 27°C D.B./19°C W.B., Entering external exchanger air temperature 35°C D.B./24°C W.B and 30% of external air

Compressor

20.2 - 28.2

Inverter-controlled hermetic rotary compressor (for size 20.2) and inverter-controlled hermetic scroll compressor (for size 28.2), fitted with a motor protection device for overheating, overcurrents and excessive temperatures of the supply gas. It is installed on antivibration mounts and comes with a full oil charge.

A guard heater with automatic insertion prevents the refrigerant from diluting the oil when the compressor stops.

There is a compressor installed on each refrigeration circuit.

40.4-56.4

Inverter-controlled hermetic tandem compressors: rotary (for size 40.4) and scroll (for size 56.4), fitted with a motor protection device for overheating, overcurrents and excessive temperatures of the supply gas. The tandem is installed on antivibration mounts and comes with a full oil charge.

A guard heater with automatic insertion prevents the refrigerant from diluting the oil when the compressor stops.

A tandem for the refrigeration circuit is installed

Structure

The support base is assembled with a painted galvanized steel frame. The internal structure is made of zinc - magnesium bent galvanized steel. The Zn-Mg alloy improves the characteristics in terms of corrosion resistance thanks to the galvanic protection typical of the Zinc-Magnesium combination.

Panelling

Sandwich panels in the air treatment section with dual walls in steel sheet metal with polyurethane insulation (40 kg/m³), thickness of outer sheet metal 6/10 mm galvanized and painted using polyester powders colour RAL 9001, polyurethane thickness 30 mm with thermal conductivity coefficient 0.022W/mK, thickness of internal sheet metal 5/10 mm hot galvanized. The panel are provided with a PVC profile for thermal insulation and a EPDM rubber gasket that ensures the hermetic seal.

All panelling can easily be removed to allow complete accessibility to internal components.

Internal exchanger

Direct expansion finned coil exchanger made with copper pipes placed on staggered rows mechanically expanded to better adhere to the fin collar. The fins are made from aluminium with a corrugated surface and adequately distanced to ensure the maximum heat exchange efficiency.

External exchanger

Direct expansion finned coil exchanger made with copper pipes placed on staggered rows mechanically expanded to better adhere to the fin collar. The fins are made from aluminium with a corrugated surface and adequately distanced to ensure the maximum heat exchange efficiency.

A correct dimensioning of the exchanger power supplies and the geometry of the structure at the base, prevents the formation of ice at the base of the heat exchanger during winter operation.

Fan

Internal section

Reverse-blade screwless plug-fan driven by EC brushless DC motors with direct coupling. No transmission sizing is needed.

External section

Helical fans with 4 profiled blades made of reinforced plastic, directly coupled to the brushless motor with electronic control, IP 54 execution. Fans are located in aerodynamically shaped structures to increase efficiency and minimize noise level, equipped with accident prevention steel guards.

Refrigeration circuit

Double refrigeration circuit, each with:

- refrigerant charge R32;
- safety high pressure switch,
- low pressure switch,
- filter dryer,
- electronic expansion valve;

- 4-way reverse cycle valve;
- liquid separator;
- low pressure safety valve;
- oil separator (only for size 40.4 e 56.4).

Filtration

Fresh air intake and ambient air return

Pleated filter for greater filtering surface, made of a galvanized sheet frame with a galvanized and electric-welded protective mesh, and regenerable filtering media made from polyester fibre sized with synthetic resins. ISO 16890 efficiency Coarse 60% (G4). Self-extinguishing type (flame resistant class 1 - DIN 53438).

Drain pan

Internal section

Condensate collection tray in thermoformed ABS, removable and sanitizable. Equipped with drain hose and UV-resistant silicone siphon.

Electrical panel

The capacity section includes:

- main door lock isolator switch;
- phase monitor;
- auxiliary circuit protection fuse;
- fan motor thermal protections of internal and extraction section;
- circuit breaker to protect auxiliary circuit and options.

The microprocessor control section includes:

- treated air temperature control;
- limit supply temperature probe;
- temperature set point and unit switch-on/off daily, weekly programmer;
- compressor timing and protection;
- self-diagnosis system with immediate display of the failure code;
- clean contacts for ON-OFF remote, cumulative alarm, fan mode, compressor mode, summer/winter mode;
- serial communication module for Modbus supervisor.

The wall-mounted electronic room control device includes:

- intuitive graphical interface retro lighted;
- modification of the temperature and humidity set point;
- unit On/Off and overload reset;
- heating/cooling operating mode manual change;
- display of operating data;
- display of alarms and failure code;
- display and modification of the operating parameters (password protected);
- selective key lock, unlocked with a password;
- room temperature sensor.

IoT integration (optional):

- Connectivity to the Clivet Eye IoT platform to avail of the cloud based services related to remote control, maintenance and optimization.
- Remote accessibility available via smartphone, tablet and PC by means of responsive interface.

Test

Unit manufactured to ISO 9001 standard and commissioned upon production completion.

Unit technical features

Options available

- VENH - High static pressure fans
- F7 - F7 high efficiency air filter (ISO 16890 ePM1 55%)
- F9 - F9 high efficiency air filter (ISO 16890 ePM1 80%)
- FIFD - Electronic filters with iFD technology (ISO 16890 ePM1 90%)
- PSAF - Differential pressure switch for dirty air filters
- HSE - Immersed electrodes steam humidifier
- PUE - External Humidifier management with 0-10V external signal
- PVAR - Variable airflow
- PCOSM - Supply constant airflow
- PVARDP - Variable airflow with pressure probe on the unit
- PVMV - 4-20mA signal for the supply airflow modulation
- FC - Thermal FREE-COOLING
- FCE - Enthalpy FREE-COOLING
- PAQC - Air quality probe for CO₂ rate check
- PAQCV - Air quality probe for CO₂ and VOC rate check
- PPAQC - External CO₂ signal management
- CPHG - Hot gas re-heating coil
- CSOND - Ambient humidity and temperature control with probes on board the unit
- CTT - Temperature control with thermostat
- EH - Electric heaters
- CHW2 - Two-rows hot water coil
- CHWER - Energy recovery from food refrigeration
- 2WVM - Modulating 2-way valve
- 3WVM - Modulating 3-way valve
- LTEMP1 - Application for low outdoor temperature
- EXFLOWC - Application in spaces with forced air exhaust at variable flow and exhaust section
- PCMO - Sandwich panels of the handling zone in M0 fire reaction class
- DESM - Smoke detector
- CONTA2 - Energy meter
- CHMET - Cooling and Heating Capacity Meter
- PGFC - Finned coil protection grilles

- PTCO - Set up for shipping via container
- MO - Horizontal air supply
- M3 - Downflow supply
- M5 - Upward supply air
- RO - Horizontal return
- R3 - Downward air return
- SERM - Outdoor air motorized on/off damper
- SER - Outdoor air damper manually set
- SERMD - Modulating motorised outdoor air damper
- NSERG - Gravity exhaust air damper: not required
- DML - Demand limit

Accessories separately supplied

- CLMX - Clivet Master System
- RCX - Roof curb
- AMRX - Rubber antivibration mounts
- AMRMX - Rubber antivibration mounts for unit and gas module
- AMRUVX - Rubber antivibration mounts for unit and UV-C lamp module
- AMREWX - Rubber antivibration mounts for unit and enthalpy wheel module
- IOTX - IoT industrial module for cloud based interoperability & services
- UVCX - UV-C germicidal lamps module
- MDMTX - Management of ambient temperature probes
- MDMTUX - Management of ambient temperature and humidity probes
- GCX - Condensig gas heating module with modulating control
- EWX - Enthalpy wheel energy recovery module

All the handling coils can be provided with coated aluminium - Fin Guard - copper/copper

Configuration with single fan section for recirculation, renewal and exhaust (CBK-G)

Same technical features as the structural configuration with a single fan section for all recirculation (CAK) and a single fan section for recirculation and fresh air (CBK), plus:

- **Modulating motorised outdoor air damper for renewal and FREE-COOLING**
- **Gravity exhaust air damper**

Double ventilation section configuration with air renewal and energy recovery via enthalpy wheel (EWX)

Same technical features as the structural configuration with a single fan section for recirculation, fresh air and exhaust air (CBK-G), plus:

- **Energy recovery of the exhaust air with the EWX enthalpy wheel**

Additional module envisaged on the ambient return section and fresh air intake.

Includes enthalpy wheel, G4 filters (ISO 16890 Coarse 50%) and reverse-blade screwless plug-fan ejection fans driven by EC brushless DC motors.

The module allows to recover the energy content of the exhaust air and reduce the thermal load required by the refrigeration circuit.

Configuration with dual ventilating section with fresh air and REVO thermodynamic recovery (CCK-REVO)

Same technical features as the structural configuration with a single fan section for all recirculation (CAK) and a single fan section for recirculation and fresh air (CBK), plus:

- **Modulating motorised outdoor air damper for renewal and FREE-COOLING**
- **Exhaust fan**

Reverse-blade screwless plug-fan driven by EC brushless DC motors with direct coupling

- **REVO exhaust air thermodynamic energy recovery (CCK-REVO)**

The energy contained in exhaust air is recovered on a portion of the external exchanger, through a dedicated ventilating section.

The purpose of the recovery is to improve the thermal level of the refrigerant fluid circulating in the exchanger, by varying in a useful way the temperature at which the condensation or evaporation of the operating fluid is completed.

As a result, the favourable air temperature on the source side increases the output and efficiency of the unit.

Clivet has filed a patent on this innovative recovery.

Performances - Standard airflow

SIZE			20.2		28.2		40.4		56.4	
OPERATION			NOM*	MAX**	NOM*	MAX**	NOM*	MAX**	NOM*	MAX**
COOLING										
Cooling capacity	1	kW	59,7	68,5	79,4	93,7	117	129	157	171
Sensible capacity	1	kW	50,6	54,8	66,9	73,5	90,4	96,1	124	130
Compressor power input	1	kW	18,5	26,5	22,2	34,4	38,7	50,3	50,7	64,9
EER	1	-	3,23	2,59	3,58	2,72	3,02	2,56	3,11	2,64
Cooling capacity (EN14511:2018)	5	kW	59,0		78,0		116,2		155,2	
EER (EN14511:2018)	5	-	2,86		2,88		2,67		2,73	
SEER	6		4,92		4,72		4,85		4,56	
η _{sc}	6	%	193,8		185,8		191,0		179,4	
Eurovent seasonal efficiency class			A		A		A		B	
Cooling capacity	2	kW	62,2	71,4	82,7	97,5	122	134	164	178
Sensible capacity	2	kW	53,0	57,2	70,0	76,5	94,4	100	129	135
Compressor power input	2	kW	18,7	27,0	22,3	34,8	39,2	51,1	51,2	65,5
EER	2	-	3,33	2,65	3,70	2,80	3,11	2,63	3,2	2,72
Cooling capacity	3	kW	65,9	75,7	87,6	103,0	129	142	174	189
Sensible capacity	3	kW	55,9	60,2	73,7	80,7	99,5	105	159	171
Compressor power input	3	kW	18,1	26,1	21,6	33,7	38	49,6	49,6	63,6
EER	3	-	3,63	2,89	4,05	3,06	3,4	2,87	3,5	2,97
HEATING										
Heating capacity	1	kW	57,5	78,5	76,1	101,0	119	155	160	201
Compressor power input	1	kW	13,7	24,0	17,2	29,5	32,6	54,7	41,9	67,2
COP	1	-	4,20	3,27	4,43	3,43	3,65	2,83	3,81	2,99
Heating capacity (EN14511:2018)	7	kW	58,0		76,8		119,7		162,3	
COP (EN14511:2018)	7	-	3,73		3,72		3,19		3,38	
SCOP	6		3,91		3,79		3,81		3,92	
η _{sh}	6	%	153,4		148,6		149,4		153,8	
Eurovent seasonal efficiency class			A+		A		A+		A+	
Heating capacity	2	kW	58,2	79,3	76,4	101,0	120	156	160	199
Compressor power input	2	kW	12,7	22,2	15,8	26,9	30,2	51	38,3	61,3
COP	2	-	4,58	3,56	4,85	3,74	3,97	3,07	4,17	3,25
Heating capacity	3	kW	61,0	83,1	80,1	105,0	126	164	167	209
Compressor power input	3	kW	12,6	22,1	15,7	26,7	30,1	50,7	38	61
COP	3	-	4,84	3,76	5,11	3,94	4,18	3,23	4,4	3,43
Recovery efficiency REVO	4	%	82	86	81	83	80	86	82	87

II The Product is compliant with the Erp (Energy Related Products) European Directive. It includes the Commission delegated Regulation (EU) No 2016/2281, also known as Ecodesign Lot21.

Contains fluorinated greenhouse gases (GWP 675)

Performances in cooling: Indoor air temp. 27°C D.B./19°C W.B., Entering external exchanger air temperature 35°C D.B./24°C W.B., EER referred only to compressors

Performance in Heating: Indoor air temp. 20°C D.B./12°C W.B., entering air to the external exchanger 7°C D.B./6°C W.B. COP referred only to compressors

1. Full recirculation performance
2. Performance with 30% outdoor air
3. Performance with 30% outdoor air, including energy recovery on exhaust air
4. Energy recovery efficiency determined on exhaust air. Indoor temperature 20°C DB/12°C WB, outdoor temperature 7°C DB/6°C WB
5. Full recirculation capacity according to EN 14511-2018, indoor air temperature 27°C DB/19°C WB; outdoor temperature 35°C. EER in accordance with EN 14511-2018
6. Data calculated in compliance with EN 14825:2018.
7. Full recirculation capacity according to EN 14511-2018, indoor air temperature 20°C; outdoor temperature 7°C DB/6°C WB COP in accordance with EN 14511-2018

* NOM = data referring to units in operation with inverter frequency optimised for this application.

** MAX = data referring to units in operation with maximum allowed inverter frequency

General technical data

Construction - Standard airflow

SIZE			20.2	28.2	40.4	56.4	
COMPRESSOR							
Type of compressors	1		ROT	SCROLL	ROT	SCROLL	
No. of compressors		No.	2	2	4	4	
Refrigeration circuits		No.	2	2	2	2	
Control capacity		%	20-100%	20-100%	20-100%	20-100%	
Refrigerant charge (C1)	CAK/CBK/CBK-G	2	kg	8,0	9,0	19	21
Refrigerant charge (C2)		2	kg	8,0	9,0	19	21
Refrigerant charge (C1)	CCK-REVO	2	kg	9,5	11	20	22
Refrigerant charge (C2)		2	kg	9,5	11	20	22
AIR HANDLING SECTION FANS (SUPPLY)							
Type of supply fan/motor	3		RAD/EC	RAD/EC	RAD/EC	RAD/EC	
Fan diameter		mm	630	560	630	560	
No. of supply fans		No.	1	2	2	3	
Supply airflow		m ³ /h	13000	17000	23000	32000	
Installed unit power		kW	2,38	2,90	2,38	2,90	
Max. static pressure supply fan	4	Pa	330	450	410	300	
Installed unit power	(VENH opt)		kW	3,82	3,50	3,82	3,50
Max. static pressure supply fan		4	Pa	630	810	690	645
FANS (EXHAUST) ONLY CONFIGURATION CBK-G + EWX							
Type of fans/motor			RAD/EC	RAD/EC	RAD/EC	RAD/EC	
No. of fans			2	2	2	2	
Installed unit power			2,6	2,6	2,6	2,6	
FANS (EXHAUST) ONLY CONFIGURATION CCK-REVO							
Type of fans/motor	3		RAD/EC	RAD/EC	RAD/EC	RAD/EC	
No. of fans		No.	1	2	2	2	
Installed unit power		kW	3,65	1,32	3,65	2,38	
EXTERNAL SECTION FANS							
Type of fans/motor	5		AXIAL/EC	AXIAL/EC	AXIAL/EC	AXIAL/EC	
Fan diameter		mm	750	890	890	750	
No. of fans		No.	2	2	2	4	
Airflow		m ³ /h	26000	42000	50000	60000	
Installed unit power		kW	0,92	1,5	1,5	0,92	
CONNECTIONS							
Condensate drain		mm	32	32	32	32	
POWER SUPPLY							
Standard power supply		V	400/3~/50	400/3~/50	400/3~/50	400/3~/50	

1. ROT = Rotary compressor SCROLL= scroll compressor
2. Indicative values for standard units with possible +/-10% variation. The actual data are indicated on the label of the unit
3. RAD = Radial fan - EC = Electronically Commutated
4. Net pressure available to overcome flow and return pressure losses
5. AXIAL = Axial fan - EC = Electronically Commutated

Fan performances

Size 20.2 Standard fans

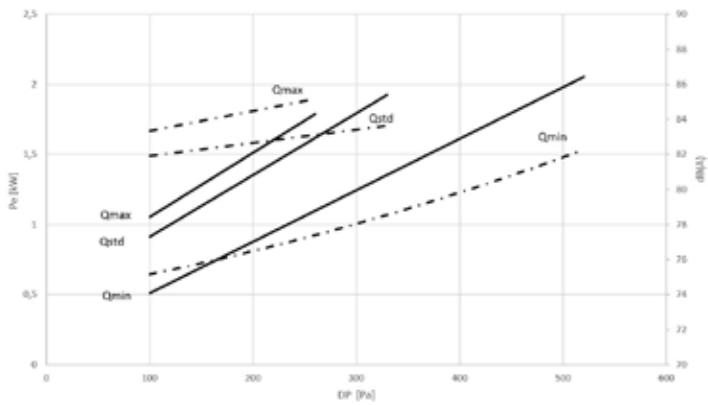

High static pressure fans

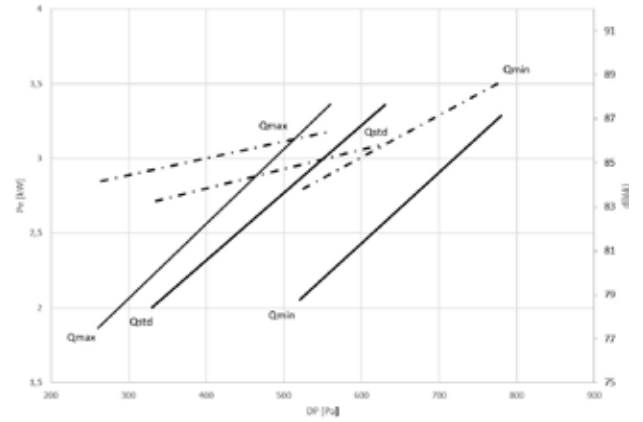

Size 28.2 Standard fans

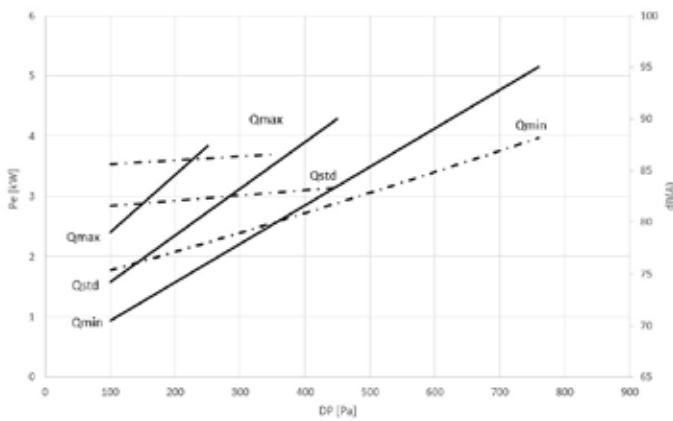

High static pressure fans

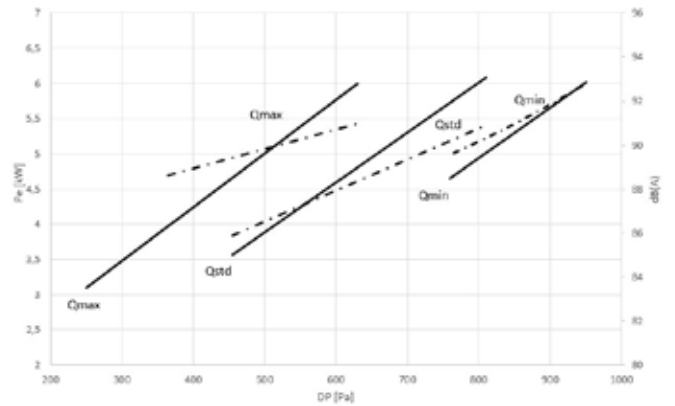

Size 40.4 Standard fans

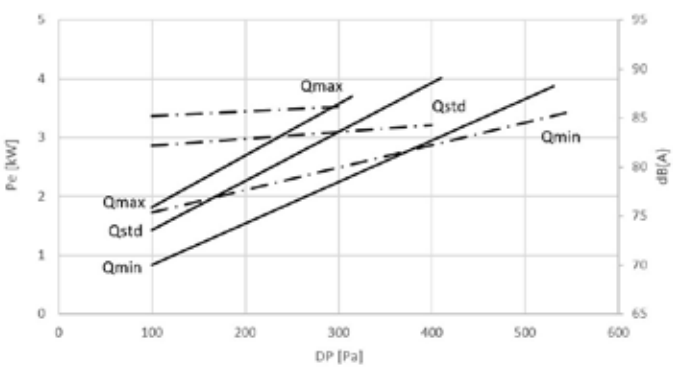

High static pressure fans

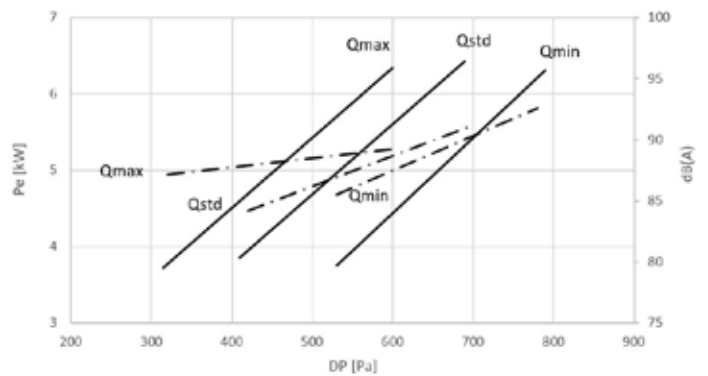

General technical data

Size 56.4 Standard fans

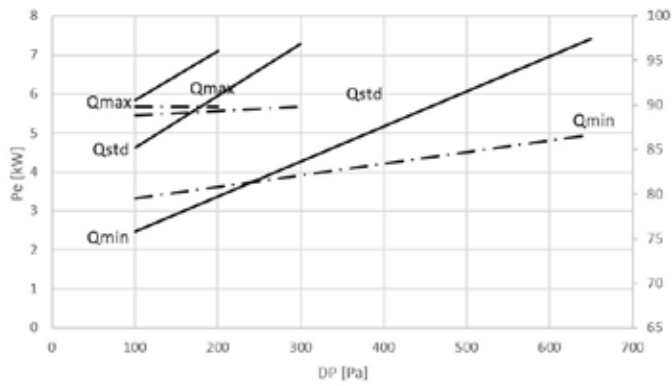

High static pressure fans

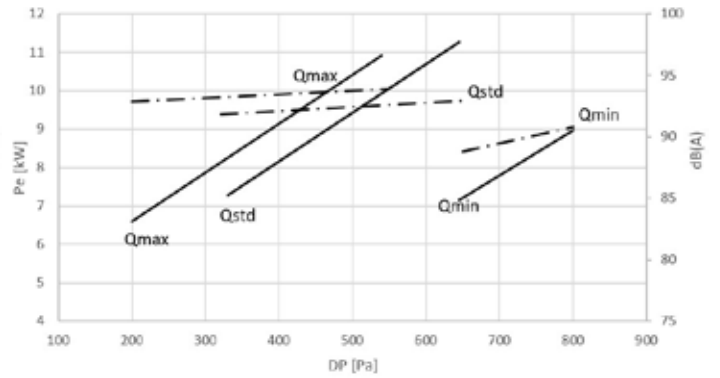

Size 20.2 - 28.2- 40.4 - 56.4 Exhaust fan

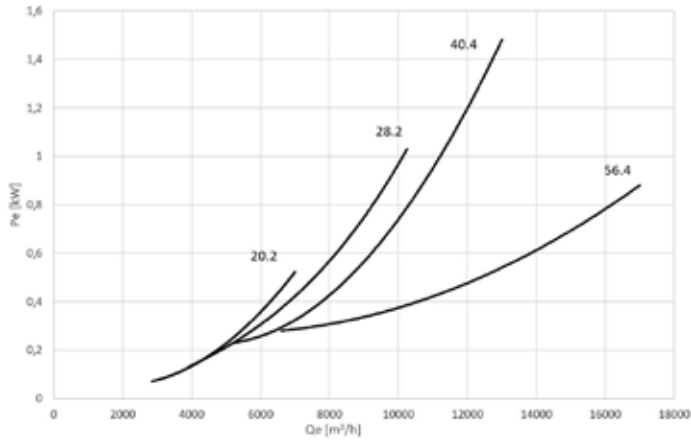

Size		20.2	28.2	40.4	56.4
Qmin	m³/h	9.500	13.000	17.000	22.000
Qstd	m³/h	13.000	17.000	23.000	32.000
Qmax	m³/h	14.000	20.500	26.000	34.000

- Qe = Extracted air flow rate
- = Pe = Total absorbed electrical power
- - - = dB(A) = Sound Power at the supply section

The performance takes into account the internal pressure drops of the std unit in CAK configuration (treatment coil pressure drops, standard filters, etc.). To determine the required performance of the supply fans, the pressure drops of any accessories must be added to the desired available static pressure.

Sound level - Nominal operation

SIZE	Sound power level (dB)								Sound power level dB(A)	Sound pressure level dB(A)
	Octave band (Hz)									
	63	125	250	500	1000	2000	4000	8000		
20.2	61	75	72	76	80	86	72	64	88	70
28.2	75	79	82	82	85	85	76	68	89	70
40.4	82	81	78	79	83	83	76	71	88	69
56.4	72	74	78	80	86	84	78	65	90	70

Sound levels - Maximum conditions

SIZE	Sound power level (dB)								Sound power level dB(A)	Sound pressure level dB(A)
	Octave band (Hz)									
	63	125	250	500	1000	2000	4000	8000		
20.2	72	81	76	80	85	85	77	68	90	72
28.2	74	83	78	82	87	87	79	70	91	72
40.4	72	77	80	81	85	85	78	73	90	71
56.4	74	74	77	83	87	87	80	68	92	72

Sound level - Silent mode

SIZE	Sound power level (dB)								Sound power level dB(A)	Sound pressure level dB(A)
	Octave band (Hz)									
	63	125	250	500	1000	2000	4000	8000		
20.2	62	75	79	80	84	82	75	66	86	68
28.2	62	75	79	80	84	82	75	66	88	69
40.4	69	76	75	78	82	80	74	70	86	68
56.4	75	73	73	81	84	82	78	65	88	68

Sound level - Supersilent mode

SIZE	Sound power level (dB)								Sound power level dB(A)	Sound pressure level dB(A)
	Octave band (Hz)									
	63	125	250	500	1000	2000	4000	8000		
20.2	46	68	68	74	76	84	68	61	85	67
28.2	59	73	78	79	81	80	73	64	86	67
40.4	67	75	73	77	79	79	72	67	84	65
56.4	65	70	70	81	79	77	80	63	86	66

Correction factors Silent and Supersilent performance

	20.2		28.2		40.4		56.4	
	Silent	Supersilent	Silent	Supersilent	Silent	Supersilent	Silent	Supersilent
Capacity C/H	0,94	0,87	0,98	0,93	0,94	0,87	0,97	0,91
Power input C/H	1,04	0,90	1,09	0,91	1,04	0,90	1,10	0,90
EER / COP	0,90	0,97	0,90	1,02	0,90	0,97	0,88	1,01

The sound levels are referred to unit operating at nominal load in nominal conditions. The sound pressure level is referred at a distance of 1 m from the ducted unit surface operating in free field conditions. External static pressure 50 Pa. (standard UNI EN ISO 9614-1)

Measurements are carried out accordingly to UNI EN ISO 9614-1, as required by Eurovent Certification EUROVENT 8/1. It requires a 2 dB(A) tolerance on sound power level, only acoustic value to be certified.

Please note that when the unit is installed in conditions different from nominal test conditions (e.g. near walls or obstacles in general), the sound levels may undergo substantial variations.

Specific sound performance according to different configuration are available on demand. data referring to units in operation with inverter frequency optimised for this application.

Sound levels referred to ESP as per EN 14511:2018

SIZE	20.2	28.2	40.4	56.4
Sound power with casing	dB(A)			
	88	89	88	90
Available static pressure	Pa			
	200	200	300	350

Data referred to nominal air flow rate.

Measurements are carried out accordingly to UNI EN ISO 9614-1, as required by Eurovent Certification EUROVENT 8/1. It requires a 2 dB(A) tolerance on sound power level, only acoustic value to be certified.

General technical data

Pressure drops of optional components

The value of static pressure available on the supply and return duct is obtained by subtracting from the available net maximum pressure (see general table of technical data) the pressure drops of any accessories.

SIZE		20.2	28.2	40.4	56.4
CHW2 - Two-rows hot water coil	Pa	31	40	40	41
CPHG - Hot gas re-heating coil	Pa	20	16	18	20
CHWER - Energy recovery from the food refrigeration	Pa	56	60	61	65
F7 - F7 high efficiency air filter	1 Pa	181	165	175	167
F9 - F9 high efficiency air filter	1 Pa	221	205	215	207
FIFD - Electronic filters with iFD technology	1 Pa	124	86	96	93
UVCX - UV-C germicidal lamps module	Pa	70	69	100	106
EWX - Enthalpy Wheel Energy Recovery Module.	1,2 Pa	120	140	90	130
GCX - Condensig gas heating module	Pa	70	69	70	70

1. Pressure drops with filters with average dirtiness
2. Pressure drops referring to 30% of outdoor air compared to a standard air flow

The values shown are to be considered approximate for units operating power in normal use with standard air flow rate.

Electrical data

Configuration with direct ductable return (CAK) and outdoor air recirculation (CBK/CBK-G)

SIZE		20.2	28.2	40.4	56.4
F.L.A. - FULL LOAD CURRENT AT MAX ADMISSIBLE CONDITIONS					
F.L.A. - Total	A	57,9	98,2	112,7	189,6
F.L.I. - FULL LOAD POWER INPUT AT MAX ADMISSIBLE CONDITIONS					
F.L.I. - Total	kW	34,1	46,4	65,2	89,1
M.I.C. MAXIMUM INRUSH CURRENT					
M.I.C. - Value	A	57,9	98,2	112,7	189,6

It1

Configuration with recirculation, exhaust and fresh air and recovery (CCK-REVO)

SIZE		20.2	28.2	40.4	56.4
F.L.A. - FULL LOAD CURRENT AT MAX ADMISSIBLE CONDITIONS					
F.L.A. - Total	A	64,2	102,9	125,3	199,0
F.L.I. - FULL LOAD POWER INPUT AT MAX ADMISSIBLE CONDITIONS					
F.L.I. - Total	kW	38,1	49,3	73,3	95,2
M.I.C. MAXIMUM INRUSH CURRENT					
M.I.C. - Value	A	64,2	102,9	125,3	199,0

Data refer to standard units. Power supply: 400/3~/50 Hz. Voltage variation: max. +/-10%
Voltage unbalance between phases: max 2 %

1. Values not including the accessories. To obtain the value of F.L.A. including accessories, add to the total F.L.A. value that of any accessories (see electrical data of accessories)
2. Values not including the accessories. To obtain the value of F.L.I. including accessories, add to the total F.L.I. value that of any accessories (see electrical data of accessories)

Electrical input of optional components

To obtain the electrical input of the unit including accessories, add the standard data in Electrical Data table to those for the selected accessories.

SIZE		20.2	28.2	40.4	56.4	
F.L.A. ABSORBED CURRENT						
F.L.A. EH12 - 9 kW electric elements	A	13,0	-	-	-	
F.L.A. EH14 - 12 kW electric elements	A	17,3	17,3	-	-	
F.L.A. EH17 - 18 kW electric elements	A	26,0	26,0	26,0	-	
F.L.A. EH20 - 24 kW electric elements	A	-	34,6	34,6	34,6	
F.L.A. EH24 - 36 kW electric elements	A	-	-	52,0	52,0	
F.L.A. EH28 - 49 kW electric elements	A	-	-	-	69,3	
F.L.A. HSE3 - Immersed electrodes steam humidifier of 3 kg/h	A	3,2	3,2	-	-	
F.L.A. HSE5 - Immersed electrodes steam humidifier of 5 kg/h	A	8,7	8,7	-	-	
F.L.A. HSE8 - Immersed electrodes steam humidifier of 8 kg/h	A	8,7	8,7	8,7	8,7	
F.L.A. HSE9 - Immersed electrodes steam humidifier of 15 kg/h	A	16,2	16,2	16,2	16,2	
F.L.A. LTEMP1 - Application for low outdoor temperature	A	1,0	1,0	1,0	1,0	
F.L.A. VENH - High static pressure fans	1	A	7,0	11,4	14,0	17,1
F.L.A. EWX - Enthalpy wheel energy recovery module	A	12,4	12,4	12,8	12,8	
F.L.I. POWER INPUT						
F.L.I. EH12 - 9 kW electric elements	kW	9,0	-	-	-	
F.L.I. EH14 - 12 kW electric elements	kW	12,0	12,0	-	-	
F.L.I. EH17 - 18 kW electric elements	kW	18,0	18,0	18,0	-	
F.L.I. EH20 - 24 kW electric elements	kW	-	24,0	24,0	24,0	
F.L.I. EH24 - 36 kW electric elements	kW	-	-	36,0	36,0	
F.L.I. EH28 - 49 kW electric elements	kW	-	-	-	48,0	
F.L.I. HSE3 - Immersed electrodes steam humidifier of 3 kg/h	kW	2,3	2,3	-	-	
F.L.I. HSE5 - Immersed electrodes steam humidifier of 5 kg/h	kW	6,0	6,0	-	-	
F.L.I. HSE8 - Immersed electrodes steam humidifier of 8 kg/h	kW	6,0	6,0	6,0	6,0	
F.L.I. HSE9 - Immersed electrodes steam humidifier of 15 kg/h	kW	11,3	11,3	11,3	11,3	
F.L.I. LTEMP1 - Application for low outdoor temperature	kW	0,3	0,3	0,3	0,3	
F.L.I. VENH - High static pressure fans	1	kW	4,5	7,4	9,0	11,1
F.L.I. EWX - Enthalpy wheel energy recovery module	kW	7,9	7,9	8,2	8,2	

1. The absorption value that needs to be added on takes into account the difference between the optional high head fans and the standard fans.

General technical data

Operating range (Cooling)

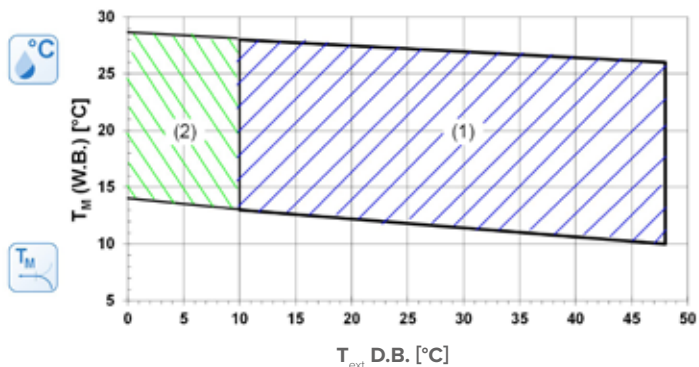

The limits are meant as an indication and they have been calculated by considering:

- general and non specific sizes,
- standard airflow,
- non-critical positioning of the unit and correct operating and maintenance of the unit,
- operating at full load

To verify the operation field of the operating units with percentages of outdoor air, always calculate the T_m mixing temperature at the internal heat exchanger input.

T_m = Inlet air temperature in the internal exchanger wet bulb temperature (W.B.=WET BULB)

T_{ext} = External exchanger inlet air temperature measured temperature with wet bulb (W.B.=WET BULB)

Within its operating range, the unit can work at a partialized load to maximise energy efficiency

1. Standard unit operating range
2. Operating range of the unit in FREE-COOLING mode (CBK-G and CCK-REVO versions)

WET BULB TEMPERATURE - EXAMPLE

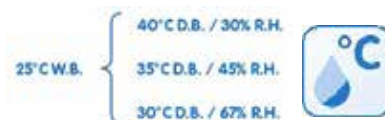

Operating range (Heating)

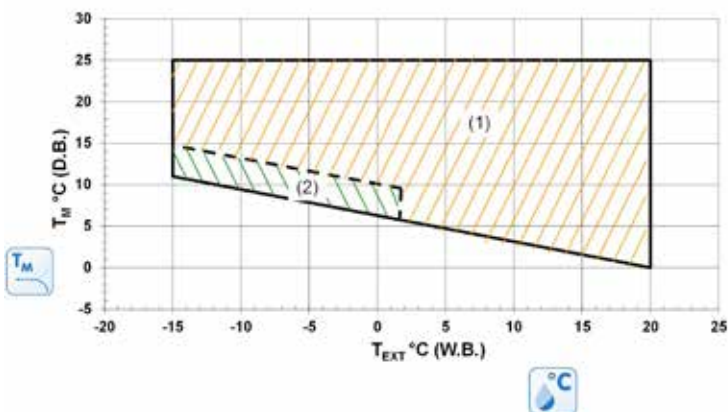

The limits are meant as an indication and they have been calculated by considering:

- general and non specific sizes,
- standard airflow,
- non-critical positioning of the unit and correct operating and maintenance of the unit,
- operating at full load

To verify the operation field of the operating units with percentages of outdoor air, always calculate the T_m mixing temperature at the internal heat exchanger input.

T_m = Inlet air temperature in the internal exchanger measured temperature with wet bulb (W.B.=WET BULB)

T_{ext} = External exchanger inlet air temperature wet bulb temperature (W.B.=WET BULB)

Within its operating range, the unit can work at a partialized load to maximise energy efficiency

1. Standard operating range
2. Range in which the unit operation is allowed only for a limited period (max 1 hour)

In prolonged heat pump mode with an ambient temperature below 6°C, the unit carries out defrosting cycles with cycle inversion to eliminate the ice that forms on the surfaces of the external exchanger. Moreover, in the event of negative temperatures, it is important to promote the evacuation of water produced by defrosting to avoid the accumulation of ice near the base of the unit. Ensure this does not pose a hazard to property or persons.

With outdoor air temperatures between -10°C and -25°C, the following options will be required:

- Hot water coil / Gas heating module
- Application for low outdoor temperature

Option compatibility

NAME	DESCRIPTION	CAK	CBK	CBK-G	CCK-REVO
VERSION					
FC	Thermal FREE-COOLING	-	-	√	√
FCE	Enthalpic FREE-COOLING	-	-	0	0
REVO	Exhaust air thermodynamic energy recovery (CCK-REVO)	-	-	-	√
CONFIGURATIONS					
CREFB	ECOBREEZE type outdoor section fans consumption reduction device	√	√	√	√
CHW2	Two-rows hot water coil	0	0	0	0
CHWER	Energy recovery from food refrigeration	0	0	0	0
3WVM	Modulating 3-way valve	0	0	0	0
2WVM	Modulating 2-way valve	0	0	0	0
EH	Electric heaters	0	0	0	0
GCX	Condensing gas heating module with modulating control	◇	◇	◇	◇
EWX	Enthalpy wheel energy recovery module	-	-	◇	-
AMRX	Rubber antivibration mounts	◇	◇	◇	◇
AMRMX	Rubber antivibration mounts for unit and gas module	◇	◇	◇	◇
AMRUVX	Rubber antivibration mounts for unit and UV-C lamp module	◇	◇	◇	◇
AMREWX	Rubber antivibration mounts for unit and enthalpy wheel module	-	-	◇	-
RCX	Roof curb	◇	◇	◇	◇
PGFC	Finned coil protection grilles	0	0	0	0
PCMO	Sandwich panels of the handling zone in M0 fire reaction class	0	0	0	0
REFRIGERATION CIRCUIT					
CINV	Inverter compressor	√	√	√	√
EVE	Electronic expansion valve	√	√	√	√
CPHG	Hot gas re-heating coil	0	0	0	0
AERAUIC CIRCUIT					
MO	Front air outlet	√	√	√	√
M3	Downward air supply	0	0	0	0
M5	Upflow air supply	0	0	0	0
RO	Horizontal air return	√	√	0	√
R3	Downward air return	0	0	√	0
SERM	Outdoor air motorized on/off damper	-	0	-	-
SER	Manual outdoor air damper	-	√	-	-
SERMD	Modulating motorised outdoor air damper	-	0	√	√
SERG	Gravity exhaust air damper	-	-	√	-
NSERG	Gravity exhaust air damper: not required	-	-	0	-
VENH	High static pressure supply fan	0	0	0	0
PVAR	Variable airflow	0	0	0	0
PCOSM	Constant supply airflow	0	0	0	0
PVARDP	Variable airflow with pressure probe on the unit	0	0	0	0
PVMV	4-20mA signal for the supply airflow modulation	0	0	0	0
PAQC	Air quality probe for CO ₂ rate check	-	0	0	0
PAQCV	Air quality sensor for CO ₂ and VOC rate check	-	0	0	0
PPAQC	External CO ₂ signal management	-	0	0	0
FPG4	Pleated air filter class G4 (ISO 16890 Coarse 60%)	√	√	√	√
F7	High efficiency F7 air filter (ISO 16890 ePM1 55%)	0	0	0	0
F9	High efficiency F9 air filter (ISO 16890 ePM1 80%)	0	0	0	0
FIFD	Electronic filters with iFD technology (ISO 16890 ePM1 90%)	0	0	0	0
PSAF	Clogged filter differential pressure switch air side	0	0	0	0
HSE	Immersed electrodes steam humidifier	0	0	0	0
PUE	External Humidifier management with 0-10V signal	0	0	0	0
LTEMP1	Application for low outdoor temperature	0	0	0	0
EXFLOWC	Application in spaces with forced air exhaust at variable flow and exhaust section	-	-	-	0
UVCX	UV-C germicidal lamps module	◇	◇	◇	◇

√ Standard component

0 Optional component

◇ Accessory supplied separately (optional)

- Not available

Option compatibility

NAME	DESCRIPTION	CAK	CBK	CBK-G	CCK-REVO
ELECTRIC CIRCUIT					
CMSC9	Serial communication module for Modbus supervisor	√	√	√	√
CRC	Remote control with user interface	√	√	√	√
CTT	Temperature control with thermostat	0	0	0	0
CTEM	Ambient temperature control with probes on board the unit	√	√	√	√
CSOND	Ambient temperature and humidity control with built-in probes	0	0	0	0
MDMTX	Management of temperature ambient probes	◊	◊	◊	◊
MDMTUX	Management of temperature and humidity ambient probes	◊	◊	◊	◊
CLMX	Clivet Master System	◊	◊	◊	◊
IOTX	IoT industrial module for cloud based interoperability & services	◊	◊	◊	◊
PM	Phase monitor	√	√	√	√
DESM	Smoke detector	0	0	0	0
CONTA2	Energy meter	0	0	0	0
CHMET	Cooling and Heating Capacity Meter	0	0	0	0
DML	Demand Limit	0	0	0	0
VARIOUS					
PTCO	Set up for shipping via container	0	0	0	0

√ Standard component

0 Optional component

◊ Accessory supplied separately (optional)

- Not available

The temperature of the unit is controlled as standard with the temperature probe installed in the return section of the unit.

In the case of configuration with options such as FCE "Enthalpy Free-cooling", HSE "Immersed electrodes steam humidification", PUE "External Humidifier management with 0-10V signal" and CPHG "Hot gas post-heating coil", additional humidity probes are installed in the unit.

Thermoregulation can also be carried out with the controller supplied as standard or the remote probes available as optional components.

- FC Thermal FREE-COOLING**
Standard option for the configurations CBK-G and CCK-REVO.
It reduces energy consumption and wear of the compressor by using outdoor air as an energy source to reduce thermal loads in the indoor environment.
The thermoregulation compares the temperature of the outdoor environment and the indoor environment by defining the amount of fresh air required to guarantee the temperature set-point while keeping the compressors off or at reduced load.
-
- CREFB ECOBREEZE type outdoor section fans consumption reduction device**
Option indicated to reduce the ventilation electric energy consumption considerably and limit sound emissions inside the external section of the unit. ECOBREEZE logic allows the external axial fans to operate at a variable rotation speed, according to the operating conditions of the cooling circuit. Reducing the speed at which the thermal load decreases ensures clear benefits in terms of noise emissions especially at night when people can be most sensitive to noise.
During summer operation, fans can further increase their speed, to respond to situations in which operation limits are temporarily exceeded. ECOBREEZE option uses special fans powered by brushless electrical motors, with complete electronic control, and distinguished by a very high efficiency.
To ensure continuous cooling operation even at temperatures below 15°C, the option is necessary to maintain correct condensation on the external heat exchanger.
- 
- CTEM Ambient temperature control with probes on board the unit**
Thermoregulation is carried out on the conditions of the return airflow.
-
- SER Manual outdoor air damper**
Standard option for the configuration CBK.
The damper on the outdoor section does not change position depending on the operating state and it is opened at the manually predefined both when the unit is switched on and when the unit is switched off.
-
- SERMD Modulating motorised outdoor air damper**
The modulating motorised outdoor air damper is standard for CBK-G and CCK-REVO configurations and available as an option for CBK configuration.
When the external conditions are favourable, the FREE-COOLING mode is activated and the external air damper is modulated to meet the internal set-point.
-
- CMSC9 Serial communication module for Modbus supervisor**
Allows serial connection to supervision systems, using Modbus as a communication protocol. It allows the access to the entire list of operation variables, controls and alarms. With this accessory, every unit can communicate with the main supervision systems. The device is installed and wired on the unit.
- ⚠ The total length of each individual serial line must not exceed 1000 m and the line must be connected in bus type (input/output).
-
- PM Phase monitor**
The phase monitor allows verifying the proper phase connection and their unbalance in the units powered by the three-phase system. The monitor communicates with the control circuit and orders the switch-off of the unit should one of the following cases occur: improper phase connection; the limit value referring to the unbalance between the phases is exceeded; over/under-voltage for a certain amount of time. As soon as the nominal line conditions are restored, the unit is automatically reset. The device is installed and wired on the unit.

VENH

High static pressure fans

A higher capacity fan section is available for applications requiring high supply and return head. The option is comprised of radial fans coupled directly to electronically controlled motors (brushless). When you select a unit on the www.clivet.com website, choose the air flow, the available supply and return pressure, and the accessories that determine the head loss on the air side, you will be automatically shown a selection of high head fans, when required. This option involves variation of the main electrical data of the unit.



F7 F9

High efficiency F7 air filter (ISO 16890 ePM1 55%)

High efficiency F9 air filter (ISO 16890 ePM1 80%)

Class F7/F9 filters are additional filtration components along with the standard G4 filters for more efficient filtration. They are widely used in civil air conditioning systems and in industrial applications requesting an adequate yield with respect to fine dust and particles larger than 1 µm. Class F7/F9 filters are made of folded fibreglass paper with constant calibrated spacing, mounted on a metal frame; the large filtering surface is designed to keep air side pressure drops low. Class F7/F9 filters must be replaced after reaching clogging limits with scheduled periodic maintenance. It is possible to provide, as an option, the differential pressure switch for dirty filters to inform the user that the permissible clogging limit has been reached to avoid an excessive reduction in the airflow rate compared to the rated value.



⚠ This option reduces the available static pressure (supply air side).

FIFD

Electronic filters with iFD technology (ISO 16890 ePM1 90%)

High efficiency filters with active electrostatic system with an intense dielectric field are additional filtration components to standard G4 filters (ISO 16890 Coarse 60%). They are effective on a wide range of pollutants, including pollen, dust, microdust and nanodust, toners, moulds, smog, bacteria and viruses with a typical efficiency up to 99.99%. The air filtration process follows the most advanced air purification technologies and consists of these phases:

- First pre-filtration phase
- Second ionisation phase, in which the particles are charged by passing through a thin perforated metal plate with needle electrodes in the centre of each hole.
- Third absorption phase, in which the charged dust particles are captured by a strong and intense dielectric field formed by a honeycomb tube.

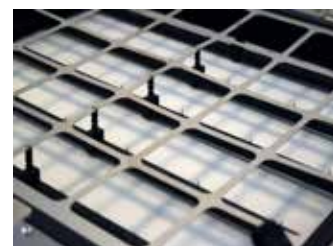

The iFD electronic filters have a very high filtration efficiency with low pressure drops and therefore reduced ventilation consumption compared to traditional filters. The typical air crossing speeds reached in Clivet units ensure filtration efficiencies higher than ISO 16890 ePM1 90% (equivalent to class E10 of absolute filters in accordance with EN 1822).

For this result to be guaranteed and the microbicidal action against bacteria and viruses to be kept steady over time while ensuring minimum load drops, the filters require proper maintenance. This is extremely simple and is done by washing them with a standard kitchen degreaser. This means that the filter cell does not need replacing, just washing.

Filters must be cleaned at least every six months; we recommend quarterly or more frequent cleaning if the units are located in excessively polluted areas. Intervention on the filters during the unit's routine maintenance includes washing the electronic cells on site.

The higher initial cost, compared to a traditional mechanical filter, can be amortized in a short time. Indeed, the lifespan of the electrostatic filters is the same as that of the unit, whereas pocket filters need periodic replacement.

- ⚠ This option reduces the available static pressure (supply air side).
- ⚠ iFD electronic filters are not suitable for filtering water vapours even in low concentrations, oily vapours, large quantities of dust, shavings and iron filing dust, residues in general and gases.
- ⚠ All the following substances must be absolutely avoided with electronic filters: metallic material dust, even if very fine; fumes produced by the combustion of organic and non-organic materials; flour dust; dust and vapours from potentially explosive atmospheres.

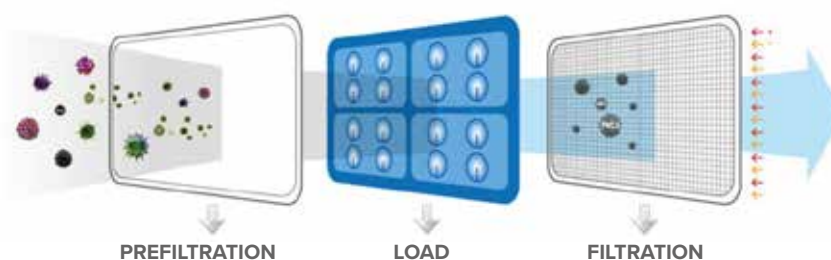

PSAF Clogged filter differential pressure switch air side

It detects and signals when the maximum level of clogging of the air filters has been reached. This alerts the machine operator when maintenance of the filters is required. The detection device is installed in the unit and already connected to the electrical panel of the machine and pre-calibrated in the factory. The calibration can be modified by authorised personnel.



SERM ON/OFF motorised outdoor air damper

Option available for CBK configuration. The position of the external air damper is closed when the unit is switched off to avoid leakage, and during the start-up phase to reach the set-point more quickly. When the unit is switched on and running, it opens and allows the passage of the set flow of outdoor air.

NSERG Gravity exhaust air damper not required

Option that allows configuration of the unit in CBK-G version without gravity exhaust air damper. It is suitable for applications that require the expulsion of air directly into the building. This solution is compatible with the return section in position R0 (Horizontal).

PCOSM Constant supply airflow

The technology used avoids the need for on-site calibration of traditional fans, as well as time and costs associated to do it. The required flow rate is set on the display and maintained automatically by the unit, which controls the speed of the ventilating sections. During the installation and start-up phase, the unit controls to the effective pressure drop in the air distribution and diffusion system. Furthermore, during its entire operating life, the progressive fouling of the air filters is automatically compensated.



PVAR Variable airflow

Option that enables the automatic variation of the treated air flow, according to the effective load. This allows great energy saving, thanks to the reduction of ventilation electrical consumptions. The minimum flow value equal to 60% of the nominal one occurs during the partial load and satisfied set-point operation. As a result, the supply temperature remains unchanged either during full load operation or partial load operation. The device also includes the functions to configure the nominal flow directly on the unit display, and its automatic control to compensate the dirtying of the air filters.



- ⚠ This option already includes the device for controlling the airflow, called 'PCOSM - Supply constant airflow', which must not be selected
- ⚠ When sizing the distribution and diffusion of the air, keep into consideration that the airflow varies from the nominal value (at full load, in FREE-COOLING mode and during the defrosting phases) to the minimum value, equal to 60% of the nominal flow (at partial load)

PVARDP Variable airflow with pressure probe on the unit

This option is recommended in applications for multi zone where is required the variability of the air flow, in according on the actual conditions of use in some rooms. Suitable for aerulic system equipped with VAV/CAV dampers. In case of variation of the aerulic load profile of the system, it allows to automatically change the air flow rate to maintain the set external static pressure.

- ⚠ For effective control, the set external static pressure must be higher than 100 Pa
- ⚠ Supply air flow rate must result inside the admitted air flow range specific for each size

PAQC Air quality probe for the CO₂ rate check

This option is recommended for areas with highly variable crowding. The probe measure the amount of CO₂ in the environment and initiates a proportional signal. Based on the received signal, the controller regulates amount of outdoor air necessary for IAQ ventilation and thus minimises energy used for treatment. The probe is installed and wired built-in the unit and is located in the return air duct of the unit.



- ⚠ This solution can only be provided in combination with "SERMD Modulating motorized outdoor air damper".

PAQCV

Air quality probe for the CO₂ and VOC rate check

The option is recommended in areas with tobacco smoke, formaldehyde (from solvents, deodorants, glues, paints, detergents, food preparation, etc. The probe measures the rate of CO₂ and VOC (volatile organic compounds) in the environment and initiates a proportional signal. Based on the received signal, the controller regulates amount of outdoor air necessary for IAQ ventilation and thus minimises energy used for treatment.

The probe is installed and wired built-in the unit and is located in the return air duct of the unit.

⚠ This solution can only be provided in combination with "SERMD Modulating motorized outdoor air damper".

PPAQC

External CO₂ signal management

The unit is configured with a 0-10V input available for the proportional control of the amount of fresh air according to a signal from a CO₂ detection system to be taken care of by the customer.

⚠ This solution can only be provided in combination with "SERMD Modulating motorized outdoor air damper".

CSOND

Temperature and humidity ambient control with built-in probes

This option makes it possible to measure the temperature and humidity of the ambient directly on the airflow entering the unit. The automatic thermal regulation is done using the on-board probes, whereas the probes on the remote control are inhibited.

CTT

Temperature control with thermostat

Option to directly detect the temperature of the serviced room. The automatic thermoregulation is carried out with the temperature probe in the thermostat to be installed in the room.

⚠ This solution is not compatible with the FCE (enthalpy FREE-COOLING), CPHG (Hot gas post-heating coil) and HSE (Immersed electrode steam humidifier) options and PUE (External Humidifier management with 0-10V signal).

⚠ The thermostat has to be installed in a representative position of the services room conditions.

PGFC

Finned coil protection grilles

Protection grilles on the external exchangers (source side) are provided.

The grilles have a protective and safety functions, in order to prevent vandalism and accidental impacts without altering the heat exchange. It consists of a rigid wire mesh with 25 mm mesh pitch and grey RAL7073 protective coating.

CONTA2

Energy meter

Allows to display and record the unit's main electrical parameters.

The data can be displayed with the user interface on the unit or via the supervisor through the specific Modbus protocol. It is possible to control:

- voltage (V),
- absorbed current (A),
- frequency (Hz),
- phase shifting $\cos \phi$
- power input (kW),
- absorbed energy (kWh),
- harmonic components (%)

⚠ The device is installed and wired on the unit.

⚠ This device is an accurate meter with CE certification; not suitable for legal metrology findings.

CHMET

Cooling and Heating Capacity Meter

System to calculate the heating and cooling capacity by measuring the enthalpy of the supply and return air and the outdoor environment, as well as the indirect measurement of the supply and fresh airflow.

The data can be read directly on the device or through the supervision system with a ModBus communication protocol.

⚠ The device is installed and wired on the unit.

⚠ The capacities detected are to be considered indicative of the operation and the actual work point of the unit and are not comparable to the accuracy of the precise laboratory performance data declared in the Technical Bulletin.

CPHG

Hot gas re-heating coil

This option is recommended during the summer when the intake air dehumidification is required.

The air flow to enter the room may contain a higher level of humidity than desired. The dehumidification process is used to reduce it. The air flow is first cooled in the handling coil with separation of condensation. It is then freely re-heated to maintain the desired condition of comfort in the served room.

The re-heat coil is located after the handling coil and is activated by diverting a flow of hot refrigerant gas downstream from the compressors through the action of a dedicated solenoid valve.

The process starts operating based on the humidity set-point established by the user.

With respect to traditional devices, such as electrical electric elements or hot water coils, use of the re-heat coil does not consume any extra energy. It also lowers refrigerant condensation temperature, which provides two positive effects: power absorbed by the compressors is considerably reduced, and at the same time, cooling capacity is increased, resulting in greater efficiency (EER). Ambient humidity is measured by means of a return humidity probe, which is provided already assembled and wired built-in the unit.

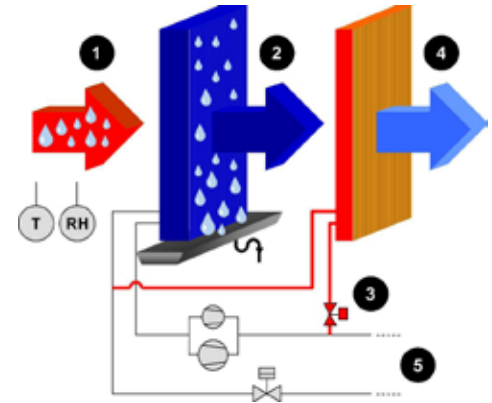

1. Outdoor air and humidity / temperature probe
2. Chilled and dehumidified air in the internal exchanger (evaporator)
3. Automatic hot gas pump valve
4. Air treated by the post-heating exchanger
5. External exchanger (condenser)

Indicative scheme - not in scale

⚠ This option reduces the available static pressure (supply air side).

SIZE		OUTDOOR AIR TEMPERATURE [°C]															
		25	27	30	32	35	25	27	30	32	35	25	27	30	32	35	
		kWt	kWt	kWt	kWt	kWt	kWt	kWt	kWt	kWt	kWt	kWt	kWt	kWt	kWt		
20.2	Qo [m³/h]	9500					13000					14000					
	Qo [l/s]	2639					3611					3889					
	Ta [°C]	10	15,7	17,0	18,8	20,1	22,0	17,6	19,0	21,1	22,5	24,6	18,1	19,5	21,6	23,1	25,2
		12	14,5	15,7	17,6	18,8	20,7	16,2	17,6	19,7	21,1	23,2	16,6	18,1	20,2	21,6	23,8
		14	13,3	14,5	16,3	17,6	19,5	14,8	16,2	18,3	19,7	21,8	15,2	16,6	18,8	20,2	22,4
		16	12,1	13,3	15,1	16,3	18,2	13,5	14,8	16,9	18,3	20,4	13,8	15,2	17,4	18,8	20,9
		18	10,8	12,1	13,9	15,1	17,0	12,1	13,5	15,5	16,9	19,0	12,4	13,8	15,9	17,4	19,5
	20	9,6	10,8	12,7	13,9	15,7	10,8	12,1	14,2	15,5	17,6	11,0	12,4	14,5	15,9	18,1	
	28.2	Qo [m³/h]	13000					17000					20500				
		Qo [l/s]	3611					4722					5694				
Ta [°C]		10	21,7	23,4	25,9	27,6	30,2	23,9	25,7	28,5	30,4	33,2	25,5	27,5	30,4	32,4	35,5
		12	20,0	21,7	24,2	25,9	28,5	22,0	23,9	26,7	28,5	31,4	23,5	25,5	28,5	30,4	33,5
		14	18,3	20,0	22,5	24,2	26,8	20,2	22,0	24,8	26,7	29,5	21,5	23,5	26,5	28,5	31,5
		16	16,7	18,4	20,8	22,5	25,1	18,4	20,2	23,0	24,8	27,6	19,6	21,5	24,5	26,5	29,5
		18	15,0	16,7	19,2	20,9	23,4	16,5	18,4	21,1	23,0	25,8	17,6	19,6	22,5	24,6	27,5
20		13,4	15,0	17,5	19,2	21,7	14,7	16,5	19,3	21,1	23,9	15,7	17,6	20,6	22,5	25,5	
40.4		Qo [m³/h]	17000					23000					26000				
		Qo [l/s]	4722					6389					7222				
	Ta [°C]	10	36,4	38,8	42,7	45,3	49,2	43,3	46,2	50,8	53,9	58,6	46,4	49,4	54,4	57,7	62,7
		12	33,9	36,2	40,1	42,7	46,7	40,4	43,1	47,7	50,8	55,6	43,2	46,1	51,1	54,4	59,5
		14	31,1	33,7	37,5	40,2	44,1	37,0	40,1	44,6	47,9	52,5	39,6	42,9	47,8	51,2	56,2
		16	28,7	31,1	35,0	37,6	41,5	34,2	37,0	41,7	44,8	49,4	36,6	39,6	44,6	47,9	52,9
		18	26,1	28,5	32,4	35,0	38,9	31,1	33,9	38,6	41,7	46,3	33,2	36,3	41,3	44,6	49,6
	20	23,5	25,9	29,8	32,4	36,4	28,0	30,8	35,5	38,6	43,3	29,9	33,0	38,0	41,3	46,4	
	56.4	Qo [m³/h]	22000					32000					34000				
		Qo [l/s]	6111					8889					9444				
Ta [°C]		10	46,9	49,9	54,8	58,1	63,0	57,9	61,6	67,7	71,7	77,8	59,5	63,3	69,5	73,7	79,9
		12	43,6	46,7	51,6	54,9	59,8	53,8	57,7	63,7	67,8	73,8	55,3	59,3	65,5	69,7	75,9
		14	40,4	43,4	48,4	51,7	56,6	49,9	53,6	59,8	63,8	69,9	51,3	55,1	61,4	65,6	71,8
		16	37,2	40,3	45,2	48,4	53,4	45,9	49,8	55,8	59,8	65,9	47,2	51,1	57,4	61,4	67,8
		18	33,9	37,0	41,9	45,2	50,1	41,9	45,7	51,7	55,8	61,9	43,0	47,0	53,2	57,4	63,6
20		30,7	33,8	38,7	42,0	46,2	37,9	41,7	47,8	51,9	57,0	39,0	42,9	49,1	53,3	58,6	

Ta = Leaving air temperature from the handling coil and entering the post-heating coil

Qo = airflow (l/s and m3/h)

kWt = Heating capacity (kW)

The reheating coil is powered by the hot gas bled from the condensing coil.

As the condensation hot gas temperature is linked to the outdoor air temperature, the indicative potentials of the post-heating coil are expressed according to the outdoor air temperature

EXFLOWC

Application in spaces with forced air exhaust at variable flow and exhaust section

Option indicated for CCK-REVO configuration, for conditioning buildings with hoods or active air exhaust systems, for example catering kitchens, labs with suction hoods, where the fresh airflow is variable in function of the number of active extractors. The option involves an electronic device installed built-in the unit that receives the activation status of the extractors on appropriate potential-free, through a single 4-20 mA signal or from a BMS signal. The amount of fresh air is modulated according to these inputs.

The unit is equipped with an exhaust fan section to allow air renewal even with the hoods off. The exhaust section is equipped with a plug-fan fan electronically controlled and managed by the unit logic according to the active suction hoods and the fresh air damper opening. To dimension the unit consider as max. exhaust airflow of the hoods the 50% of the nominal airflow. The air quality probe for controlling the rate of CO₂ / CO₂ and VOC, and the EXFLOWC can be simultaneously selected.

Where necessary, the unit will be integrated with further pre-heating options of which "Electrical heating resistance", "two-rows hot water coil" or "Gas heating module" to guarantee the operation of the unit with 50% of the fresh air in every operating situation, even at low outdoor air temperature.

- ⚠ The electronic device is installed and wired built-in the unit.
- ⚠ The option allows to manage up to 4 ON-OFF contacts from the exhaust devices or one 4-20 mA or via BMS signal (by Customer).
- ⚠ The connection cables for the 4-20 mA signal or the ON-OFF status do not require shielding.
- ⚠ The EXFLOWC option is not compatible with the options 'PVARD Variable airflow with pressure probe on the unit', 'PVMV 4-20mA signal for the supply and exhaust airflow modulation' and 'PPAQC External CO2 signal management'.
- ⚠ With minimum fresh air temperatures between 0°C and -8°C foresees the option "Electrical heating resistance" or "two-rows hot water coil" whereas for minimum temperatures between -8°C e -30°C foresees the "two-rows hot water coil" or "Gas heating module" option.

EH

Electric elements

This option is suggested for cold climates, allows the integration of heating capacity from the heat pump. The electrical heaters are placed before the treatment coil and perform the air preheating function, extending the operating range of the unit and helping quickly to reach the comfort in the room.

Ideal for climate areas in applications with low outside temperature where it is required to active the heaters only for short time in the year. In these cases the resulting system simplification (no water supply) compensates the energy costs.

The fins are made of aluminum, of suitable dimension to ensure high efficiency and maintain low power density on the surfaces to limit overheating. The low temperature of the heating elements increases the lifespan and limits the effect of air ionization.

Matching of the electric elements

SIZE	20.2	28.2	40.4	56.4
9 kW	√	-	-	-
12 kW	√	√	-	-
18 kW	√	√	√	-
24 kW	-	√	√	√
36 kW	-	-	√	√
48 kW	-	-	-	√

- ⚠ This operation involves variation of the main electrical data of the unit.
- ⚠ "Heating elements", "Condensig gas heating module with modulating control", "Energy recovery from food refrigeration" and "Two rows hot water coil" cannot be fitted at the same time.

Operation field extension with electric heaters DT (°C)

SIZE	Airflow rate [m ³ /h]	9 kW	12 kW	18 kW	24 kW	36 kW	48 kW
20.2	13000	2,1	2,7	4,1	-	-	-
28.2	17000	-	2,1	3,1	4,2	-	-
40.4	23000	-	-	2,3	3,1	4,6	-
56.4	32000	-	-	-	2,2	3,3	4,4

The minimum operating temperature of the heat pump with electric heater change and depends on the series and the power of the electric heater. The minimum temperature is easily to reckon subtracting the DT value (previous table) to the entering internal exchanger air temperature TM(D.B.) for standard unit, at the desired conditions.

CHW2

Two-rows hot water coil

Option indicated for very cold climates, as it allows to heat up the area served. The exchanger comes with a thermostat for the antifreeze function, which is always active even when the unit is in stand-by, as long as it is operated electrically. If required, force the opening of the valve to the maximum value allowed to allow the air to pass through the exchanger and prevent frost from forming.

The hot water coil allows the integration of the heat pump capacity, as being placed before the treating coil, it pre-heats the air, extending the operation limits of the unit. If the water coil operates as integration to the heat pump, the control logic reduces the potential at a pre-determined limit value, which prevents to make the compressors work at too high condensation temperatures. On the other hand, if the water coil is used as main resource (i.e. availability of the compressors) the potential supplied will be the highest.

In the event laws or local standards encourage the use of the district heating, and so the use of hot water coil heating with the obligation to recover the energy contained inside the exhaust air flow, a turning point can be set, that is an outside air temperature, below which the unit uses the water coil as main resource and operates also as thermodynamic recuperator at very high efficiency, using the nominal capacity of the heat pump circuit only partially.

With the option is available a potential-free contact for the water circulator start-up (provided by the Installer).

Hot water coil pressure drops: AIR side

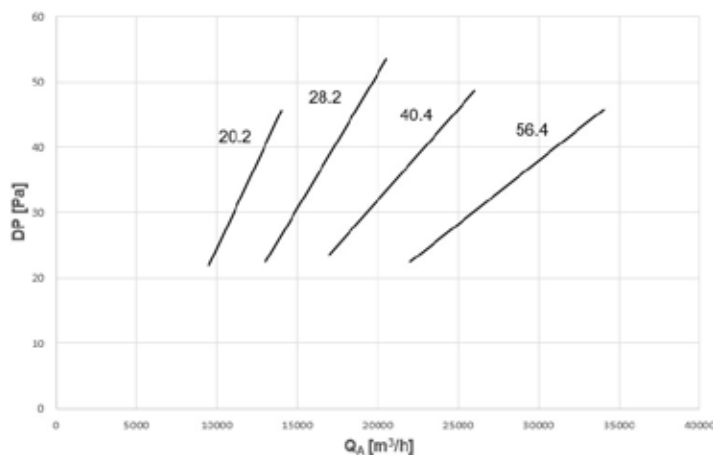

The air side pressure drops are relative to the medium air temperature of 20°C and are to be added to the pressure drops due to ducts, terminal devices and any other component that causes a drop in working discharge head.

QA [m³/h] = Airflow

DP [Pa] = Pressure drops

Hot water coil pressure drops: WATER side

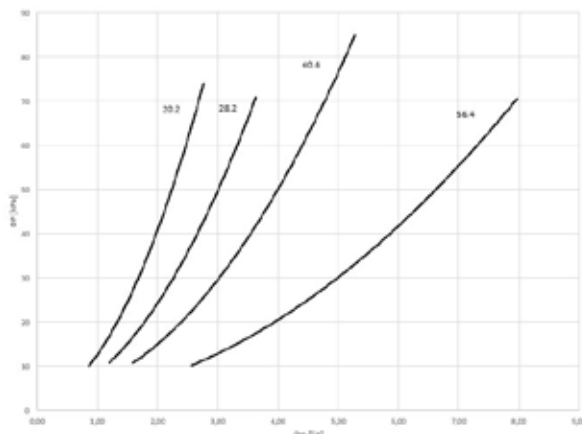

Pressure drops on the water side are calculated considering an average water temperature of 65°C

Qw [l/s] = Water flow-rate

DP = Pressure drops [kPa]

$$Qw [l/s] = P / (4.186 \times DT)$$

P = Water coil heating capacity in KW

DT = Temperature difference between inlet / outlet water

This option reduces the available static pressure (supply air side).

- ⚠ The component requires connection to the hot water plumbing system (to be provided for by the client).
- ⚠ "2 range hot water coil", "Electric elements", "Condensing gas heating module with modulating control" and "energy recovery from food refrigeration" cannot be assembled simultaneously

Accessories

CHW2 Performance of hot water coil (2 ranges)

		Ti/To [°C]												
		60/40	70/55	70/60	80/65	60/40	70/55	70/60	80/65	60/40	70/55	70/60	80/65	
		kWt	kWt	kWt	kWt	kWt	kWt	kWt	kWt	kWt	kWt	kWt	kWt	
20.2	Qo [m³/h]	9500				13000				14000				
	Qo [l/s]	2639				3611				3889				
	TM [°C]	5	80,3	106,0	111,7	125,3	98,3	130,4	137,7	154,4	103,1	136,7	144,5	161,9
		10	70,4	96,0	101,7	115,2	86,1	118,1	125,4	141,9	90,1	123,8	131,6	148,8
		14	62,5	88,1	93,7	107,2	76,4	108,3	115,6	132,1	80,0	113,6	121,4	138,6
		16	58,6	84,1	89,8	103,3	71,5	103,5	110,8	127,2	74,9	108,5	116,3	133,4
		18	54,6	80,2	85,9	99,3	66,7	98,7	105,9	122,3	69,8	103,5	111,2	128,3
		20	50,7	76,3	81,9	95,4	61,8	93,9	101,1	117,5	64,7	98,4	106,1	123,3
	Qo [m³/h]	13000				17000				20500				
	Qo [l/s]	3611				4722				5694				
28.2	TM [°C]	5	108,9	143,7	151,5	169,8	129,4	171,5	181,1	203,1	145,6	193,3	204,4	229,0
		10	95,5	130,2	137,9	156,2	113,5	155,4	164,9	186,6	127,4	175,1	186,2	210,5
		14	84,8	119,5	127,1	145,4	100,7	142,6	152,1	173,7	112,9	160,7	171,7	195,9
		16	79,5	114,0	121,8	140,0	94,3	136,2	145,7	167,3	105,8	153,5	164,5	188,7
		18	74,1	108,8	116,5	134,7	87,9	129,9	139,4	160,9	98,6	146,3	157,3	181,5
		20	68,7	103,5	111,2	129,3	81,5	123,5	133,0	154,6	91,4	139,2	150,2	174,3
Qo [m³/h]	17000				23000				26000					
Qo [l/s]	4722				6389				7222					
40.4	TM [°C]	5	144,0	186,3	194,7	219,2	174,8	226,9	237,7	267,2	188,6	245,2	257,0	288,8
		10	127,5	170,1	178,7	203,1	154,7	207,1	218,0	247,5	166,8	223,8	235,6	267,4
		14	114,3	157,2	165,8	190,2	138,4	191,3	202,2	231,7	149,3	206,6	218,6	250,3
		16	107,6	150,7	159,4	183,8	130,3	183,4	194,3	223,8	140,4	198,0	210,0	241,8
		18	100,9	144,3	153,0	177,4	122,1	175,4	186,4	215,9	131,6	189,4	201,5	233,2
		20	94,1	137,8	146,5	170,9	113,8	167,5	178,6	208,0	122,6	180,8	193,0	224,7
Qo [m³/h]	22000				32000				34000					
Qo [l/s]	6111				8889				9444					
56.4	TM [°C]	5	188,2	243,9	255,12	287,1	239,3	311,5	326,6	367,0	248,4	323,7	339,5	381,4
		10	166,6	222,7	234,04	266,0	211,6	284,3	299,5	339,8	219,6	295,3	311,3	353,1
		14	149,2	205,8	217,19	249,1	189,2	262,4	277,8	318,1	196,4	272,6	288,7	330,5
		16	140,4	197,3	208,77	240,7	178,0	251,5	266,9	307,3	184,7	261,2	277,4	319,2
		18	131,6	188,8	200,35	232,2	166,7	240,6	256,1	296,4	173,0	249,9	266,1	307,9
		20	122,7	180,3	191,93	223,8	155,3	229,6	245,2	285,5	161,2	238,5	254,8	296,6

TM = air inlet temperature of water coil (°C)

Ti/To = water inlet/outlet temperature (°C)

Qo = airflow (l/s and m³/h)

kWt = Provided heating capacity (kW)

Thermal yields referred to the max. water coil capacity. The thermo regulator chokes the 3-way modulating valve limiting the inlet air temperature at desired values.

FCE Enthalpy FREE-COOLING

This option is used to reduce energy consumption and compressor wear by using the outdoor air as an energy source to lower the thermal loads and ambient humidity. The temperature control compares the temperature and the humidity between the outdoor environment and the served environment and decides the amount of fresh air needed to guarantee the correct temperature and humidity set-points in the environment, keeping the compressors off or at a reduced load.

The air humidity, both outside and inside the environment, is measured by means of humidity probes on the outdoor and return air intake, which are provided already installed and wired on the unit.

2WVM
3WVM

Modulating 2-way valve
Modulating 3-way valve

To be combined with hot water coil (optional). It is managed by the built-in microprocessor via a 0-10V signal and allows the fully automatic control of the water coil. The valve with modulating actuator is provided already assembled and wired built-in the unit.

Valve pressure drops

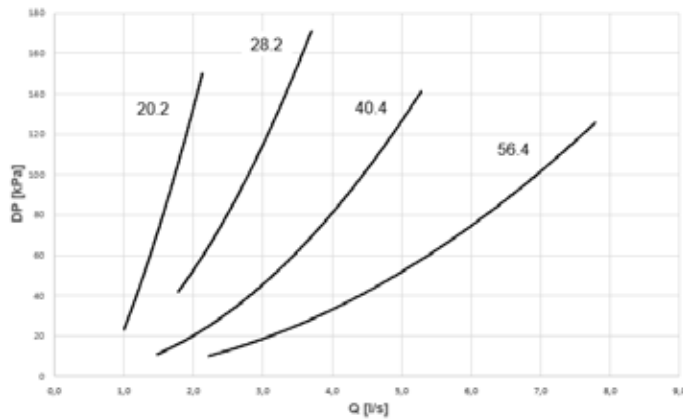

Q [l/s] = water flow-rate
DP [kPa] = pressure drops

⚠ This accessory has to be coupled to the "CHW2 - Two-row hot water coil" option

3WVM

Modulating 3-way valve for energy recovery from food refrigeration

To be combined with water coil for the energy recovery from food refrigeration. It is managed by the built-in microprocessor via a 0-10V signal and allows the fully automatic control of the water coil. The valve with modulating actuator is provided already assembled and wired built-in the unit.

Valve pressure drops

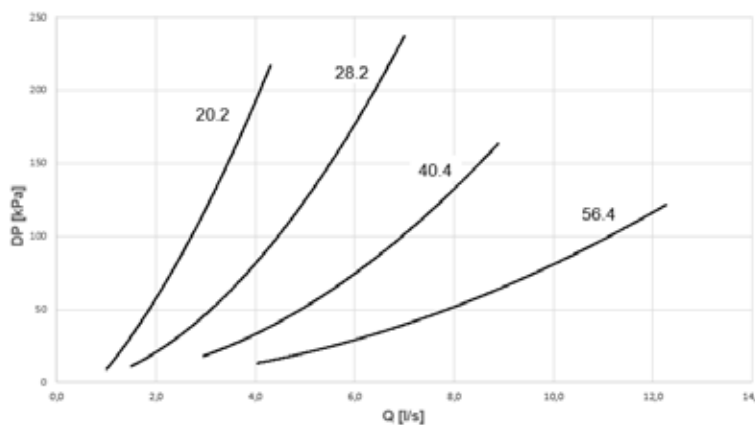

Q [l/s] = water flow-rate
DP [kPa] = pressure drops

⚠ This accessory has to be coupled to the "CHWER - Energy recovery from food refrigeration" option.

PVMV

4-20mA signal for the supply airflow modulation

Through this option, the supply airflow can be adjusted through a single external 4-20mA signal.

A suitable solution in systems serving several rooms having similar heat load profiles, but it is separated from each other and occupied in a discontinuous way.

In periods of sanitary emergency, it is suitable for managing a lower airflow than the nominal one, as well as keeping the system on at night, thereby ensuring that internal pollutants are continuously diluted.

The airflow can linearly vary according to the signal received; these values must be within the range of the airflow rates allowed for the selected model.

⚠ PVMV is not compliant with 'PCOSM - Constant supply airflow', 'PVAR - Variable airflow' and 'PVARDP - Variable airflow with pressure probe on the unit'

HSE Immersed electrodes steam humidifier

This device is suitable for winter operation when humidity is required for the ambient without cooling the air flow. The automatic modulating control allows you to adjust the steam production and its relative management costs to the actual requirements.

Available in different capacities, the device is suitable for using soften water having medium conductivity and is equipped with: water load solenoid valve, disposable cylinder, water drainage solenoid valve, distribution nozzle, control electronic board to verify the water level, conductivity, anti-foam device, water drainage manual forcing. To ensure maximum hygiene, the cylinder can automatically empty after a determined period of stand-by.

The accessory is installed inside the unit and is connected to the electrical panel of the unit.

Ambient humidity is measured by means of a return humidity probe, which is provided already assembled and wired built-in the unit.

With the option is available a potential-free contact for the water emptying during the period in which the unit is not used (connection provided by the Customer).



Matching of immersed electrode and steam humidification module

SIZE	20.2	28.2	40.4	56.4
3 kg/h	√	√	-	-
5 kg/h	√	√	-	-
8 kg/h	√	√	√	√
15 kg/h	√	√	√	√

⚠ This operation involves variation of the main electrical data of the unit.

⚠ This accessory requires connection to a water supply network and discharge water circuit. Installation provided by the Customer.

⚠ Operation is available in heating mode

PUE External Humidifier management with 0-10V signal

Solution suitable for applications where there is a humidification section external supplied by a third party. The external humidifier is operated with the 0-10V signal coming from the unit.

PCMO Sandwich panels of the handling zone in M0 fire reaction class

Option indicated when, by law, the air treatment area must have metallic internal walls made with fire-proof insulating material. Sandwich panels with dual walls made of steel sheet metal with fire-proof insulation made of Rockwool (90 kg/m³) comply with the French standards, which require “M0” reaction to fire class.

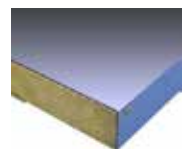

LTEMP1 Application for low outdoor temperature

Option indicated for very cold climates, where the outside temperature can be between -10°C and -25°C.

- The option includes self-regulating heaters with thermostats that can protect the electrical panel from freezing to make sure it operates correctly.
- The outdoor air damper is made of anti-seize devices that ease the correct control of the fresh air in every climatic situation, thanks to the teflon supporting bushings, aluminium flaps, PVC end gaskets and steel leverages to compensate expansion
- The motorised actuator is suitable for operating with low outdoor temperatures.
- Electrical connection cables suitable for outdoor low temperatures

⚠ This operation involves variation of the main electrical data of the unit.

⚠ This accessory operates even when the unit is switched off provided that the power supply is maintained active and the unit continues to be connected.

⚠ It is necessary to make precautions against build up of snow and ice in front of the exhaust and outdoor air inlet locations.



CHWER Energy recovery from food refrigeration

This option makes it possible, during the winter season, to recover the heating energy produced by food storage in supermarkets, hypermarkets or food factories. It is a technical solution that recovers a significant heating resource, which is otherwise normally released outdoors.

The unit logic assigns a priority value to this function based on the heating availability of the resource, and integrates the overall output of the unit.

The option is comprised of a water exchanger, which is automatically controlled by a dedicated valve. With electrically powered units, the frost function is enabled, which forces the valve open when required.

Hot water coil pressure drops: AIR side

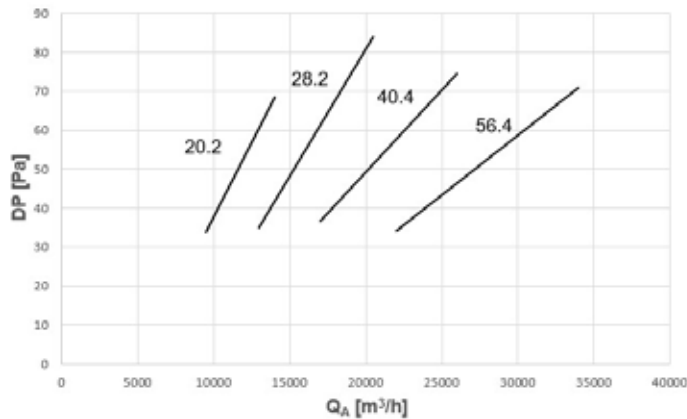

The air side pressure drops are relative to the medium air temperature of 20°C and are to be added to the pressure drops due to ducts, terminal devices and any other component that causes a drop in working discharge head.

QA [m³/h] = Airflow
DP [Pa] = Pressure drops

Hot water coil pressure drops: WATER side

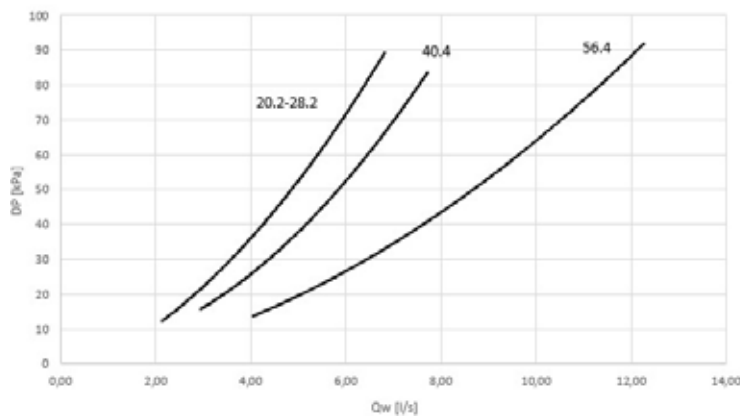

Pressure drops on the water side are calculated considering an average water temperature of 65°C

Qw [l/s] = Water flow-rate
DP [kPa] = Pressure drops

$$Qw [l/s] = P / (4.186 \times DT)$$

P = Water coil heating capacity in KW
DT = Temperature difference between inlet / outlet water

This option reduces the available static pressure (supply air side).

- ⚠ The component requires connection to the hot water plumbing system (to be provided for by the client).
- ⚠ "Electric elements" "Condensing gas heating module with modulating control" and "Energy recovery from food refrigeration" cannot be assembled simultaneously.

Accessories

CHWER Energy recovery from food refrigeration

		Ti/To [°C]									
		45/40	40/35	35/30	45/40	40/35	35/30	45/40	40/35	35/30	
		kWt	kWt	kWt	kWt	kWt	kWt	kWt	kWt	kWt	
20.2	Qo [m³/h]	9500			13000			14000			
	Qo [l/s]	2639			3611			3889			
	TM [°C]	5	88,1	75,9	63,8	110,6	95,3	79,9	116,5	100,3	84,2
		10	75,5	63,5	51,5	94,8	79,7	64,4	99,9	83,9	67,8
		14	65,6	53,7	41,8	82,4	67,3	52,2	86,9	70,9	55,0
		16	60,8	48,9	37,0	76,3	61,2	46,1	80,4	64,5	48,6
		18	55,9	44,1	32,2	70,1	55,2	40,1	73,9	58,1	42,2
		20	51,1	39,3	27,4	64,1	49,1	34,1	67,5	51,8	35,9
	28.2	Qo [m³/h]	13000			17000			20500		
		Qo [l/s]	3611			4722			5694		
TM [°C]		5	117,5	101,5	85,3	142,5	123,0	103,3	162,3	140,0	117,6
		10	100,9	84,9	68,9	122,4	102,9	83,5	139,5	117,2	94,9
		14	87,8	71,9	56,0	106,5	87,1	67,8	121,3	99,2	77,0
		16	81,3	65,5	49,6	98,6	79,3	60,0	112,3	90,2	68,1
		18	74,8	59,1	43,3	90,7	71,5	52,2	103,3	81,3	59,3
		20	68,4	52,7	36,9	82,9	63,8	44,5	94,4	72,5	50,5
40.4		Qo [m³/h]	17000			23000			26000		
		Qo [l/s]	4722			6389			7222		
	TM [°C]	5	148,6	128,7	108,8	184,4	159,7	134,9	200,7	173,8	146,8
		10	129,0	109,1	89,2	160,0	135,2	110,4	174,1	147,1	120,0
		14	113,3	93,4	73,4	140,5	115,6	90,7	152,8	125,8	98,6
		16	105,5	85,5	65,5	130,7	105,8	80,9	142,2	115,1	87,9
		18	97,6	77,6	57,5	120,9	96,0	71,0	131,5	104,3	77,1
		20	89,8	69,7	49,5	111,1	86,1	61,0	120,8	93,6	66,2
	56.4	Qo [m³/h]	22000			32000			34000		
		Qo [l/s]	6111			8889			9444		
TM [°C]		5	194,0	168,1	142,1	253,6	219,5	185,4	264,4	228,9	193,3
		10	168,4	142,5	116,4	220,0	185,9	151,7	229,4	193,8	158,1
		14	148,0	121,9	95,8	193,1	158,9	124,6	201,3	165,6	129,8
		16	137,7	111,6	85,4	179,6	145,4	111,0	187,3	151,5	115,7
		18	127,5	101,3	75,0	166,2	131,9	97,4	173,2	137,4	101,4
		20	117,2	91,0	64,6	152,7	118,3	83,7	159,1	123,3	87,2

TM = air inlet temperature of water coil (°C)

Ti/To = water inlet/outlet temperature (°C)

Qo = airflow (l/s and m³/h)

kWt = Provided heating capacity (kW)

Thermal yields referred to the max. water coil capacity. The thermo regulator chokes the 3-way modulating valve limiting the inlet air temperature at desired values.

PTCO

Set up for shipping via container

Option that allows shipping via container.

It includes the sheet steel slide application for an easy unit scrolling, packaging with protective angle brackets and nylons, anchoring systems. If necessary the lateral lifting brackets and the main isolator switch handle can be removed to avoid damages during transport (components removed and put inside the unit).

For particular requirements, please contact Clivet Shipping Department.

DML

Demand Limit

The partial or total activation of the compressors - and the heating electric resistance where present - can be disabled to limit the overall electric capacity absorbed. This function is manageable via BMS, through parameter or 0-10V external signal. Higher the signal and lower is the capacity the unit can deliver activating compressors, electrical resistances and auxiliary heating systems. Demand Limit function does not affect the control, the ventilation or the energy recovery from food refrigeration, which are therefore always guaranteed. Any other auxiliary heating system (if present) is instead switched off.

DESM

Smoke detector

This option allows detection of smoke in the room by analyzing the return air. The Tyndal-effect increased sensitivity smoke detector is perfect for ventilation ducts since it is able to detect rarefied smoke in high-speed air flows. Smoke detection occurs using a photo-optical system with a labyrinth chamber. The alarm signal is processed by a built-in micro-processor which verifies the condition and sends a message to the unit controller such as smoke alarm or failure. The device is installed inside the unit and it is made up of a sensor, installed inside the return piping, and of a controller that is located on the outside duct.



Control logics in the event of alarm signal

COMPLETE UNIT SHUTDOWN

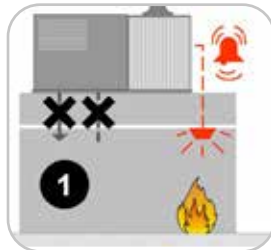

SPACE IN OVERPRESSURE

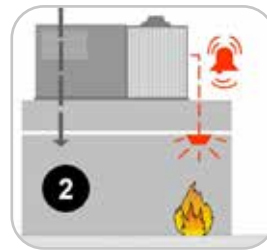

SPACE IN UNDER PRESSURE

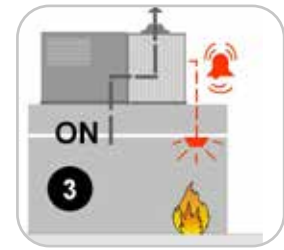

The unit is able to manage the signal coming from a fire detection system activating one of the logics illustrated, which can be set by parameters. In presence of alarm signal, the compressors are always switched off; moreover, the remote ON-OFF is disabled together with the switch on/off control from keypad. The unit is manually reset. Rooftop units cannot be used as fume extractor.

⚠ Any fire detection devices built-in the unit must be considered as an auxiliary safety system, and, accordingly, must not be a replacement for any fire detection devices in the room.

CCCA

Copper / aluminium coil with acrylic lining

Coils with copper pipes and aluminium fins with acrylic lacquering. Can be used in settings with air with low saline concentrations or other moderately aggressive chemical agents. Attention!

- Cooling capacity variation -2.7%.
- Compressor power input variation +4.2%.
- Operating range reduction -2.1°C.

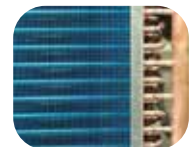

- ⚠ Configurable coating for all the coils of the refrigerant circuit (Handling, Source, Hot gas post-heating - CPHG).
- ⚠ Water coil treatment (CHW2 and CHWER) available on request

CCCA1

Copper/aluminum coil with Fin Guard (Silver) treatment

A treatment which offers an optimal thermal exchange and guarantees and protects the finned coil exchangers from corrosion over time. Can be used in settings with very aggressive saline concentrations and other chemical agents in the air thus maintaining the performance of the coils over time.

- ⚠ Option available on request.



CCCC

Copper / copper coil

Coils with copper pipes, copper fins and brass structure. Can be used in settings with air with low saline concentrations or other chemical agents. The options are available for:

- external coil;
- internal coil;
- hot water coil;
- re-heating coil.

- ⚠ This option is not suitable for application in sulphuric environments.
- ⚠ Option available on request.



Accessories separately supplied

CLMX

Clivet Master System

CLIVET MASTER SYSTEM is the ideal system for the remote and centralised control of the CLIVETPack and SMARTPack climate control units. It can manage up to 10 units connected with a serial connection. It includes a box for wall installation, as well as the electronic power supply and serial communication devices, a controller with a touch-screen display and a USB port at the front used to export the alarm log.

The device allows to easily and intuitively access all the information on the status of the system and the climate control units. It also provides:

- auto-detection of units connected;
- setting all unit parameters;
- setting of the zone set-point;
- unit status display;
- control and management of the alarms and creation of an alarm log;
- hourly operation scheduling (ON / OFF / ECO);
- rotation of the units even for individual areas;
- temperature, humidity and air quality trends;
- automatic language management (English, Italian, French, Spanish and German).

- ⚠ The component must be combined with the RS485 serial port option with Modbus protocol built-in of each rooftop.
- ⚠ Operating temperature from 0°C to 50°C with relative humidity lower than 90% without condensate.
- ⚠ Installation provided by the Customer.



IOTX

IoT industrial module for cloud based interoperability & services

This device allows the monitoring and the remote control the unit via Clivet Eye, the supervision cloud system for Clivet units.

With IoT module (i-LINK) it will be possible to monitor and manage the unit through the mobile app Clivet Eye and the dedicated web page.

Among the main functions, for all monitored units they allow to:

- display the main working parameters;
- display the alarms;
- switch on/off the unit;
- change the setpoint;
- change the operating mode;
- set the daily/weekly start-up or power-off programming of the unit;
- create charts of main system parameters trend (via web interface);
- display in a map the units monitored by Clivet Eye (via web interface).

Web interface at www.cliveteye.com.

Clivet Eye app available in Google Play and Apple Store

- ⚠ IoT module to be provided for each unit to be remotely monitored.
- ⚠ Internet ethernet connection in charge of customer.
- ⚠ Clivet Eye management is alternative to an external BMS supervision system.
- ⚠ Installation provided by the Customer.



AMRX

AMMRX

AMRUVX

AMREW X

Rubber antivibration mounts

Rubber antivibration mounts for unit and gas module

Rubber antivibration mounts for unit and UV-C lamp module

Rubber antivibration mounts for unit and enthalpy wheel module

The rubber antivibration mounts must be fixed to designated housings on the support stringers and are used to dampen vibrations produced by the unit, thereby reducing the noise transmitted to the support structures. They are flexible bodies able to dampen axial and tangential stresses and maintain the mechanical properties almost constant over time thanks to high resistance materials of which they are made.

Alternatively, rubberized neoprene anti-vibration strips may be used on the unit longitudinal support members (not supplied by Clivet).

- ⚠ Installation provided by the Customer.



RCX

Roof curb

Option that allows to connect the unit to the building roof, ideal with downflow supply and return. It is made up of two part, a solid steel frame for the air duct connection and a adjustment support in height. Both parts are made of galvanized steel with a steel rain cover profile painted in the same unit colour. It has an adequate support and a duct connection simplification. It is supplied not assembled and it has to be assembled directly in the construction site, to facilitate the transport and installation.

It is complete with adjusting screws to adapt to any slopes or difference in height of the cover. Once the frame is assembled, it will be necessary to insulate and seal the roof curb to the roof to guarantee the resistance to atmospheric agents, later it will be necessary only to place the unit.

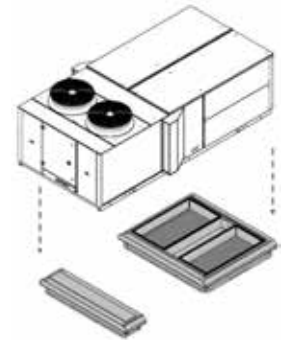

- ⚠ If the gas module is selected, provide for an appropriate support structure, the supply air can only be horizontal.
- ⚠ Installation provided by the Customer.
- ⚠ For size 56.4 height adjustment is not available.

UVCX

UV-C germicidal lamps module

The UV-C lamp module is a well-established technology in HVAC applications and it is realized to be effective on viruses such as SARS-CoV-2 and main bacteria such as Legionella, etc.

UV-C lamps use ultraviolet radiation to purify the air from the development of bacteria, moulds, fungi and viruses. Recent Italian and Japanese studies have demonstrated the effectiveness on Coronavirus SARS CoV2 (known as Covid-19) by defining the dose of UV-C rays required to deactivate it.

The bactericidal and virucidal action is achieved with low pressure mercury lamps through the direct radiation of the air flow with a wavelength of 254 nm.

In rooftop systems, UV-C lamps are installed downstream of the handling coil and act directly in the air flow.

The option is installed in a separate module, outside the unit, with a dedicated electrical panel and separate power supply. It is activated by the unit's logic when the supply fans are running.

The radiation is completely contained and shielded inside the unit to avoid accidental contact with people; in fact, exposure to the rays without the necessary safety devices can cause skin burns and damage vision.

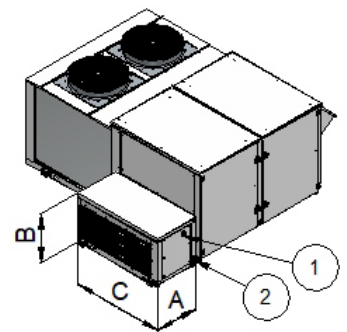

1. Isolator switch
2. Power input

SIZES		20.2	28.2	40.4	56.4
A	mm	780	780	1080	1080
B	mm	773	773	1070	1070
C	mm	1470	1895	1890	2485
F.L.A.	A	1,3	2	2,6	2,6
F.L.I.	kW	0,3	0,5	0,6	0,6

- ⚠ The component requires a 230/1 ~ / 50 power supply to be provided by the customer.
- ⚠ Installation provided by the Customer.

MDMTX

Management of temperature ambient probes

By selecting this option it is possible to provide from 1 to 4 remote room temperature probes. The values recorded by the probes can be consulted on the remote control and with the available supervision systems.

The average of the values recorded by the probes can be used for thermoregulation.

- ⚠ Place the probes in a position that represents the conditions of the environment served.



MDMTUX

Management of temperature and humidity ambient probes

By selecting this option it is possible to provide from 1 to 4 remote room temperature and humidity probes. The values recorded by the probes can be consulted on the remote control and with the available supervision systems.

The average of the values recorded by the probes can be used for thermoregulation.

- ⚠ Place the probes in a position that represents the conditions of the environment served



Accessories separately supplied

GCX

Condensig gas heating module with modulating control

Option consisting of a combustion chamber and condensation burner with modulating control. It is available in various capacities and heats the environment served. The module can be chosen to integrate the heat pump or as an alternative to it. In this case, its heating capacity must be at least equal to the capacity envisioned in the project.

Thanks to the condensation technology with pre-mix and extremely efficient modulation (up to 105% depending on the lower heat value), consumption is very contained and considerably reduced during operation at partial load. The burner with low polluting emissions (NOx lower than 80mg/kWh) in accordance with Class 5 of European standard EN 676.

The option is provided with a separate module that can be easily connected to the unit during installation.

The gas module presence needs the horizontal supply.

The heating module includes:

- hot air generator with condensation and integrated modulating adjustment, powered with methane gas
- kit for transformation of power with liquefied petroleum gas (LPG)
- kit of steel chimney for exhaust fumes
- all the control and safety devices

Gas connection diagram

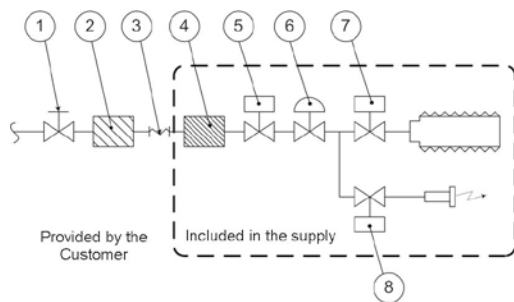

1. Gas shut-off valve
2. Gas filter (large section)
3. Anti-vibration joint
4. Gas filter (small section)
5. Safety gas solenoid valve
6. Pressure stabiliser
7. Main gas burner solenoid valve
8. Pilot burner gas solenoid valve

Matching of the condensig gas heating module

	CAPACITY	20.2	28.2	40.4	56.4
GC01X	35 kW	✓	✓	-	-
GC08X	44 kW	✓	✓	-	-
GC09X	65 kW	✓	✓	✓	-
GC10X	82 kW	-	✓	✓	✓
GC11X	100 kW	-	✓	✓	✓
GC12X	130 kW	-	-	✓	✓
GC13X	160 kW	-	-	-	✓

This option reduces the available static pressure (supply air side).

⚠ The component requires gas supply (gas connections to be made by the Customer). The location of the unit and the fume drain mode must comply with laws and standards in force in the Country of use.

⚠ The assembly of the chimney kit must be performed on site by the Customer. According to specific requirements of installation, the chimney length can be increased by means of appropriate joints and fittings (not supplied by Clivet). For further details, refer to the Installation, use and maintenance manual.

⚠ "2 range hot water coil", "Electric elements", "Condensig gas heating module with modulating control" and "energy recovery from food refrigeration" cannot be assembled simultaneously.

Gas use features

		35kW		44kW		65kW		82kW		100kW		130kW		160kW	
		min	max	min	max	min	max	min	max	min	max	min	max	min	max
Rated heating capacity	kW	7,6	34,8	8,5	41	12,4	65	16,4	82	21	100	12,4	130	16,4	164
Efficiency Hi (P.C.I.)	%	107	96,3	105,9	96,2	108,1	96,8	108,4	97,6	108,4	97,2	108,1	96,8	108,4	97,6
Efficiency Hs (P.C.S.)	%	96,4	86,8	95,4	86,7	97,4	87,2	97,6	87,9	97,8	87,5	97,4	87,2	97,6	87,9
Max condensation produced	l/h	0,9		1,1		2,1		3,3		2,7		4,2		6,6	
Carbon monoxide CO (0% di O ₂)	ppm	<5		<5		<5		<5		<5		<5		<5	
Nitrogen oxides - NOx (0% di O ₂)		42 mg / kWh 24 ppm		33 mg / kWh 19 ppm		39 mg / kWh 22 ppm		32 mg / kWh 18 ppm		41 mg / kWh 23 ppm		40 mg / kWh 23 ppm		34 mg / kWh 19 ppm	
Available flue pressure	Pa	90		90		120		120		120		120		120	
Gas connection diameter	GAS	UNI ISO 228/1 - G 3/4"		UNI ISO 228/1 - G 3/4"		UNI ISO 228/1 - G 3/4"		UNI ISO 228/1 - G 3/4"		UNI ISO 228/1 - G 3/4" M		UNI ISO 228/1 - G 1 1/2"		UNI ISO 228/1 - G 1 1/2"	
Flue pipe diameter	mm	80		80		80		80		80		2 x 80		2 x 80	
Seasonal space heating energy efficiency [EU Reg./2281/2016] [η _s , h]	%	92,1		90,8		93,2		93,2		93,1		93,9		94	
Emission efficiency [EU Reg./2281/2016] [η _s flow]	%	97,3		97		97,4		97,1		97		98,1		97,9	
Power supply pressure (for gas G20)	mbar	20 [min 17 - max 25]													
Gas consumption @15°C - 1013 mbar (for G20 gas)	m ³ /h	0,8	3,69	0,9	4,44	1,31	6,88	1,74	8,68	1,9	10,58	1,31	13,76	1,74	17,36

EWX

Enthalpy wheel energy recovery module

Thanks to the hygroscopic treatment of the exchange surface, the enthalpy wheel allows the efficient transfer of sensitive and latent heat from the exhausted air extracted from the building to the fresh air and vice versa.

Option suitable for applications with high percentages of outdoor air and considerable difference between outdoor and indoor temperature conditions.

The fixed-speed rotary recuperator combines a high exchange surface with overall compactness of the module.

The recovery of latent and sensitive energy is greater under extreme conditions, reducing the capacity required for the refrigeration circuit and any auxiliary systems.

During free-cooling operation the enthalpy wheel is automatically turned off.

The option is provided with a separate module that can be easily connected to the unit during installation.

The enthalpy wheel energy recovery module comprises:

- Enthalpy wheel
- Extraction fans (RAD/EC)
- ISO 16890 Coarse 50% (G4) filters upstream of the rotor for both flows
- Control and safety devices

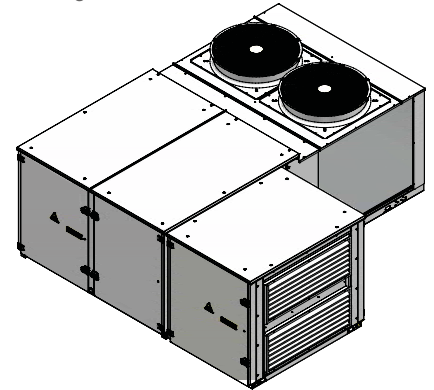

Option compatible with available thermal integration systems

⚠ This option is only compatible with the return section in position R3 (Downward air return) and CBK-G configuration.

⚠ This option involves variation of the main electrical data of the unit.

⚠ This option reduces the available static pressure (supply air side).

Enthalpy wheel combinations

	20.2	28.2	40.4	56.4
EW12X	✓	✓	-	-
EW18X	-	-	✓	✓

			20.2	28.2	40.4	56.4	
Airflow rate*		m ³ /h	3900	5100	6900	9600	
Wheel diameter		mm	1200	1200	1800	1800	
Cooling	Recovered power	kW	1	13,9	16,8	26,3	34,3
	Efficiency	%	1	71,2	67,8	74,5	71,4
Heating	Recovered power	kW	2	12,8	16	23,6	31,6
	Efficiency	%	2	73,6	70,3	76,6	73,7
	Recovered power	kW	3	34,1	42,4	63,2	84,2
	Efficiency	%	3	73,6	70,3	76,6	73,7

*Flow rate corresponding to 30% of the nominal air flow rate.

(1) Outdoor temperature 35°C DB/24°C WB, indoor temperature 27°C DB/19°C WB

(2) Outdoor temperature 7°C DB/6°C WB, indoor temperature 20°C DB/12°C WB

(3) Outdoor temperature -7°C DB/-8°C WB, indoor temperature 20°C DB/12°C WB

Prerformance

The performance data of all configurations are available on www.clivet.com.

Size 20.2 - Configuration CCK-REVO

Cooling performance with 30% of outdoor and exhaust air

FLOW RATE AIR	Ta [°C] DB/WB		Outdoor temperature [°C] DB/WB															
			20/12			25/18			30/22			35/24			40/25			
			kWf	kWs	EER	kWf	kWs	EER	kWf	kWs	EER	kWf	kWs	EER	kWf	kWs	EER	
9500 m³/h	20/15	nom	58,6	43,3	4,73	59,7	41,2	4,23	59,8	40,4	3,81	58,3	41,4	3,33	56,1	43,3	2,92	
		max	67,7	48,3	3,87	68,6	46	3,43	68,4	44,9	3,05	66,5	45,6	2,68	56,1	43,3	2,92	
	23/17	nom	61,4	45	4,87	62,3	43,2	4,36	62,2	42,6	3,91	60,7	43,6	3,43	58,4	45,5	3,01	
		max	70,8	50,1	3,98	71,5	48	3,52	71,1	47,1	3,13	69,2	47,9	2,75	58,4	45,5	3,01	
	26/18	nom	62,7	48,8	4,94	63,6	47,1	4,45	63,5	46,6	3,97	61,9	47,7	3,48	60	48,7	3,06	
		max	72,3	53,9	4,04	73	51,9	3,58	72,5	51,1	3,17	70,6	51,9	2,78	60	48,7	3,06	
	27/19	nom	64,2	48,6	5,06	65	47	4,51	64,8	46,6	4,02	63,1	47,7	3,53	61,1	48,9	3,10	
		max	73,9	53,7	4,08	74,5	51,8	3,62	74	51,1	3,20	72	51,9	2,81	61,1	48,9	3,10	
	30/22	nom	68,7	47,9	5,28	69,3	46,6	4,71	68,8	46,4	4,20	67	47,6	3,68	64,5	49,3	3,23	
		max	79	52,9	4,25	79,4	51,3	3,75	78,6	50,9	3,32	76,3	51,8	2,91	64,5	49,3	3,23	
	13000 m³/h	20/15	nom	61,9	49,2	4,91	62,9	46,7	4,40	62,8	46	3,93	61,1	47,6	3,45	58,6	50,3	3,02
			max	71,9	54,6	3,99	72,7	51,8	3,56	72,3	50,7	3,16	70,1	52	2,77	58,6	50,3	3,02
23/17		nom	64,8	51,5	5,06	65,5	49,4	4,52	65,2	48,8	4,02	63,5	50,5	3,55	60,9	53,4	3,09	
		max	75,2	56,9	4,11	75,7	54,4	3,64	75,1	53,5	3,22	72,8	54,9	2,83	60,9	53,4	3,09	
26/18		nom	66,1	56,4	5,16	66,8	54,5	4,58	66,5	54,1	4,08	64,7	55,8	3,59	63	56,5	3,17	
		max	76,7	61,8	4,17	77,2	59,5	3,69	76,5	58,8	3,26	74,3	60,2	2,87	63	56,5	3,17	
27/19		nom	67,6	56,2	5,24	68,2	54,4	4,67	67,8	54,1	4,13	65,9	55,9	3,64	64	56,9	3,20	
		max	78,4	61,5	4,22	78,8	59,4	3,73	78	58,8	3,31	75,7	60,2	2,90	64	56,9	3,20	
30/22		nom	72,2	55,2	5,47	72,6	53,8	4,87	71,8	53,9	4,30	69,7	55,9	3,79	67,3	57,8	3,32	
		max	83,6	60,4	4,38	83,7	58,7	3,86	82,7	58,5	3,42	80	60,2	2,99	67,3	57,8	3,32	
14000 m³/h		20/15	nom	62,6	50,8	4,97	63,5	48,2	4,44	63,4	47,5	3,96	61,6	49,2	3,46	59,1	52,3	3,03
			max	72,8	56,3	4,04	73,6	53,4	3,59	73,1	52,2	3,18	70,9	53,7	2,79	59,1	52,3	3,03
	23/17	nom	65,5	53,2	5,12	66,2	51	4,57	65,8	50,5	4,06	64	52,4	3,56	61,4	55,5	3,12	
		max	76,1	58,7	4,16	76,6	56,1	3,67	75,9	55,3	3,24	73,6	56,8	2,85	61,4	55,5	3,12	
	26/18	nom	66,8	58,5	5,18	67,5	56,5	4,62	67,1	56,2	4,12	65,3	58	3,61	63,6	58,6	3,18	
		max	77,6	63,9	4,19	78,1	61,5	3,72	77,4	60,9	3,28	75	62,4	2,87	63,6	58,6	3,18	
	27/19	nom	68,3	58,2	5,25	68,9	56,4	4,69	68,4	56,1	4,17	66,5	58,1	3,65	64,6	59	3,23	
		max	79,3	63,6	4,24	79,7	61,4	3,76	78,9	60,8	3,33	76,4	62,5	2,90	64,6	59	3,23	
	30/22	nom	72,9	57,2	5,52	73,2	55,8	4,91	72,4	55,9	4,34	70,3	58,1	3,80	67,8	60,2	3,34	
		max	84,6	62,5	4,41	84,6	60,7	3,88	83,5	60,5	3,44	80,8	62,4	3,00	67,8	60,2	3,34	

Ta = Indoor air temperature D.B/W.B

DB = Dry bulb

WB = Wet bulb

kWf = Cooling capacity in kW

kWs = Sensible cooling capacity (kW)

EER referred only to compressors

All cooling and thermal capacities do not take into account the heat dissipated by the fan motors

Size 20.2 - Configuration CCK-REVO

Heating performance with 30% of outdoor and exhaust air

FLOW RATE AIR	Ta [°C] DB		Outdoor temperature [°C] DB/WB													
			-15/-16		-10/-11		-5/-6		0/1		2/1		7/6		12/11	
			kWt	COP	kWt	COP	kWt	COP	kWt	COP	kWt	COP	kWt	COP	kWt	COP
9500 m³/h	10	nom	36,3	4,23	39,8	4,40	44,8	4,62	44,8	4,62	53,8	4,89	61,2	5,02	69,6	5,08
		max	58,8	4,11	60,4	3,92	64,6	3,85	64,6	3,85	74,1	3,78	83	3,72	93,4	3,65
	15	nom	35,4	3,99	39,1	4,14	44,2	4,33	44,2	4,33	53,2	4,55	60,7	4,63	68,9	4,72
		max	57	3,88	59,1	3,69	63,6	3,59	63,6	3,59	73,4	3,53	82,4	3,48	92,6	3,40
	18	nom	34,8	3,84	38,6	3,97	43,8	4,13	43,8	4,13	52,9	4,34	60,3	4,43	68,5	4,51
		max	55,9	3,73	58,3	3,55	63	3,46	63	3,46	73	3,40	82	3,35	92,2	3,28
	20	nom	34,5	3,75	38,4	3,88	43,6	4,04	43,6	4,04	52,7	4,22	60,1	4,32	68,3	4,38
		max	55,3	3,64	57,8	3,46	62,7	3,37	62,7	3,37	72,7	3,30	81,7	3,25	91,9	3,19
	22	nom	34,2	3,66	38,1	3,77	43,4	3,91	43,4	3,91	52,5	4,10	59,9	4,19	68	4,25
		max	54,6	3,55	57,3	3,37	62,3	3,30	62,3	3,30	72,5	3,22	81,5	3,17	91,6	3,12
	25	nom	33,7	3,53	37,7	3,63	43	3,77	43	3,77	52,2	3,95	59,6	4,03	67,6	4,07
		max	53,7	3,42	56,6	3,25	61,8	3,17	61,8	3,17	72,1	3,09	81,1	3,05	91,1	3,00
13000 m³/h	10	nom	37,3	4,49	40,7	4,72	45,6	5,02	45,6	5,02	54,6	5,41	62,2	5,65	70,8	5,85
		max	62,1	4,50	62,9	4,34	66,5	4,32	66,5	4,32	75,6	4,34	84,5	4,36	95,1	4,34
	15	nom	36,3	4,23	39,9	4,42	44,9	4,67	44,9	4,67	54	5,00	61,5	5,21	70,1	5,39
		max	59,9	4,25	61,3	4,09	65,4	4,04	65,4	4,04	74,8	4,04	83,8	4,05	94,4	4,03
	18	nom	35,7	4,07	39,4	4,25	44,5	4,48	44,5	4,48	53,6	4,79	61,2	4,98	69,7	5,16
		max	58,7	4,08	60,4	3,92	64,7	3,87	64,7	3,87	74,3	3,87	83,4	3,88	93,9	3,85
	20	nom	35,3	3,97	39,1	4,15	44,2	4,33	44,2	4,33	53,4	4,64	61	4,84	69,4	4,99
		max	58	4,00	59,8	3,81	64,3	3,76	64,3	3,76	74	3,76	83,1	3,76	93,7	3,75
	22	nom	34,9	3,87	38,8	4,03	44	4,23	44	4,23	53,2	4,51	60,8	4,71	69,2	4,84
		max	57,2	3,89	59,3	3,73	63,9	3,67	63,9	3,67	73,7	3,65	82,8	3,65	93,4	3,65
	25	nom	34,4	3,73	38,4	3,88	43,6	4,07	43,6	4,07	52,9	4,34	60,4	4,51	68,8	4,65
		max	56,1	3,74	58,5	3,59	63,3	3,52	63,3	3,52	73,3	3,51	82,4	3,51	92,9	3,49
14000 m³/h	10	nom	37,5	4,55	40,9	4,79	45,8	5,11	45,8	5,11	54,8	5,55	62,3	5,82	71,1	6,03
		max	62,9	4,59	63,4	4,43	66,9	4,40	66,9	4,40	75,9	4,46	84,8	4,51	95,5	4,50
	15	nom	36,5	4,28	40,1	4,49	45,1	4,75	45,1	4,75	54,1	5,10	61,7	5,37	70,4	5,54
		max	60,6	4,33	61,8	4,15	65,7	4,11	65,7	4,11	75,1	4,15	84,1	4,16	94,7	4,17
	18	nom	35,9	4,12	39,6	4,32	44,7	4,56	44,7	4,56	53,8	4,89	61,4	5,12	70	5,30
		max	59,3	4,18	60,8	4,00	65	3,94	65	3,94	74,6	3,97	83,6	3,98	94,3	4,00
	20	nom	35,5	4,02	39,2	4,20	44,4	4,44	44,4	4,44	53,5	4,73	61,1	4,97	69,7	5,13
		max	58,5	4,06	60,2	3,88	64,6	3,85	64,6	3,85	74,3	3,87	83,4	3,88	94	3,87
	22	nom	35,1	3,92	38,9	4,09	44,1	4,28	44,1	4,28	53,3	4,63	60,9	4,80	69,4	4,99
		max	57,7	3,95	59,7	3,80	64,2	3,75	64,2	3,75	74	3,76	83,1	3,76	93,7	3,76
	25	nom	34,6	3,77	38,5	3,93	43,8	4,13	43,8	4,13	53	4,42	60,6	4,59	69	4,76
		max	56,7	3,83	58,9	3,66	63,6	3,59	63,6	3,59	73,6	3,61	82,7	3,61	93,3	3,62

Ta = Indoor ambient temperature DB/WB
 DB = Dry bulb
 kWt = Heating capacity supplied (kW)
 COP referred to compressors only

Integrated heating capacities

External exchanger inlet air temperature °C (D.B. / W.B.)	-5 / -5.4	0 / -0.6	5 / 3.9	Other
Heating capacity multiplication coefficient	0,89	0,88	0,94	1

The integrated heating capacity represents the real heating capacity considering the defrost cycles too.

To obtain the integrated heating capacity multiply the heating performance value in kWt (shown in the heating performance tables) by the coefficients indicated in the table.

DB = Dry bulb

WB = Wet bulb

In case of below zero external air temperature with a long period of heat pump operating mode it is necessary to help the evacuation of the water produced during the defrost cycle; this to avoid the formation of ice in the unit basement. Pay attention that the evacuation will not create inconveniences to things or persons.

Prerformance

Size 28.2 - Configuration CCK-REVO

Cooling performance with 30% of outdoor and exhaust air

FLOW RATE AIR	Ta [°C] DB/WB		Outdoor temperature [°C] DB/WB															
			20/12			25/18			30/22			35/24			40/25			
			kWf	kWs	EER	kWf	kWs	EER	kWf	kWs	EER	kWf	kWs	EER	kWf	kWs	EER	
13000 m ³ /h	20/15	nom	77	57,7	5,13	78,8	55,1	4,64	79,4	54,3	4,20	78,4	56	3,70	76,5	59	3,23	
		max	90,3	65,2	3,94	92,5	62,4	3,53	93,2	61,4	3,18	91,8	62,9	2,81	76,5	59	3,23	
	23/17	nom	80,4	59,9	5,32	81,9	57,7	4,79	82,4	57,1	4,31	81,4	59	3,80	79,5	62	3,34	
		max	94,3	67,5	4,06	96,2	65	3,63	96,7	64,3	3,27	95,4	65,8	2,88	79,5	62	3,34	
	26/18	nom	81,9	65	5,39	83,5	62,9	4,85	83,9	62,5	4,37	82,9	64,4	3,87	81,7	66,3	3,42	
		max	96,2	72,7	4,11	98	70,4	3,68	98,5	69,7	3,31	97,2	71,2	2,93	81,7	66,3	3,42	
	27/19	nom	83,7	64,7	5,47	85,2	62,8	4,92	85,6	62,5	4,46	84,5	64,4	3,93	83,2	66,5	3,47	
		max	98,3	72,4	4,18	100	70,2	3,73	100	69,6	3,33	99,1	71,2	2,97	83,2	66,5	3,47	
	30/22	nom	89,1	63,5	5,75	90,5	62	5,17	90,7	62,1	4,68	89,6	64,3	4,13	88	67,1	3,64	
		max	105	71,1	4,38	106	69,3	3,88	106	69,1	3,48	105	71	3,10	88	67,1	3,64	
	17000 m ³ /h	20/15	nom	80,3	64,3	5,32	82	61,3	4,80	82,5	60,5	4,32	81,3	63	3,80	79,4	67,1	3,34
			max	95	72,4	4,08	97	69	3,66	97,5	67,9	3,28	96	70,1	2,90	79,4	67,1	3,34
23/17		nom	83,7	67,1	5,51	85,2	64,6	4,92	85,6	64,2	4,46	84,4	66,8	3,93	82,4	71	3,43	
		max	99,1	75,2	4,20	101	72,3	3,77	101	71,5	3,37	99,6	73,8	2,98	82,4	71	3,43	
26/18		nom	85,3	73,5	5,58	86,8	71,2	5,02	87,1	71	4,51	86	73,7	3,98	85,2	75,3	3,54	
		max	101	81,5	4,26	103	78,9	3,81	103	78,3	3,41	101	80,6	3,01	85,2	75,3	3,54	
27/19		nom	87,1	73,1	5,66	88,5	71	5,09	88,8	71	4,58	87,6	73,7	4,06	86,7	75,7	3,60	
		max	103	81,1	4,31	105	78,7	3,86	105	78,2	3,47	103	80,7	3,06	86,7	75,7	3,60	
30/22		nom	92,6	71,6	5,94	93,9	70,2	5,34	94	70,6	4,80	92,8	73,7	4,26	91,3	77	3,76	
		max	110	79,6	4,51	111	77,7	4,01	111	77,8	3,60	109	80,5	3,19	91,3	77	3,76	
20500 m ³ /h		20/15	nom	82,3	69,7	5,41	83,9	66,3	4,88	84,3	65,6	4,39	83,1	68,7	3,88	81,1	73,7	3,39
			max	97,9	78	4,17	99,7	74,2	3,73	100	73,2	3,34	98,5	76	2,96	81,1	73,7	3,39
	23/17	nom	85,7	73	5,60	87,1	70,2	5,03	87,5	70	4,53	86,2	73,3	3,99	84,1	78,4	3,50	
		max	102	81,3	4,29	104	78,1	3,84	104	77,4	3,44	102	80,4	3,04	84,1	78,4	3,50	
	26/18	nom	87,3	80,5	5,67	88,7	78	5,10	89	78	4,59	87,8	81,4	4,05	87,3	82,6	3,61	
		max	104	88,8	4,35	105	85,9	3,86	106	85,5	3,49	104	88,4	3,08	87,3	82,6	3,61	
	27/19	nom	89,1	80,1	5,75	90,5	77,9	5,17	90,7	78	4,68	89,4	81,5	4,12	88,8	83,3	3,67	
		max	106	88,3	4,40	108	85,6	3,94	108	85,4	3,53	106	88,5	3,13	88,8	83,3	3,67	
	30/22	nom	94,7	78,4	6,03	95,9	76,9	5,42	96	77,7	4,90	94,7	81,5	4,32	93,4	85,1	3,84	
		max	113	86,5	4,59	114	84,5	4,09	114	84,9	3,68	112	88,4	3,26	93,4	85,1	3,84	

Ta = Indoor air temperature D.B/W.B

DB = Dry bulb

WB = Wet bulb

kWf = Cooling capacity in kW

kWs = Sensible cooling capacity (kW)

EER referred only to compressors

All cooling and thermal capacities do not take into account the heat dissipated by the fan motors

Size 28.2 - Configuration CCK-REVO

Heating performance with 30% of outdoor and exhaust air

FLOW RATE AIR	Ta [°C] DB		Outdoor temperature [°C] DB/WB														
			-15/-16		-10/-11		-5/-6		0/1		2/1		7/6		12/11		
			kWt	COP	kWt	COP	kWt	COP	kWt	COP	kWt	COP	kWt	COP	kWt	COP	
13000 m³/h	10	nom	38,6	3,75	49	4,34	58	4,75	58	4,75	71,1	5,23	80,4	5,40	90,3	5,47	
		max	46	3,51	60,3	3,70	74,2	3,86	74,2	3,86	92,6	3,99	105	4,02	119	4,03	
	15	nom	39,3	3,61	49,7	4,14	58	4,46	58	4,46	70,7	4,84	80	5,00	90	5,08	
		max	47,7	3,22	61,5	3,42	75,1	3,58	75,1	3,58	93,1	3,71	106	3,75	119	3,74	
	18	nom	39,5	3,46	49,2	3,97	58	4,30	58	4,30	70,6	4,64	79,9	4,78	89,8	4,85	
		max	48,7	3,06	62,3	3,26	75,7	3,41	75,7	3,41	93,4	3,55	106	3,59	119	3,58	
	20	nom	39,7	3,39	48,9	3,85	58	4,17	58	4,17	70,6	4,50	79,8	4,64	89,7	4,70	
		max	49,3	2,97	62,9	3,16	76,1	3,31	76,1	3,31	93,7	3,44	106	3,49	119	3,49	
	22	nom	39,8	3,32	49,1	3,75	58,1	4,06	58,1	4,06	70,5	4,38	79,7	4,48	89,6	4,55	
		max	50	2,87	63,4	3,06	76,5	3,21	76,5	3,21	93,9	3,35	106	3,38	119	3,39	
	25	nom	40,1	3,18	49,3	3,60	58,2	3,91	58,2	3,91	70,5	4,17	79,6	4,28	89,5	4,34	
		max	51,1	2,75	64,3	2,94	77,1	3,08	77,1	3,08	94,3	3,21	107	3,26	119	3,25	
	17000 m³/h	10	nom	38,3	3,84	48,3	4,51	57,9	5,03	57,9	5,03	71,3	5,66	80,8	5,94	91,1	6,16
			max	44,9	3,77	59,1	4,02	73,2	4,26	73,2	4,26	91,9	4,48	105	4,59	119	4,67
15		nom	38,7	3,69	48,4	4,28	57,9	4,75	57,9	4,75	71	5,26	80,4	5,51	90,5	5,69	
		max	46,4	3,44	60,3	3,70	74	3,92	74	3,92	92,3	4,16	105	4,23	119	4,31	
18		nom	39	3,58	48,6	4,12	57,9	4,60	57,9	4,60	70,8	5,06	80,2	5,28	90,3	5,44	
		max	47,3	3,26	61	3,53	74,5	3,74	74,5	3,74	92,6	3,97	105	4,05	119	4,13	
20		nom	39,2	3,50	48,7	4,06	57,9	4,45	57,9	4,45	70,7	4,91	80,1	5,10	90,1	5,27	
		max	48	3,18	61,5	3,44	74,9	3,64	74,9	3,64	92,8	3,85	105	3,93	119	4,01	
22		nom	39,4	3,43	48,8	3,94	57,9	4,35	57,9	4,35	70,6	4,77	80	4,97	90	5,11	
		max	48,6	3,08	62	3,32	75,3	3,54	75,3	3,54	93	3,75	106	3,84	119	3,89	
25		nom	39,7	3,31	49	3,80	58	4,17	58	4,17	70,6	4,55	79,8	4,75	89,8	4,88	
		max	49,6	2,93	62,8	3,17	75,8	3,38	75,8	3,38	93,3	3,59	106	3,68	119	3,73	
20500 m³/h		10	nom	38,2	3,89	48,2	4,59	57,9	5,22	57,9	5,22	71,5	5,91	81,2	6,25	91,6	6,54
			max	44,2	3,91	58,5	4,21	72,7	4,49	72,7	4,49	91,6	4,77	105	4,93	119	5,06
	15	nom	38,6	3,75	48,3	4,39	57,9	4,91	57,9	4,91	71,1	5,51	80,7	5,81	91	6,07	
		max	45,7	3,57	59,6	3,87	73,4	4,15	73,4	4,15	92	4,42	105	4,57	119	4,69	
	18	nom	38,8	3,63	48,5	4,25	57,8	4,74	57,8	4,74	71	5,30	80,4	5,58	90,6	5,81	
		max	46,6	3,40	60,3	3,70	73,9	3,95	73,9	3,95	92,2	4,23	105	4,38	119	4,47	
	20	nom	39	3,58	48,5	4,15	57,9	4,63	57,9	4,63	70,9	5,14	80,3	5,43	90,4	5,61	
		max	47,2	3,28	60,8	3,60	74,3	3,83	74,3	3,83	92,4	4,11	105	4,23	119	4,34	
	22	nom	39,2	3,50	48,6	4,05	57,9	4,52	57,9	4,52	70,8	5,02	80,2	5,28	90,3	5,47	
		max	47,8	3,19	61,3	3,48	74,6	3,71	74,6	3,71	92,6	3,99	105	4,10	119	4,22	
	25	nom	39,5	3,41	48,8	3,90	57,9	4,35	57,9	4,35	70,7	4,81	80	5,03	90	5,20	
		max	48,8	3,03	62	3,32	75,1	3,56	75,1	3,56	92,9	3,82	105	3,92	119	4,03	

Ta = Indoor ambient temperature DB/WB
 DB = Dry bulb
 kWt = Heating capacity supplied (kW)
 COP referred to compressors only

Integrated heating capacities

External exchanger inlet air temperature °C (D.B. / W.B.)	-5 / -5.4	0 / -0.6	5 / 3.9	Other
Heating capacity multiplication coefficient	0,89	0,88	0,94	1

The integrated heating capacity represents the real heating capacity considering the defrost cycles too.
 To obtain the integrated heating capacity multiply the heating performance value in kWt (shown in the heating performance tables) by the coefficients indicated in the table.
 DB = Dry bulb
 WB = Wet bulb

In case of below zero external air temperature with a long period of heat pump operating mode it is necessary to help the evacuation of the water produced during the defrost cycle; this to avoid the formation of ice in the unit basement. Pay attention that the evacuation will not create inconveniences to things or persons.

Prerformance

Size 40.4 - Configuration CCK-REVO

Cooling performance with 30% of outdoor and exhaust air

FLOW RATE AIR	Ta [°C] DB/WB		Outdoor temperature [°C] DB/WB															
			20/12			25/18			30/22			35/24			40/25			
			kWf	kWs	EER	kWf	kWs	EER	kWf	kWs	EER	kWf	kWs	EER	kWf	kWs	EER	
17000 m ³ /h	20/15	nom	112	79,3	4,32	115	75,7	3,91	115	74,2	3,51	113	75,7	3,10	109	78,7	2,72	
		max	125	86,4	3,77	127	82,2	3,37	127	80,3	3,00	124	81,4	2,64	109	78,7	2,72	
	23/17	nom	118	82,3	4,50	120	79,1	4,04	120	77,9	3,60	118	79,5	3,20	113	82,6	2,78	
		max	130	89,2	3,86	132	85,6	3,45	132	84	3,08	129	85,2	2,70	113	82,6	2,78	
	26/18	nom	120	88,7	4,55	122	85,7	4,08	123	84,7	3,67	120	86,3	3,23	116	89,4	2,84	
		max	133	95,6	3,92	135	92,1	3,50	135	90,8	3,12	131	92	2,72	116	89,4	2,84	
	27/19	nom	123	88,4	4,64	125	85,6	4,15	125	84,7	3,71	122	86,4	3,26	118	89,5	2,86	
		max	136	95,2	3,98	138	92,0	3,55	137	90,7	3,14	134	92,1	2,77	118	89,5	2,86	
	30/22	nom	132	87,2	4,89	134	84,9	4,36	133	84,4	3,88	130	86,4	3,41	126	89,6	3,00	
		max	146	94	4,17	147	91,2	3,68	146	90,4	3,27	143	92	2,88	126	89,6	3,00	
	23000 m ³ /h	20/15	nom	120	89,2	4,55	122	84,9	4,08	122	83,4	3,65	119	85,7	3,21	115	90	2,82
			max	134	96,5	3,94	135	91,7	3,49	135	89,8	3,12	132	91,7	2,74	115	90	2,82
23/17		nom	126	92,9	4,72	127	89,2	4,19	127	88,1	3,75	124	90,6	3,30	120	95	2,91	
		max	140	100	4,06	141	96,0	3,60	141	94,4	3,20	137	96,6	2,81	120	95	2,91	
26/18		nom	128	101	4,78	130	97,7	4,28	130	96,8	3,81	127	99,4	3,36	122	104	2,93	
		max	142	108	4,09	144	104,0	3,65	143	103	3,23	140	105	2,85	122	104	2,93	
27/19		nom	131	101	4,85	133	97,5	4,35	132	96,8	3,85	129	99,5	3,39	124	104	2,97	
		max	146	108	4,17	147	104,0	3,68	146	103	3,27	142	105	2,86	124	104	2,97	
30/22		nom	140	99,1	5,09	142	96,6	4,55	141	96,4	4,04	137	99,4	3,54	132	104	3,10	
		max	156	106	4,35	157	103,0	3,85	155	103	3,39	151	105	2,98	132	104	3,10	
26000 m ³ /h		20/15	nom	123	93,6	4,64	125	89,0	4,15	125	87,6	3,72	122	90,4	3,27	117	95,3	2,85
			max	137	101	3,99	139	96,0	3,56	138	94,1	3,16	134	96,5	2,76	117	95,3	2,85
	23/17	nom	128	97,8	4,78	130	93,8	4,28	130	92,8	3,81	127	95,8	3,36	122	101	2,94	
		max	143	105	4,11	144	101,0	3,64	144	99,2	3,24	140	102	2,85	122	101	2,94	
	26/18	nom	131	107	4,85	133	103,0	4,35	132	102	3,85	129	105	3,39	124	110	2,97	
		max	146	114	4,17	147	110,0	3,68	146	109	3,27	142	112	2,86	124	110	2,97	
	27/19	nom	134	106	4,94	135	103,0	4,38	135	102	3,91	132	106	3,46	126	111	2,99	
		max	149	114	4,22	150	110,0	3,73	149	109	3,31	145	112	2,91	126	111	2,99	
	30/22	nom	143	105	5,16	144	102,0	4,59	143	102	4,07	139	106	3,57	134	111	3,13	
		max	159	112	4,39	160	109,0	3,88	158	108	3,43	154	112	3,01	134	111	3,13	

Ta = Indoor air temperature D.B/W.B

DB = Dry bulb

WB = Wet bulb

kWf = Cooling capacity in kW

kWs = Sensible cooling capacity (kW)

EER referred only to compressors

All cooling and thermal capacities do not take into account the heat dissipated by the fan motors

Size 40.4 - Configurazione CCK-REVO

Heating performance with 30% of outdoor and exhaust air

FLOW RATE AIR	Ta [°C] DB		Outdoor temperature [°C] DB/WB														
			-15/-16		-10/-11		-5/-6		0/1		2/1		7/6		12/11		
			kWt	COP	kWt	COP	kWt	COP	kWt	COP	kWt	COP	kWt	COP	kWt	COP	
17000 m ³ /h	10	nom	75,7	3,90	82,6	3,97	92,6	4,10	92,6	4,10	111	4,22	126	4,23	143	4,22	
		max	115	3,77	119	3,54	127	3,40	127	3,40	146	3,25	163	3,14	183	3,03	
	15	nom	73,8	3,67	81,1	3,74	91,3	3,82	91,3	3,82	110	3,93	125	3,94	142	3,94	
		max	112	3,57	116	3,31	125	3,18	125	3,18	145	3,06	162	2,95	182	2,86	
	18	nom	72,7	3,55	80,2	3,60	90,7	3,69	90,7	3,69	109	3,76	124	3,78	141	3,78	
		max	110	3,44	115	3,21	124	3,07	124	3,07	144	2,94	161	2,84	181	2,75	
	20	nom	72	3,46	79,7	3,51	90,2	3,59	90,2	3,59	109	3,68	124	3,69	140	3,66	
		max	108	3,33	114	3,14	123	2,99	123	2,99	143	2,85	161	2,78	180	2,69	
	22	nom	71,3	3,38	79,2	3,43	89,8	3,49	89,8	3,49	108	3,56	124	3,60	140	3,59	
		max	107	3,26	113	3,05	123	2,93	123	2,93	143	2,80	161	2,72	180	2,63	
	25	nom	70,4	3,26	78,4	3,31	89,2	3,38	89,2	3,38	108	3,45	123	3,46	139	3,45	
		max	105	3,13	111	2,93	122	2,82	122	2,82	142	2,69	160	2,62	179	2,54	
	23000 m ³ /h	10	nom	78,1	4,18	85	4,30	94,4	4,50	94	4,50	112	4,71	128	4,85	145	4,90
			max	122	4,19	124	3,95	131	3,84	131	3,84	149	3,76	166	3,70	187	3,63
15		nom	76	3,94	83	4,05	93	4,19	93	4,19	111	4,37	127	4,50	144	4,56	
		max	118	3,95	121	3,71	129	3,60	129	3,60	147	3,50	165	3,45	186	3,39	
18		nom	74,8	3,80	82	3,89	92,3	4,03	92	4,03	111	4,22	126	4,30	143	4,35	
		max	116	3,82	119	3,56	128	3,47	128	3,47	147	3,38	164	3,31	185	3,26	
20		nom	74	3,70	81	3,79	91,8	3,92	92	3,92	110	4,07	126	4,19	143	4,24	
		max	114	3,71	118	3,48	127	3,38	127	3,38	146	3,28	164	3,23	184	3,17	
22		nom	73,3	3,61	81	3,69	91,3	3,82	91	3,82	110	3,99	125	4,06	142	4,10	
		max	113	3,63	117	3,40	126	3,28	126	3,28	146	3,21	163	3,14	184	3,10	
25		nom	72,2	3,49	80	3,56	90,6	3,68	91	3,68	109	3,81	125	3,91	142	3,97	
		max	111	3,50	115	3,26	125	3,16	125	3,16	145	3,09	163	3,04	183	2,98	
26000 m ³ /h		10	nom	79	4,27	86	4,43	95,1	4,64	95	4,64	113	4,91	129	5,10	146	5,18
			max	125	4,36	126	4,12	132	4,00	132	4,00	150	3,96	167	3,92	188	3,87
	15	nom	76,8	4,02	84	4,14	93,7	4,34	94	4,34	112	4,57	127	4,69	145	4,80	
		max	121	4,12	123	3,87	130	3,75	130	3,75	148	3,68	166	3,66	187	3,61	
	18	nom	75,6	3,88	83	4,00	92,8	4,14	93	4,14	111	4,37	127	4,50	144	4,59	
		max	118	3,95	121	3,71	129	3,61	129	3,61	148	3,55	165	3,50	186	3,46	
	20	nom	74,8	3,78	82	3,89	92,3	4,05	92	4,05	111	4,25	126	4,36	144	4,46	
		max	116	3,84	120	3,63	128	3,51	128	3,51	147	3,45	165	3,42	186	3,38	
	22	nom	74	3,70	81	3,79	91,8	3,94	92	3,94	110	4,12	126	4,24	143	4,32	
		max	115	3,76	119	3,54	127	3,41	127	3,41	147	3,37	164	3,31	185	3,28	
	25	nom	72,9	3,56	81	3,66	91,1	3,78	91	3,78	110	3,97	125	4,06	143	4,16	
		max	113	3,63	117	3,40	126	3,30	126	3,30	146	3,23	164	3,20	184	3,16	

Ta = Indoor ambient temperature DB/WB
 DB = Dry bulb
 kWt = Heating capacity supplied (kW)
 COP referred to compressors only

Integrated heating capacities

External exchanger inlet air temperature °C (D.B. / W.B.)	-5 / -5.4	0 / -0.6	5 / 3.9	Other
Heating capacity multiplication coefficient	0,89	0,88	0,94	1

The integrated heating capacity represents the real heating capacity considering the defrost cycles too.

To obtain the integrated heating capacity multiply the heating performance value in kWt (shown in the heating performance tables) by the coefficients indicated in the table.

DB = Dry bulb

WB = Wet bulb

In case of below zero external air temperature with a long period of heat pump operating mode it is necessary to help the evacuation of the water produced during the defrost cycle; this to avoid the formation of ice in the unit basement. Pay attention that the evacuation will not create inconveniences to things or persons.

Prerformance

Size 56.4 - Configuration CCK-REVO

Cooling performance with 30% of outdoor and exhaust air

FLOW RATE AIR	Ta [°C] DB/WB		Outdoor temperature [°C] DB/WB															
			20/12			25/18			30/22			35/24			40/25			
			kWf	kWs	EER	kWf	kWs	EER	kWf	kWs	EER	kWf	kWs	EER	kWf	kWs	EER	
22000 m ³ /h	20/15	nom	147	131	4,38	151	131	3,95	153	132	3,57	151	132	3,15	148	131	2,76	
		max	159	141	3,73	164	142	3,37	165	142	3,02	163	142	2,66	148	131	2,76	
	23/17	nom	154	136	4,53	157	137	4,07	159	137	3,67	157	137	3,24	153	137	2,83	
		max	166	147	3,85	170	147	3,45	172	148	3,11	170	147	2,75	153	137	2,83	
	26/18	nom	157	141	4,60	161	142	4,15	162	142	3,72	160	142	3,29	156	142	2,87	
		max	170	152	3,92	174	153	3,51	175	153	3,15	173	153	2,79	156	142	2,87	
	27/19	nom	160	143	4,66	164	144	4,21	165	144	3,78	163	144	3,33	159	144	2,92	
		max	174	154	3,98	177	155	3,55	178	155	3,18	176	155	2,82	159	144	2,92	
	30/22	nom	171	149	4,89	174	150	4,38	175	150	3,95	173	150	3,49	169	150	3,06	
		max	185	160	4,15	188	161	3,70	189	162	3,32	187	161	2,95	169	150	3,06	
	32000 m ³ /h	20/15	nom	159	144	4,65	162	144	4,15	164	144	3,76	161	144	3,30	158	144	2,91
			max	173	155	3,97	177	156	3,55	178	156	3,18	175	155	2,80	158	144	2,91
23/17		nom	165	150	4,77	169	150	4,29	170	150	3,86	167	150	3,39	163	151	2,97	
		max	180	162	4,07	184	162	3,65	185	162	3,27	182	162	2,89	163	151	2,97	
26/18		nom	169	156	4,86	172	156	4,34	173	156	3,91	171	157	3,46	167	157	3,04	
		max	184	168	4,13	187	168	3,69	188	169	3,31	185	169	2,92	167	157	3,04	
27/19		nom	172	158	4,91	175	158	4,40	176	159	3,96	174	159	3,51	170	159	3,08	
		max	188	170	4,20	191	171	3,75	192	171	3,36	189	171	2,97	170	159	3,08	
30/22		nom	183	164	5,13	186	164	4,60	186	165	4,12	184	165	3,67	180	165	3,23	
		max	200	177	4,37	202	177	3,88	203	177	3,49	200	177	3,10	180	165	3,23	
34000 m ³ /h		20/15	nom	160	146	4,66	164	146	4,19	165	146	3,78	163	146	3,33	159	146	2,92
			max	175	158	4,00	179	158	3,58	180	158	3,21	177	158	2,83	159	146	2,92
	23/17	nom	167	152	4,81	170	152	4,30	171	152	3,88	169	153	3,43	165	153	3,01	
		max	182	164	4,10	185	164	3,66	186	164	3,29	184	164	2,91	165	153	3,01	
	26/18	nom	170	158	4,87	173	159	4,36	174	159	3,93	172	159	3,47	168	159	3,05	
		max	186	171	4,16	189	171	3,71	190	171	3,33	187	171	2,94	168	159	3,05	
	27/19	nom	174	160	4,96	177	161	4,44	178	161	4,00	175	161	3,52	171	162	3,09	
		max	190	173	4,22	193	173	3,77	193	173	3,37	191	173	2,99	171	162	3,09	
	30/22	nom	185	166	5,18	188	167	4,64	188	167	4,17	186	168	3,66	181	168	3,24	
		max	202	179	4,40	204	180	3,92	205	180	3,52	202	180	3,12	181	168	3,24	

Ta = Indoor air temperature D.B/W.B

DB = Dry bulb

WB = Wet bulb

kWf = Cooling capacity in kW

kWs = Sensible cooling capacity (kW)

EER referred only to compressors

All cooling and thermal capacities do not take into account the heat dissipated by the fan motors

Size 56.4 - Configuration CCK-REVO

Heating performance with 30% of outdoor and exhaust air

FLOW RATE AIR	Ta [°C] DB		Outdoor temperature [°C] DB/WB														
			-15/-16		-10/-11		-5/-6		0/1		2/1		7/6		12/11		
			kWt	COP	kWt	COP	kWt	COP	kWt	COP	kWt	COP	kWt	COP	kWt	COP	
22000 m ³ /h	10	nom	77,9	3,36	98,6	3,73	119	4,02	119	4,02	147	4,25	167	4,30	189	4,30	
		max	90,3	3,07	120	3,16	148	3,22	148	3,22	185	3,26	210	3,23	236	3,17	
	15	nom	79,5	3,15	99,7	3,50	120	3,76	120	3,76	148	3,97	167	3,98	189	3,98	
		max	94,4	2,80	123	2,90	151	2,99	151	2,99	187	3,03	212	3,02	238	2,97	
	18	nom	80,5	3,05	100	3,36	121	3,62	121	3,62	148	3,79	168	3,83	189	3,80	
		max	97	2,66	125	2,77	152	2,85	152	2,85	188	2,90	212	2,88	238	2,85	
	20	nom	81,2	2,97	101	3,28	121	3,51	121	3,51	148	3,67	168	3,71	189	3,69	
		max	98,8	2,58	127	2,70	153	2,77	153	2,77	189	2,83	213	2,81	239	2,79	
	22	nom	81,9	2,90	102	3,20	121	3,40	121	3,40	148	3,56	168	3,60	189	3,59	
		max	101	2,51	128	2,61	155	2,71	155	2,71	189	2,74	214	2,74	239	2,71	
	25	nom	83	2,79	102	3,04	122	3,27	122	3,27	149	3,43	168	3,44	189	3,43	
		max	103	2,38	130	2,50	156	2,59	156	2,59	191	2,65	215	2,64	241	2,63	
	32000 m ³ /h	10	nom	76,3	3,55	97,3	4,07	118	4,49	118	4,49	147	4,92	168	5,12	189	5,21
			max	85,5	3,45	115	3,63	143	3,77	143	3,77	181	3,92	207	3,97	234	3,98
15		nom	77,7	3,36	98,2	3,84	119	4,22	119	4,22	147	4,58	167	4,72	189	4,82	
		max	89,2	3,14	118	3,34	146	3,49	146	3,49	182	3,63	208	3,68	235	3,70	
18		nom	78,6	3,25	98,8	3,69	119	4,03	119	4,03	147	4,38	167	4,53	189	4,61	
		max	91,5	2,98	120	3,18	147	3,33	147	3,33	183	3,47	209	3,54	235	3,54	
20		nom	79,2	3,18	99,2	3,59	120	3,95	120	3,95	147	4,25	167	4,39	189	4,48	
		max	93,1	2,88	121	3,09	148	3,23	148	3,23	184	3,38	209	3,43	235	3,44	
22		nom	79,9	3,11	99,7	3,50	120	3,83	120	3,83	147	4,13	167	4,26	189	4,34	
		max	94,6	2,79	122	2,98	149	3,14	149	3,14	184	3,28	210	3,34	236	3,36	
25		nom	80,9	3,00	100	3,36	120	3,67	120	3,67	148	3,98	167	4,07	189	4,15	
		max	97	2,66	124	2,85	150	3,00	150	3,00	186	3,16	210	3,20	236	3,22	
34000 m ³ /h		10	nom	76,2	3,58	97,2	4,12	118	4,56	118	4,56	147	5,02	168	5,23	190	5,37
			max	85	3,51	114	3,69	143	3,86	143	3,86	180	4,01	207	4,09	234	4,11
	15	nom	77,5	3,40	98	3,87	119	4,28	119	4,28	147	4,67	167	4,83	189	4,95	
		max	88,6	3,19	117	3,39	145	3,56	145	3,56	182	3,73	208	3,80	234	3,80	
	18	nom	78,4	3,28	98,6	3,73	119	4,10	119	4,10	147	4,47	167	4,63	189	4,74	
		max	90,8	3,03	119	3,23	146	3,40	146	3,40	183	3,57	208	3,62	235	3,65	
	20	nom	79	3,21	98,9	3,64	119	3,98	119	3,98	147	4,34	167	4,49	189	4,59	
		max	92,4	2,92	120	3,13	147	3,29	147	3,29	183	3,46	209	3,53	235	3,54	
	22	nom	79,6	3,13	99,4	3,54	120	3,90	120	3,90	147	4,21	167	4,35	189	4,46	
		max	93,9	2,84	121	3,03	148	3,20	148	3,20	184	3,37	209	3,42	235	3,45	
	25	nom	80,6	3,02	100	3,40	120	3,74	120	3,74	147	4,03	167	4,16	189	4,27	
		max	96,3	2,70	123	2,89	150	3,07	150	3,07	185	3,23	210	3,29	236	3,32	

Ta = Indoor ambient temperature DB/WB
 DB = Dry bulb
 kWt = Heating capacity supplied (kW)
 COP referred to compressors only

Integrated heating capacities

External exchanger inlet air temperature °C (D.B. / W.B.)	-5 / -5.4	0 / -0.6	5 / 3.9	Other
Heating capacity multiplication coefficient	0,89	0,88	0,94	1

The integrated heating capacity represents the real heating capacity considering the defrost cycles too.
 To obtain the integrated heating capacity multiply the heating performance value in kWt (shown in the heating performance tables) by the coefficients indicated in the table.
 DB = Dry bulb
 WB = Wet bulb

In case of below zero external air temperature with a long period of heat pump operating mode it is necessary to help the evacuation of the water produced during the defrost cycle; this to avoid the formation of ice in the unit basement. Pay attention that the evacuation will not create inconveniences to things or persons.

Dimensional drawings

Size 20.2 - Version CAK / CBK / CBK-G / CCK-REVO

DAA800001_00
DATA/DATE 13/08/2021

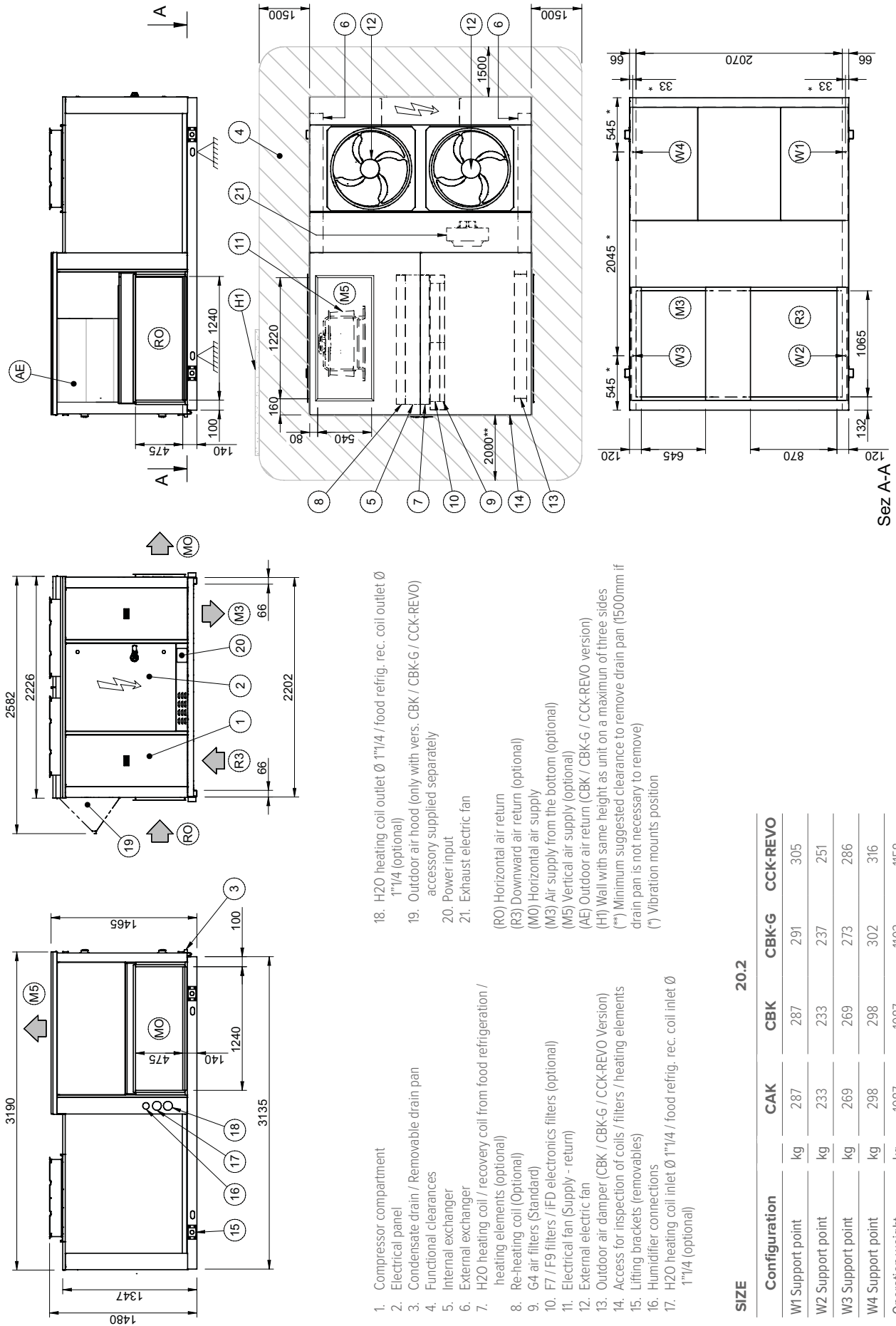

- 1. Compressor compartment
- 2. Electrical panel
- 3. Condensate drain / Removable drain pan
- 4. Functional clearances
- 5. Internal exchanger
- 6. External exchanger
- 7. H2O heating coil / recovery coil from food refrigeration / heating elements (optional)
- 8. Re-heating coil (Optional)
- 9. G4 air filters (Standard)
- 10. F7 / F9 filters / IFD electronics filters (optional)
- 11. Electrical fan (Supply - return)
- 12. External electric fan
- 13. Outdoor air damper (CBK / CBK-G / CCK-REVO Version)
- 14. Access for inspection of coils / filters / heating elements
- 15. Lifting brackets (removables)
- 16. Humidifier connections
- 17. H2O heating coil inlet Ø 1"1/4 / food refrig. rec. coil inlet Ø 1"1/4 (optional)
- 18. H2O heating coil outlet Ø 1"1/4 / food refrig. rec. coil outlet Ø 1"1/4 (optional)
- 19. Outdoor air hood (only with vers. CBK / CBK-G / CCK-REVO) accessory supplied separately
- 20. Power input
- 21. Exhaust electric fan
- (RO) Horizontal air return
- (R3) Downward air return (optional)
- (MO) Horizontal air return (optional)
- (M3) Air supply from the bottom (optional)
- (M5) Vertical air supply (optional)
- (AE) Outdoor air return (CBK / CBK-G / CCK-REVO version)
- (H1) Wall with same height as unit on a maximum of three sides
- (**) Minimum suggested clearance to remove drain pan (1500mm if drain pan is not necessary to remove)
- (*) Vibration mounts position

20.2

Configuration	CAK	CBK	CBK-G	CCK-REVO
W1 Support point	kg 287	287	291	305
W2 Support point	kg 233	233	237	251
W3 Support point	kg 269	269	273	286
W4 Support point	kg 298	298	302	316
Operation weight	kg 1087	1087	1103	1158
Shipping weight	kg 1114	1114	1130	1185

Optional accessories may result in a substantial variation of the weight show in table

Size 20.2 CAK / CBK / CBK-G / CCK-REVO Version
GC01X - GC08X - GC09X

DAA800001_GC01X-GC08X-GC09X_01
DATA/DATE 13/08/2021

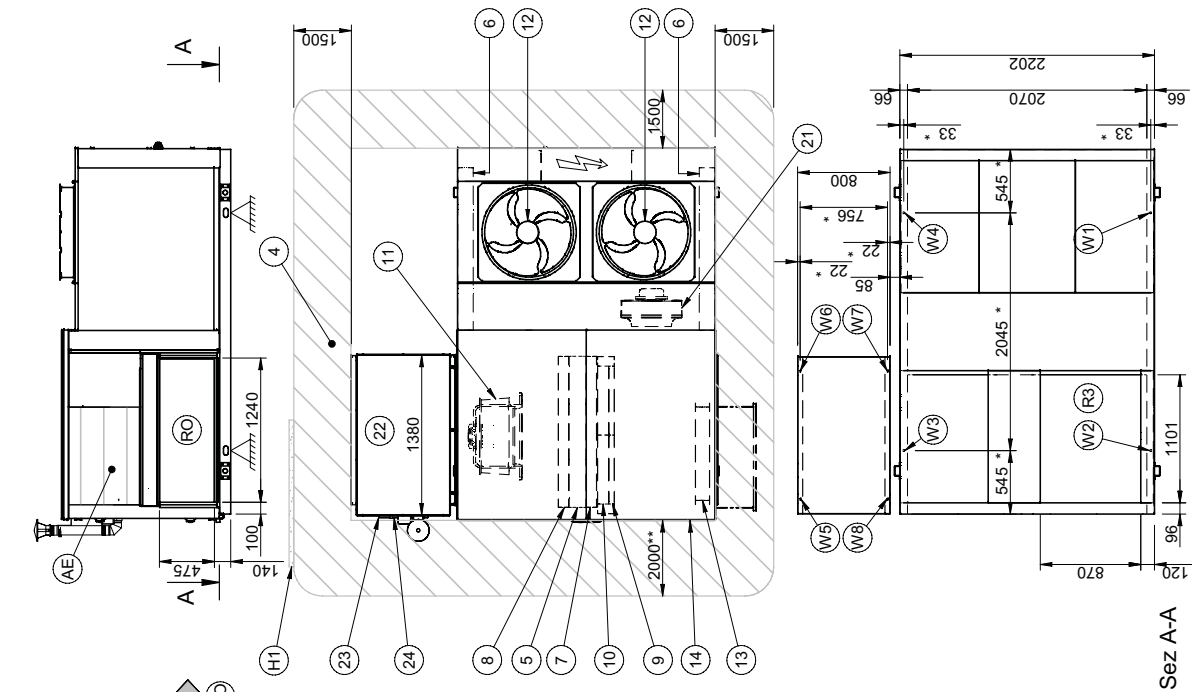

1. Compressor compartment
 2. Electrical panel
 3. Condensate drain / Removable drain pan
 4. Functional clearances
 5. Internal exchanger
 6. External exchanger
 7. H2O heating coil / recovery coil from food refrigeration / heating elements (optional)
 8. Re-heating coil (Optional)
 9. G4 air filters (Standard)
 10. F7 / F9 filters / iFD electronics filters (optional)
 11. Electrical fan (Supply - return)
 12. External electric fan
 13. Outdoor air damper (CBK / CBK-G / CCK-REVO Version)
 14. Access for inspection of coils / filters / heating elements
 15. Lifting brackets (removables)
 16. Humidifier connections
 17. H2O heating coil inlet Ø 1"1/4 / food refriger. rec. coil inlet Ø 1"1/4 (optional)
 18. H2O heating coil outlet Ø 1"1/4 / food refriger. rec. coil outlet Ø 1"1/4 (optional)
 19. Outdoor air hood (only with vers. CBK / CBK-G / CCK-REVO) accessory supplied separately
 20. Power input
 21. Exhaust electric fan
 22. Gas module
 23. Gas connection
 24. Condensate drain (only for condensing module)
- (RO) Horizontal air return
(R3) Downward air return (optional)
(W0) Horizontal air supply
(AE) Outdoor air return (CBK / CBK-G / CCK-REVO version)
(H1) Wall with same height as unit on a maximum of three sides
(**) Minimum suggested clearance to remove drain pan (1500mm if drain pan is not necessary to remove)
(*) Vibration mounts position

WEIGHT DISTRIBUTION

20.2

Configuration	CAK	CBK	CBK-G	CCK-REVO	WEIGHT DISTRIBUTION GAS MODULE
W1 Support point	287	287	291	305	W5 Support point
W2 Support point	233	233	237	251	W6 Support point
W3 Support point	269	269	273	286	W7 Support point
W4 Support point	298	298	302	316	W8 Support point
Operation weight	1087	1087	1103	1158	Operation weight
Shipping weight	1114	1114	1130	1185	Shipping weight

Optional accessories may result in a substantial variation of the weight show in table

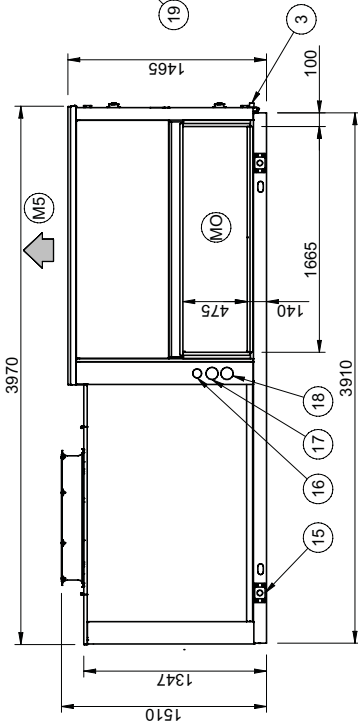
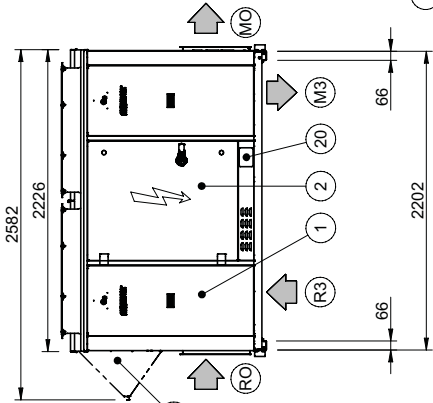
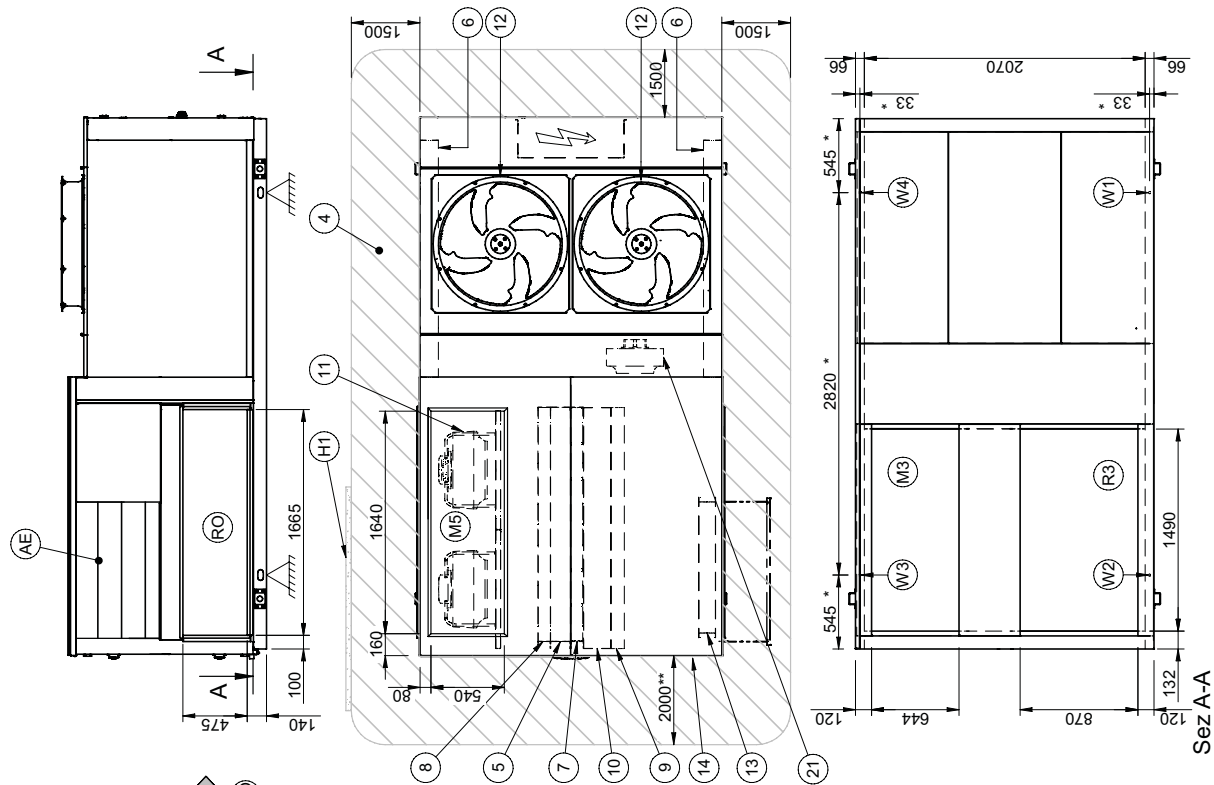

1. Compressor compartment
 2. Electrical panel
 3. Condensate drain / Removable drain pan
 4. Functional clearances
 5. Internal exchanger
 6. External exchanger
 7. H₂O heating coil / recovery coil from food refrigeration / heating elements (optional)
 8. Re-heating coil (Optional)
 9. G4 air filters (Standard)
 10. F7 / F9 filters / IFD electronics filters (optional)
 11. Electrical fan (Supply - return)
 12. External electric fan
 13. Outdoor air damper (CBK / CBK-G / CCK-REVO Version)
 14. Access for inspection of coils / filters / heating elements
 15. Lifting brackets (removable)
 16. Humidifier connections
 17. H₂O heating coil input Ø 1"1/4 / recovery coil from food refrigeration, input Ø 1"1/4 (optional)
 18. H₂O heating coil output Ø 1"1/4 / recovery coil from food refrigeration, output Ø 1"1/4 (optional)
 19. Outdoor air hood (only with vers. CBK / CBK-G / CCK-REVO) accessory supplied separately
 20. Power input
 21. Exhaust electric fan
- (RO) Horizontal air return
(R3) Downward air return (optional)
(M0) Horizontal air supply
(M3) Air supply from the bottom (optional)
(M5) Vertical air supply (optional)
(AE) Outdoor air return (CBK / CBK-G / CCK-REVO version)
(H1) Wall with same height as unit on a maximum of three sides
(**) Minimum suggested clearance to remove drain pan (1500mm if drain pan is not necessary to remove)
(*) Vibration mounts position

SIZE **28.2**

Configuration	CAK	CBK	CBK-G	CCK-REVO
W1 Support point	kg 312	312	316	330
W2 Support point	kg 258	258	262	276
W3 Support point	kg 294	294	298	311
W4 Support point	kg 323	323	327	341
Operation weight	kg 1187	1187	1203	1258
Shipping weight	kg 1214	1214	1230	1285

Optional accessories may result in a substantial variation of the weight show in table

Dimensional drawings

Size 28.2 CAK / CBK / CBK-G / CCK-REVO Version
GC01X - GC08X - GC09X - GC010X - GC011X

DAA800002_GC01X-GC08X-GC09X-GC010X-
GC011X_01
DATA/DATE 11/08/2021

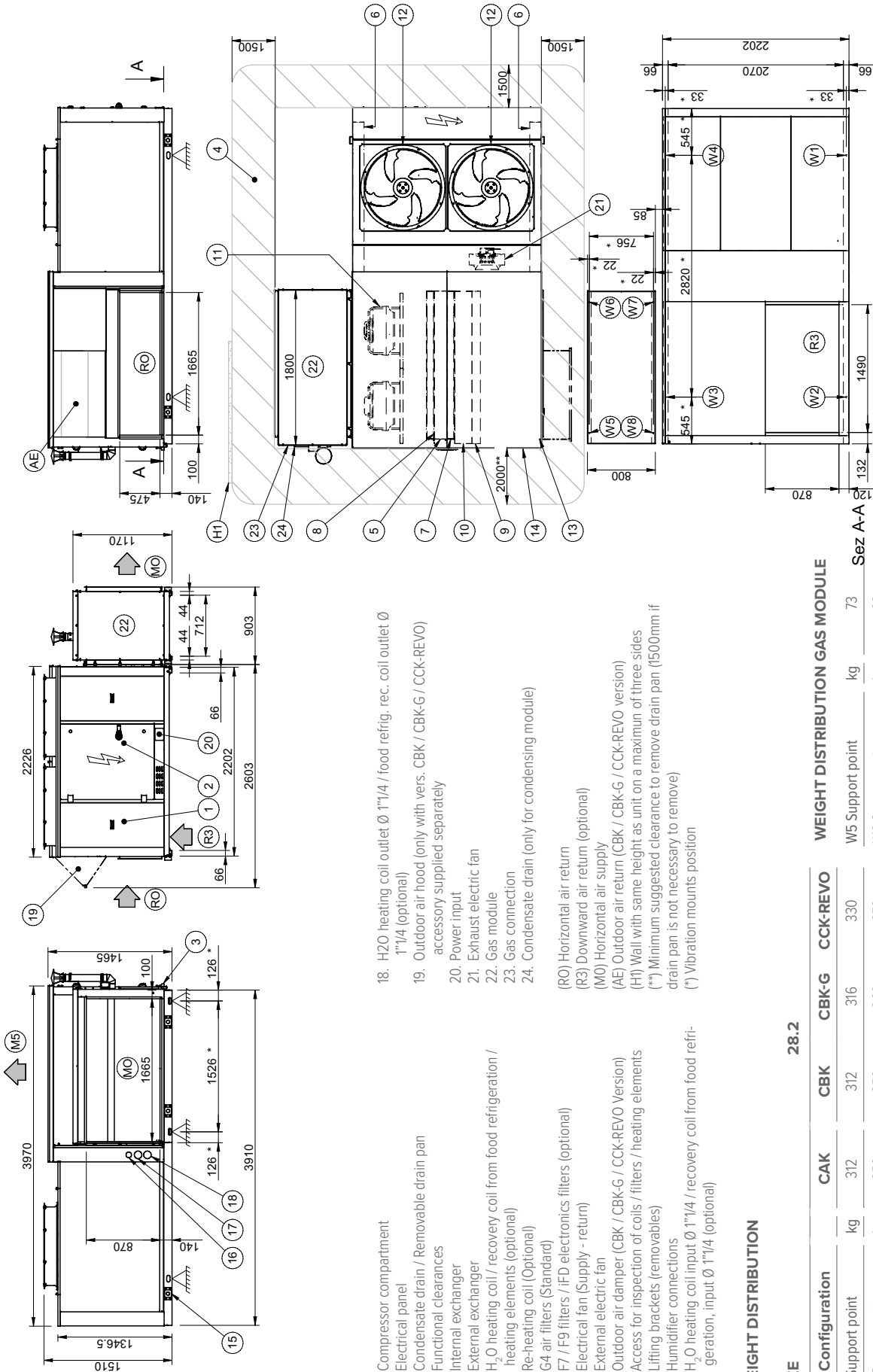

- 1. Compressor compartment
 - 2. Electrical panel
 - 3. Condensate drain / Removable drain pan
 - 4. Functional clearances
 - 5. Internal exchanger
 - 6. External exchanger
 - 7. H₂O heating coil / recovery coil from food refrigeration / heating elements (optional)
 - 8. Re-heating coil (Optional)
 - 9. G4 air filters (Standard)
 - 10. F7 / F9 filters / I/ED electronics filters (optional)
 - 11. Electrical fan (Supply - return)
 - 12. External electric fan
 - 13. Outdoor air damper (CBK / CBK-G / CCK-REVO Version)
 - 14. Access for inspection of coils / filters / heating elements
 - 15. Lifting brackets (removable)
 - 16. Humidifier connections
 - 17. H₂O heating coil input Ø 1"1/4 / recovery coil from food refrigeration, input Ø 1"1/4 (optional)
 - 18. H2O heating coil outlet Ø 1"1/4 / food refriger. rec. coil outlet Ø 1"1/4 (optional)
 - 19. Outdoor air hood (only with vers. CBK / CBK-G / CCK-REVO) accessory supplied separately
 - 20. Power input
 - 21. Exhaust electric fan
 - 22. Gas module
 - 23. Gas connection
 - 24. Condensate drain (only for condensing module)
- (RO) Horizontal air return
(R3) Downward air return (optional)
(MO) Horizontal air supply
(AE) Outdoor air return (CBK / CBK-G / CCK-REVO version)
(H1) Wall with same height as unit on a maximum of three sides
(**) Minimum suggested clearance to remove drain pan (1500mm if drain pan is not necessary to remove)
(*) Vibration mounts position

WEIGHT DISTRIBUTION

28.2

Configuration	CAK	CBK	CBK-G	CCK-REVO	WEIGHT DISTRIBUTION GAS MODULE	
W1 Support point	kg 312	312	316	330	W5 Support point	kg 73
W2 Support point	kg 258	258	262	276	W6 Support point	kg 62
W3 Support point	kg 294	294	298	311	W7 Support point	kg 62
W4 Support point	kg 323	323	327	341	W8 Support point	kg 73
Operation weight	kg 1187	1187	1203	1258	Operation weight	kg 270
Shipping weight	kg 1214	1214	1230	1285	Shipping weight	kg 270

Optional accessories may result in a substantial variation of the weight show in table

Size 28.2 CBK - G Version + Rotary recovery module

DAA800002_EW12X_01
DATA/DATE 11/08/2021

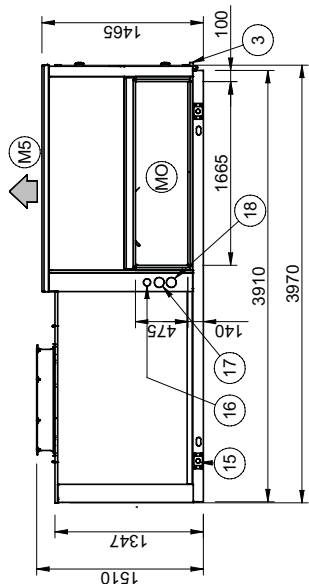
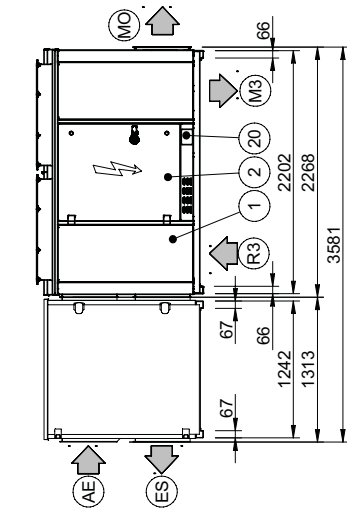
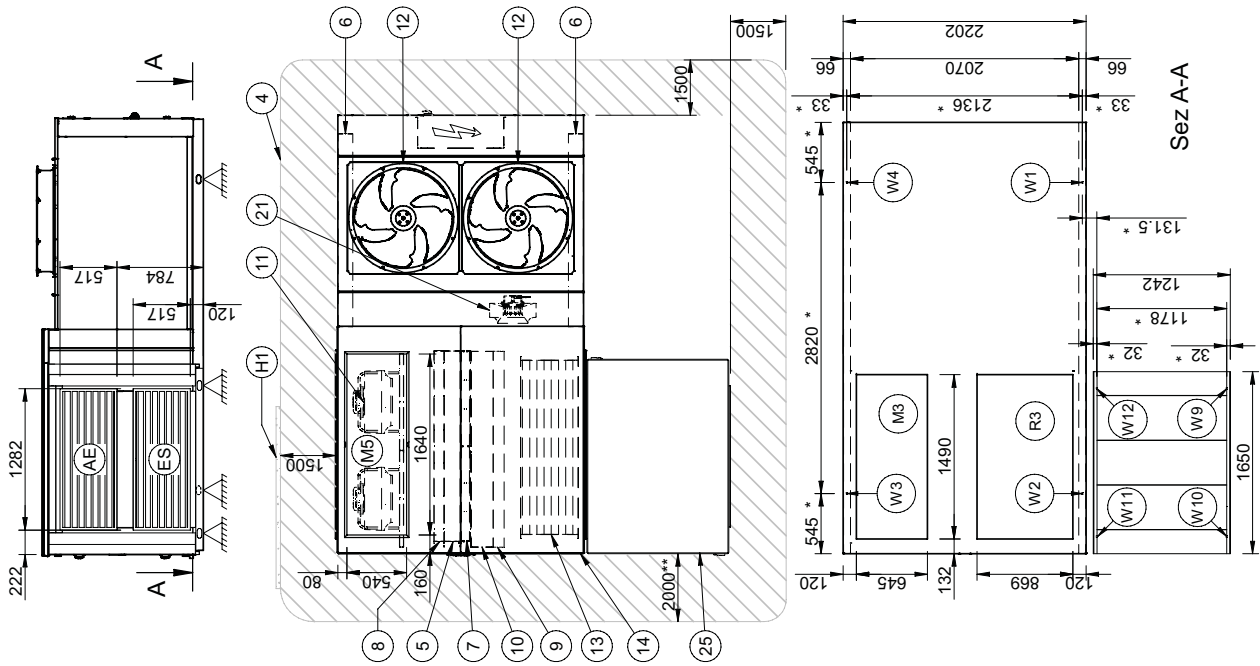

19. Outdoor air return cap (Not available with enthalpic wheel)
 20. Power input
 21. Exhaust electric fan
 22. Gas module (Drawing dedicated)
 23. Gas connection (Drawing dedicated)
 24. Condensate drain (Drawing dedicated)
 25. Enthalpy wheel
- (RO) Horizontal air return (Not available with enthalpic wheel)
 (R3) Downward air return (optional)
 (MO) Horizontal air return (optional)
 (M3) Air supply from the bottom (optional)
 (M5) Vertical air supply (optional)
 (AE) Outdoor air return (CBK / CBK-G / CCK-REVO version)
 (ES) Exhausted air expulsion
 (H1) Wall with same height as unit on a maximum of three sides
 (*) Vibration mounts position
 (**) Minimum suggested clearance to remove drain pan (1500mm: if drain pan is not necessary to remove)

1. Compressor compartment
2. Electrical panel
3. Condensate drain / Removable drain pan
4. Functional clearances
5. Internal exchanger
6. External exchanger
7. H₂O heating coil / recovery coil from food refrigeration / heating elements (optional)
8. Re-heating coil (Optional)
9. G4 air filters (Standard)
10. F7 / F9 filters / IFD electronics filters (optional)
11. Electrical fan (Supply - return)
12. External electric fan
13. Outdoor air damper (CBK / CBK-G / CCK-REVO Version)
14. Access for inspection of coils / filters / heating elements
15. Lifting brackets (removable)
16. Humidifier connections
17. H₂O heating coil input Ø 1"1/4 / recovery coil from food refrigeration, input Ø 1"1/4 (optional)
18. H₂O heating coil output Ø 1"1/4 / recovery coil from food refrigeration, output Ø 1"1/4 (optional)

WEIGHT DISTRIBUTION

SIZE	Configuration	CBK-G	WEIGHT DISTRIBUTION - ROTARY RECOVERY MODULE
	W1 Support point	kg 316	kg 135
	W2 Support point	kg 262	kg 135
	W3 Support point	kg 298	kg 120
	W4 Support point	kg 327	kg 120
	Operation weight	kg 1203	kg 510
	Shipping weight	kg 1230	kg 510

Optional accessories may result in a substantial variation of the weight show in table

Dimensional drawings

Size 40.4 - Version CAK / CBK / CBK-G / CCK-REVO

DAA800003_00
DATA/DATE 01/06/2022

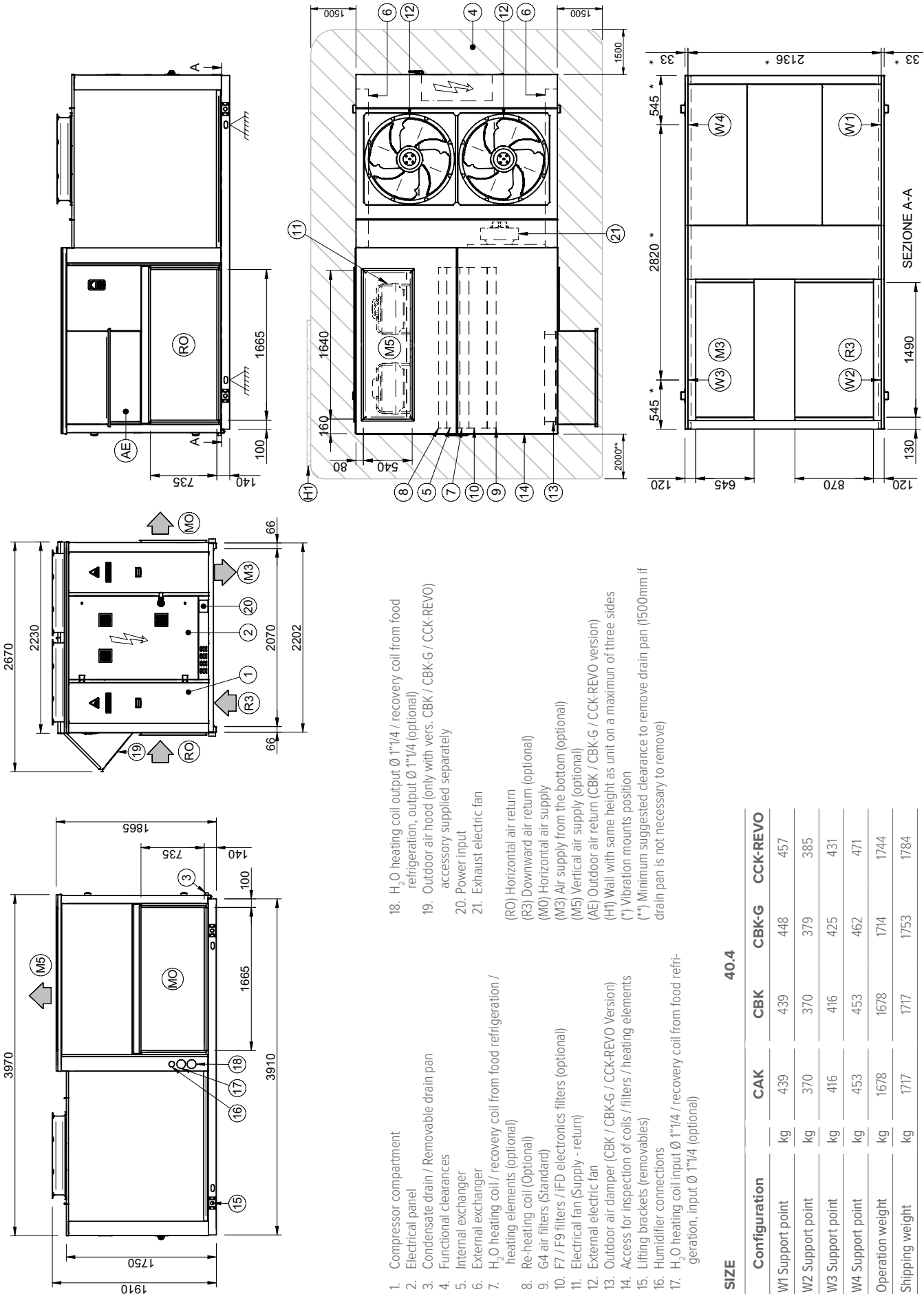

1. Compressor compartment
 2. Electrical panel
 3. Condensate drain / Removable drain pan
 4. Functional clearances
 5. Internal exchanger
 6. External exchanger
 7. H₂O heating coil / recovery coil from food refrigeration / heating elements (optional)
 8. Re-heating coil (Optional)
 9. G4 air filters (Standard)
 10. F7 / F9 filters / iFD electronics filters (optional)
 11. Electrical fan (Supply - return)
 12. External electric fan
 13. Outdoor air damper (CBK / CBK-G / CCK-REVO Version)
 14. Access for inspection of coils / filters / heating elements
 15. Lifting brackets (removables)
 16. Humidifier connections
 17. H₂O heating coil input Ø 1"1/4 / recovery coil from food refrigeration, input Ø 1"1/4 (optional)
 18. H₂O heating coil output Ø 1"1/4 / recovery coil from food refrigeration, output Ø 1"1/4 (optional)
 19. Outdoor air hood (only with vers. CBK / CBK-G / CCK-REVO) accessory supplied separately
 20. Power input
 21. Exhaust electric fan
- (RO) Horizontal air return
(R3) Downward air return (optional)
(M0) Horizontal air supply
(M3) Air supply from the bottom (optional)
(M5) Vertical air supply (optional)
(AE) Outdoor air return (CBK / CBK-G / CCK-REVO version)
(H1) Wall with same height as unit on a maximum of three sides
(*) Vibration mounts position
(**) Minimum suggested clearance to remove drain pan (500mm if drain pan is not necessary to remove)

40.4

Configuration	CAK	CBK	CBK-G	CCK-REVO
W1 Support point	kg 439	439	448	457
W2 Support point	kg 370	370	379	385
W3 Support point	kg 416	416	425	431
W4 Support point	kg 453	453	462	471
Operation weight	kg 1678	1678	1714	1744
Shipping weight	kg 1717	1717	1753	1784

Optional accessories may result in a substantial variation of the weight show in table

Size 40.4 - CAK / CBK / CBK-G / CCK-REVO + GC09X - GC10X - GC11X Version

DAA800003_GC09X-GC10X-GC11X_00
DATA/DATE 07/06/2022

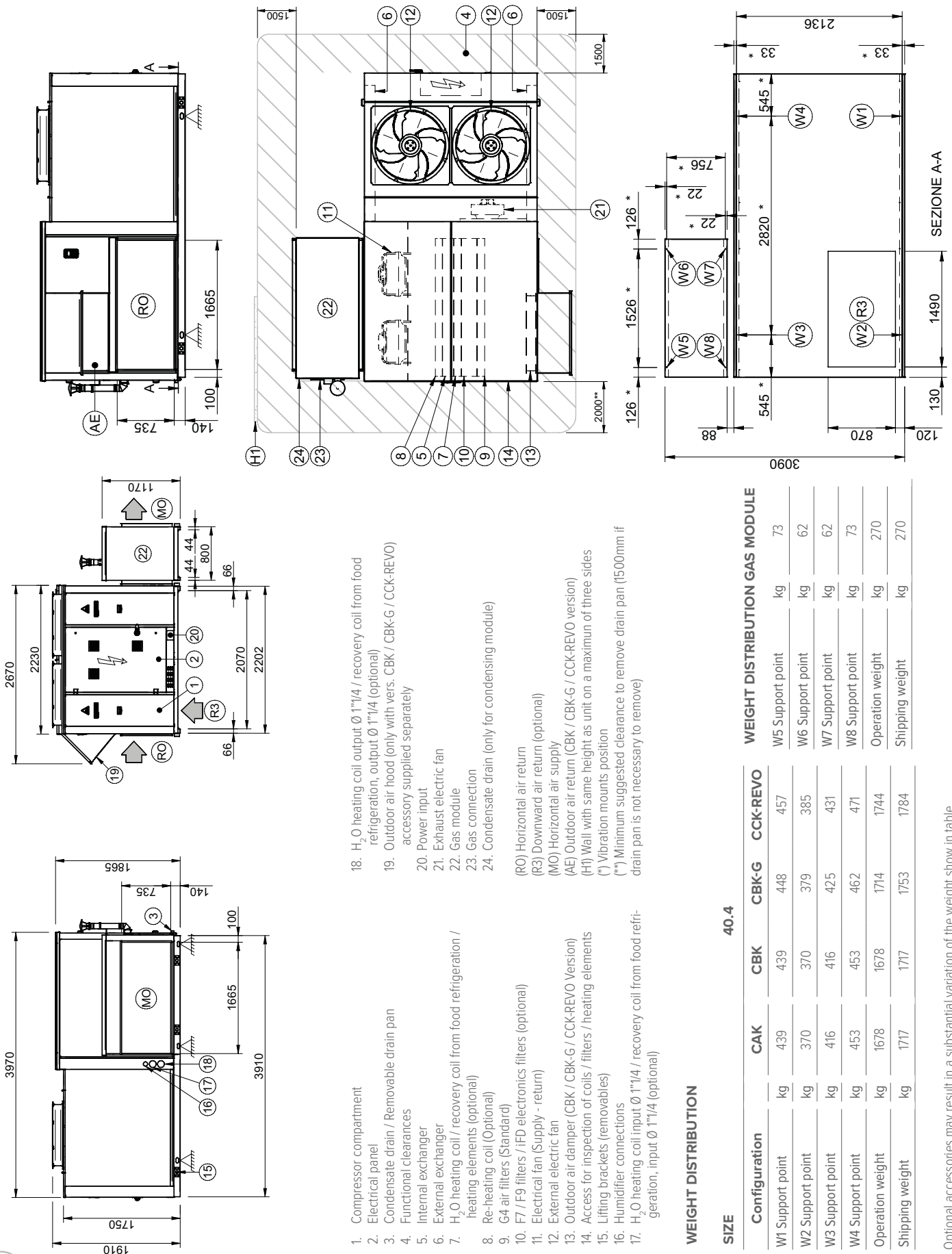

Optional accessories may result in a substantial variation of the weight show in table

Dimensional drawings

Size 40.4 - CAK / CBK / CBK-G / CCK-REVO + GC12X Version

DAA800003_GC12X_00
DATA/DATE 07/06/2022

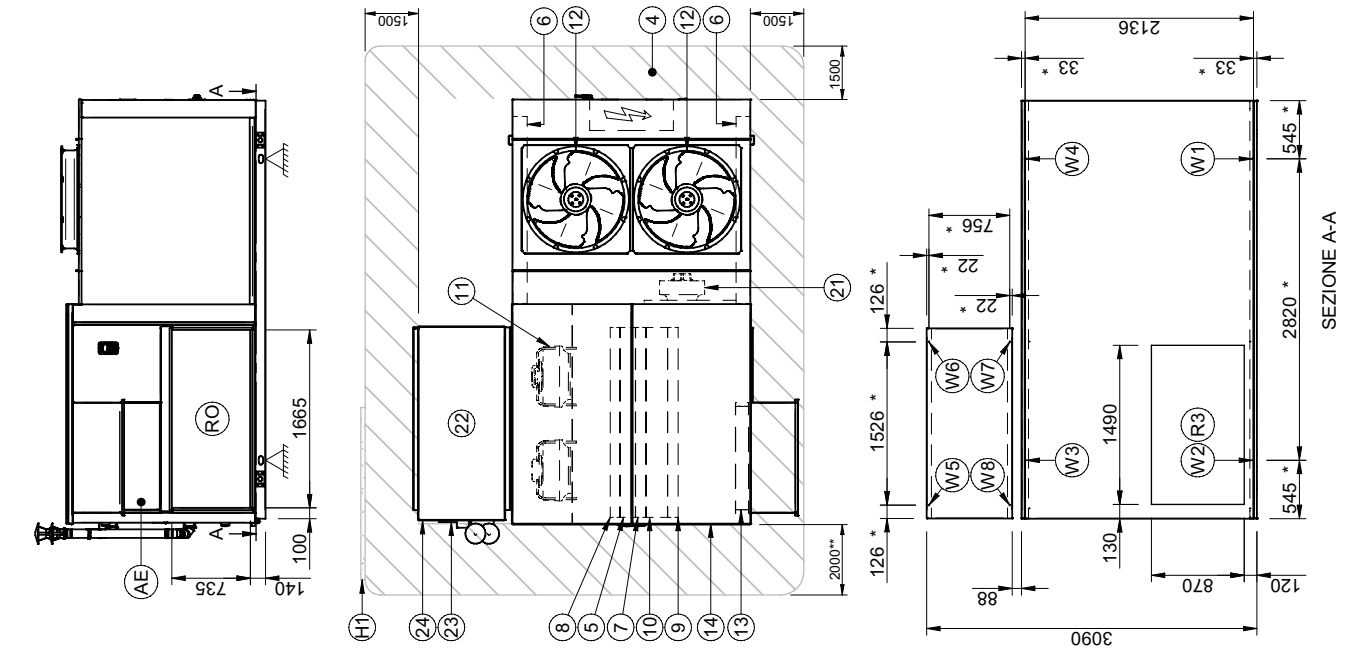

1. Compressor compartment
 2. Electrical panel
 3. Condensate drain / Removable drain pan
 4. Functional clearances
 5. Internal exchanger
 6. External exchanger
 7. H2O heating coil / recovery coil from food refrigeration / heating elements (optional)
 8. Re-heating coil (Optional)
 9. G4 air filters (Standard)
 10. F7 / F9 filters / FD electronics filters (optional)
 11. Electrical fan (Supply - return)
 12. External electric fan
 13. Outdoor air damper (CBK / CBK-G / CCK-REVO Version)
 14. Access for inspection of coils / filters / heating elements
 15. Lifting brackets (removable)
 16. Humidifier connections
 17. H2O heating coil inlet Ø 1"1/4 / food refrig. rec. coil inlet Ø 2" (optional)
 18. H2O heating coil outlet Ø 1"1/4 / food refrig. rec. coil outlet Ø 2" (optional)
 19. Outdoor air hood (only with vers. CBK / CBK-G / CCK-REVO) accessory supplied separately
 20. Power input
 21. Exhaust electric fan
 22. Gas module
 23. Gas connection
 24. Condensate drain (only for condensing module)
- (RO) Horizontal air return
(R3) Downward air return (optional)
(MO) Horizontal air supply
(AE) Outdoor air return (CBK / CBK-G / CCK-REVO version)
(H1) Wall with same height as unit on a maximum of three sides
(**) Minimum suggested clearance to remove drain pan (1500mm if drain pan is not necessary to remove)
(*) Vibration mounts position

WEIGHT DISTRIBUTION

SIZE 40.4

Configuration	CAK	CBK	CBK-G	CCK-REVO	WEIGHT DISTRIBUTION GAS MODULE
W1 Support point	kg 439	kg 439	kg 448	kg 457	W5 Support point kg 90
W2 Support point	kg 370	kg 370	kg 379	kg 385	W6 Support point kg 78
W3 Support point	kg 416	kg 416	kg 425	kg 431	W7 Support point kg 78
W4 Support point	kg 453	kg 453	kg 462	kg 471	W8 Support point kg 90
Operation weight	kg 1678	kg 1678	kg 1714	kg 1744	Operation weight kg 336
Shipping weight	kg 1717	kg 1717	kg 1753	kg 1784	Shipping weight kg 336

Optional accessories may result in a substantial variation of the weight show in table

Size 40.4 - CBK-G Version + Rotary recovery module

DAA800003_RE_00
DATA/DATE 05/08/2022

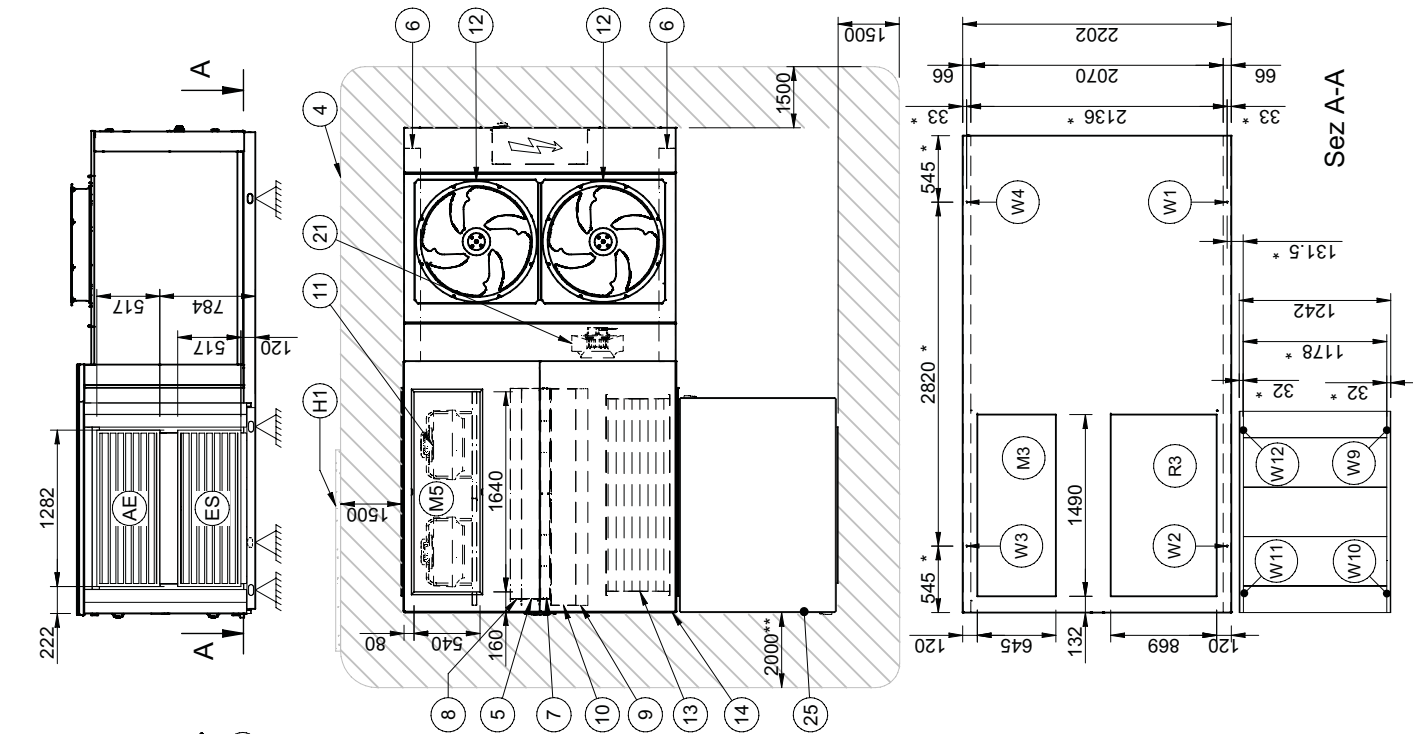

18. H₂O heating coil output Ø 1"1/4 / recovery coil from food refrigeration, output Ø 2" (optional)
19. Power input
20. Rotary recovery module
21. Exhaust electric fan
22. Expulsion damper
23. G4 air filters (espulsione)
24. G4 air filters (outdoor air return)
- (R3) Downward air return (optional)
- (M0) Horizontal air supply
- (M3) Air supply from the bottom (optional)
- (M5) Vertical air supply (optional)
- (AE) Outdoor air return
- (H1) Wall with same height as unit on a maximum of three sides
- (*) Vibration mounts position
- (**) Minimum suggested clearance to remove drain pan (1500mm if drain pan is not necessary to remove)

1. Compressor compartment
2. Electrical panel
3. Condensate drain / Removable drain pan
4. Functional clearances
5. Internal exchanger
6. External exchanger
7. H₂O heating coil / recovery coil from food refrigeration / heating elements (optional)
8. Re-heating coil (Optional)
9. G4 air filters (Standard)
10. F7 / F9 filters / IFD electronics filters (optional)
11. Electrical fan (Supply - return)
12. External electric fan
13. Outdoor air damper / air expulsion
14. Access for inspection of coils / filters / heating elements
15. Lifting brackets (removable)
16. Humidifier connections
17. H₂O heating coil input Ø 1"1/4 / recovery coil from food refrigeration, input Ø 2" (optional)

WEIGHT DISTRIBUTION		WEIGHT DISTRIBUTION ROTARY RECOVERY MODULE	
SIZE	40.4	CBK-G	40.4
Configuration		SIZE	
W1 Support point	kg 448	W5 Support point	kg 173
W2 Support point	kg 379	W6 Support point	kg 162
W3 Support point	kg 425	W7 Support point	kg 141
W4 Support point	kg 462	W8 Support point	kg 154
Operation weight	kg 1714	Operation weight	kg 630
Shipping weight	kg 1753	Shipping weight	kg 645

Optional accessories may result in a substantial variation of the weight show in table

Dimensional drawings

Size 56.4 - CAK / CBK / CBK-G / CCK-REVO Version

DAA80004_00
DATA/DATE 06/06/2022

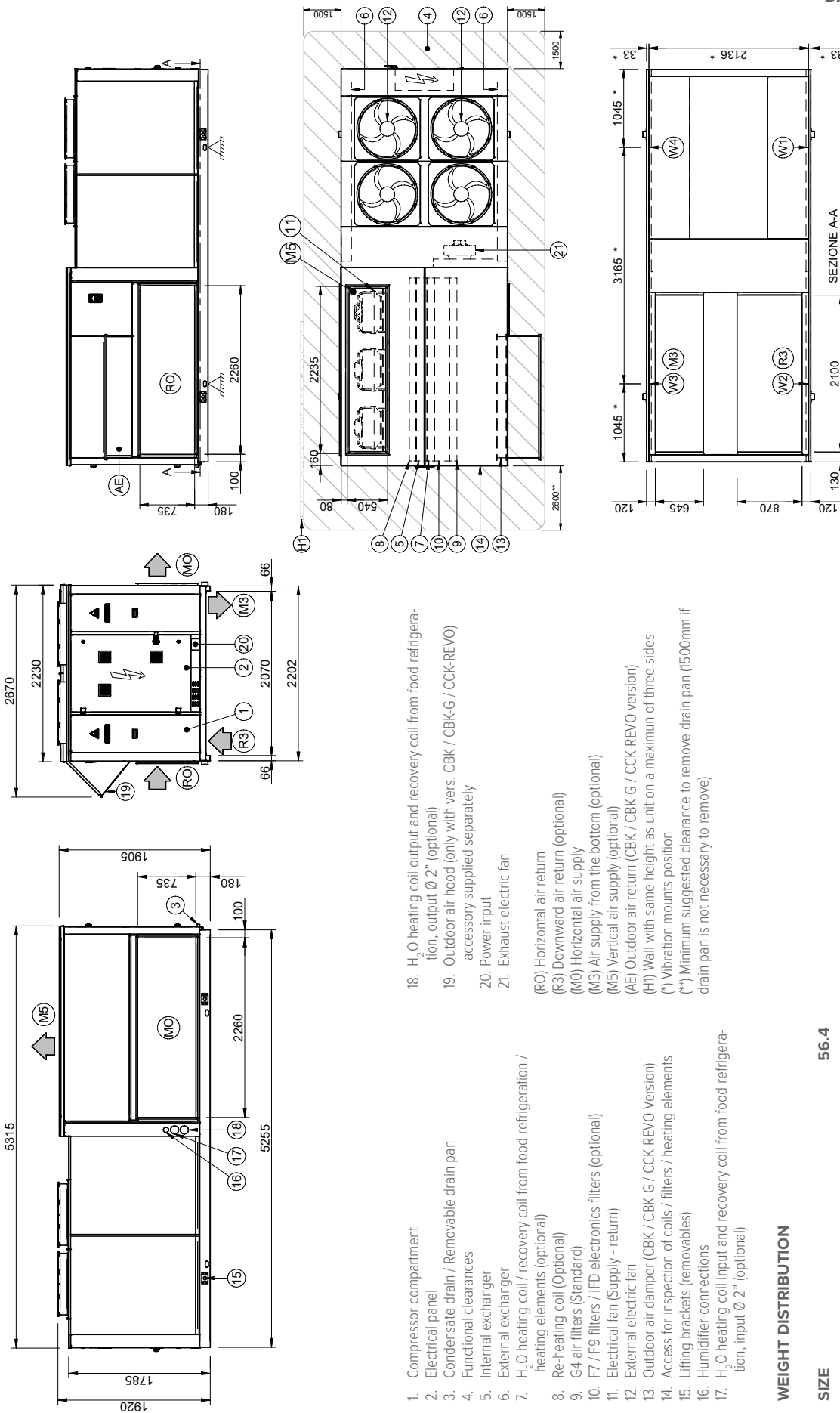

1. Compressor compartment
 2. Electrical panel
 3. Condensate drain / Removable drain pan
 4. Functional clearances
 5. Internal exchanger
 6. External exchanger
 7. H₂O heating coil / recovery coil from food refrigeration / heating elements (optional)
 8. Re-heating coil (Optional)
 9. G4 air filters (Standard)
 10. F7 / F9 filters / IFD electronics filters (optional)
 11. Electrical fan (Supply - return)
 12. External electric fan
 13. Outdoor air damper (CBK / CBK-G / CCK-REVO Version)
 14. Access for inspection of coils / filters / heating elements
 15. Lifting brackets (removable)
 16. Humidifier connections
 17. H₂O heating coil input and recovery coil from food refrigeration, input Ø 2" (optional)
 18. H₂O heating coil output and recovery coil from food refrigeration, output Ø 2" (optional)
 19. Outdoor air hood (only with vers. CBK / CBK-G / CCK-REVO) accessory supplied separately
 20. Power input
 21. Exhaust electric fan
- (RO) Horizontal air return
(R3) Downward air return (optional)
(M0) Horizontal air supply
(M3) Air supply from the bottom (optional)
(M5) Vertical air supply (optional)
(AE) Outdoor air return (CBK / CBK-G / CCK-REVO version)
(H1) Wall with same height as unit on a maximum of three sides
(*) Vibration mounts position
(**) Minimum suggested clearance to remove drain pan (15000mm if drain pan is not necessary to remove)

WEIGHT DISTRIBUTION

56.4

SIZE	Configuration	CAK	CBK	CBK-G	CCK-REVO
W1	Support point	kg 601	601	613	625
W2	Support point	kg 506	506	518	527
W3	Support point	kg 569	569	581	590
W4	Support point	kg 620	620	632	644
	Operation weight	kg 2296	2296	2345	2386
	Shipping weight	kg 2349	2349	2398	2441

Optional accessories may result in a substantial variation of the weight show in table

Size 56.4 - CAK / CBK / CBK-G / CCK-REVO + GC10X - GC11X Version

DAA80004_GC10X-GC11X_00
DATA/DATE 06/06/2022

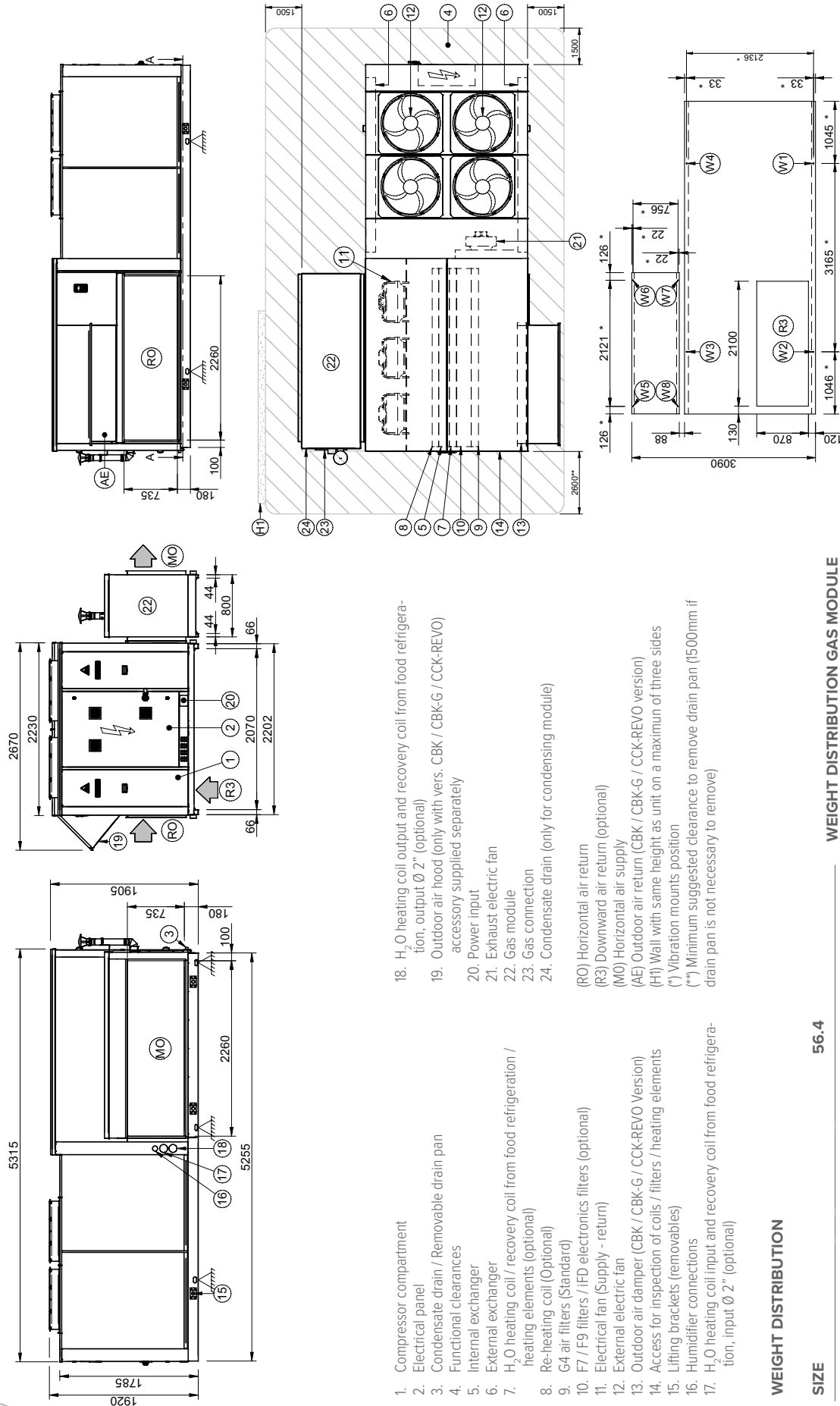

1. Compressor compartment
 2. Electrical panel
 3. Condensate drain / Removable drain pan
 4. Functional clearances
 5. Internal exchanger
 6. External exchanger
 7. H₂O heating coil / recovery coil from food refrigeration / heating elements (optional)
 8. Re-heating coil (Optional)
 9. G4 air filters (Standard)
 10. F7 / F9 filters / FD electronics filters (optional)
 11. Electrical fan (Supply - return)
 12. External electric fan
 13. Outdoor air damper (CBK / CBK-G / CCK-REVO Version)
 14. Access for inspection of coils / filters / heating elements
 15. Lifting brackets (removable)
 16. Humidifier connections
 17. H₂O heating coil input and recovery coil from food refrigeration, input Ø 2" (optional)
 18. H₂O heating coil output and recovery coil from food refrigeration, output Ø 2" (optional)
 19. Outdoor air hood (only with vers. CBK / CBK-G / CCK-REVO) accessory supplied separately
 20. Power input
 21. Exhaust electric fan
 22. Gas module
 23. Gas connection
 24. Condensate drain (only for condensing module)
- (RO) Horizontal air return
(R3) Downward air return (optional)
(MO) Horizontal air supply
(AE) Outdoor air return (CBK / CBK-G / CCK-REVO version)
(H1) Wall with same height as unit on a maximum of three sides
(*) Vibration mounts position
(**) Minimum suggested clearance to remove drain pan (1500mm if drain pan is not necessary to remove)

WEIGHT DISTRIBUTION

SIZE 56.4

Configuration	CAK	CBK	CBK-G	CCK-REVO
W1 Support point	601	601	613	625
W2 Support point	506	506	518	527
W3 Support point	569	569	581	590
W4 Support point	620	620	632	644
Operation weight	2296	2296	2345	2386
Shipping weight	2349	2349	2398	2441

WEIGHT DISTRIBUTION GAS MODULE

W5 Support point	kg	73
W6 Support point	kg	62
W7 Support point	kg	62
W8 Support point	kg	73
Operation weight	kg	270
Shipping weight	kg	270

Optional accessories may result in a substantial variation of the weight show in table

Dimensional drawings

Size 56.4 - CAK / CBK / CBK-G / CCK-REVO + GC12X - GC13X Version

DAA80004_GC12X-GC13
DATA/DATE 06/06/2022

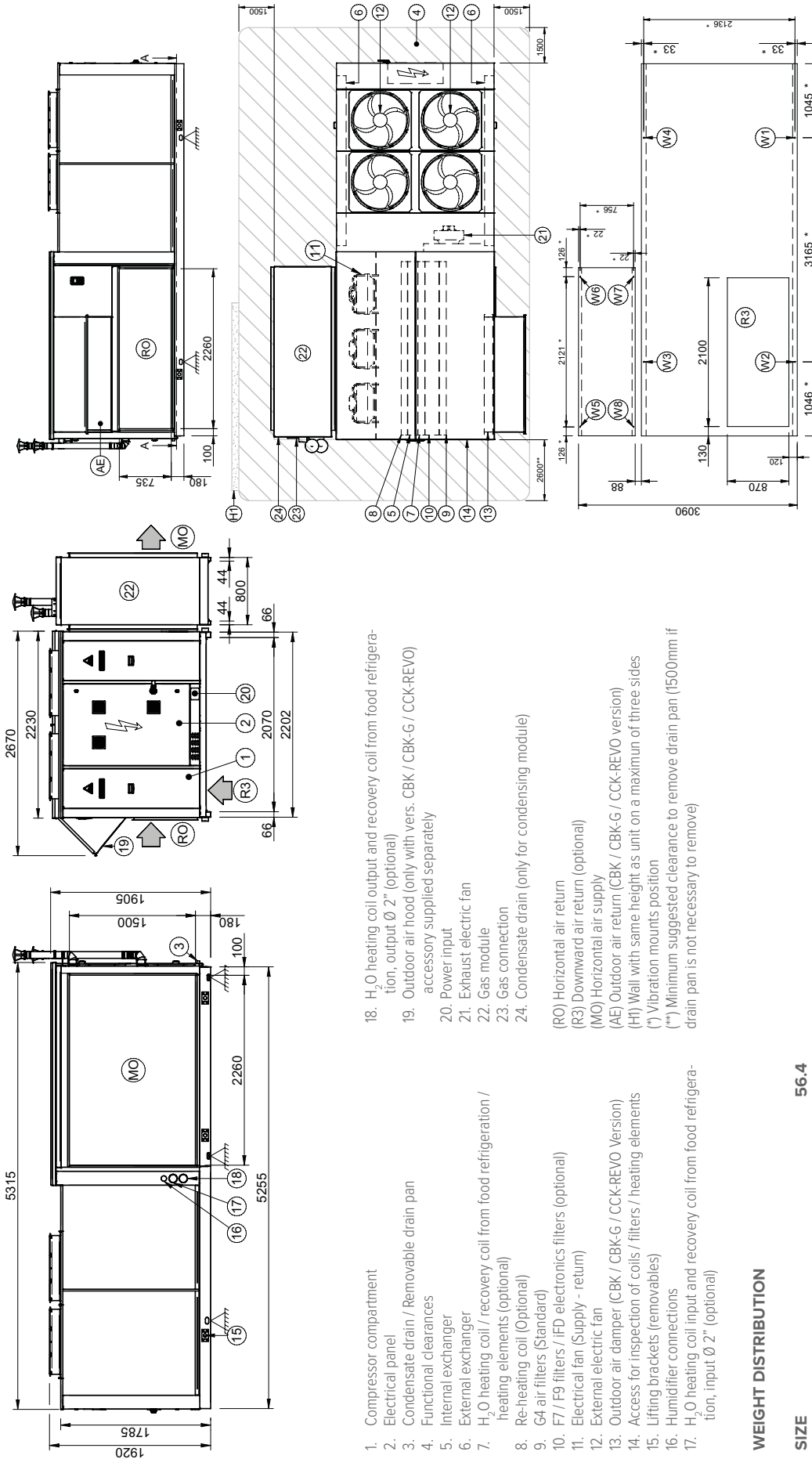

- 1. Compressor compartment
- 2. Electrical panel
- 3. Condensate drain / Removable drain pan
- 4. Functional clearances
- 5. Internal exchanger
- 6. External exchanger
- 7. H₂O heating coil / recovery coil from food refrigeration / heating elements (optional)
- 8. Re-heating coil (Optional)
- 9. G4 air filters (Standard)
- 10. F7 / F9 filters / iFD electronics filters (optional)
- 11. Electrical fan (Supply - return)
- 12. External electric fan
- 13. Outdoor air damper (CBK / CBK-G / CCK-REVO Version)
- 14. Access for inspection of coils / filters / heating elements
- 15. Lifting brackets (removable)
- 16. Humidifier connections
- 17. H₂O heating coil input and recovery coil from food refrigeration, input Ø 2" (optional)
- 18. H₂O heating coil output and recovery coil from food refrigeration, output Ø 2" (optional)
- 19. Outdoor air hood (only with vers. CBK / CBK-G / CCK-REVO accessory supplied separately)
- 20. Power input
- 21. Exhaust electric fan
- 22. Gas module
- 23. Gas connection
- 24. Condensate drain (only for condensing module)

56.4

Configuration	CAK	CBK	CBK-G	CCK-REVO	WEIGHT DISTRIBUTION GAS MODULE
W1 Support point	601	601	613	625	W5 Support point kg 145
W2 Support point	506	506	518	527	W6 Support point kg 100
W3 Support point	569	569	581	590	W7 Support point kg 100
W4 Support point	620	620	632	644	W8 Support point kg 145
Operation weight	2296	2296	2345	2386	Operation weight kg 490
Shipping weight	2349	2349	2398	2441	Shipping weight kg 490

WEIGHT DISTRIBUTION

56.4

Configuration	CAK	CBK	CBK-G	CCK-REVO
W1 Support point	601	601	613	625
W2 Support point	506	506	518	527
W3 Support point	569	569	581	590
W4 Support point	620	620	632	644
Operation weight	2296	2296	2345	2386
Shipping weight	2349	2349	2398	2441

Optional accessories may result in a substantial variation of the weight show in table

Size 56.4 - CBK-G Version + Rotary recovery module

DAA80004_RE_00
DATA/DATE 30/08/2022

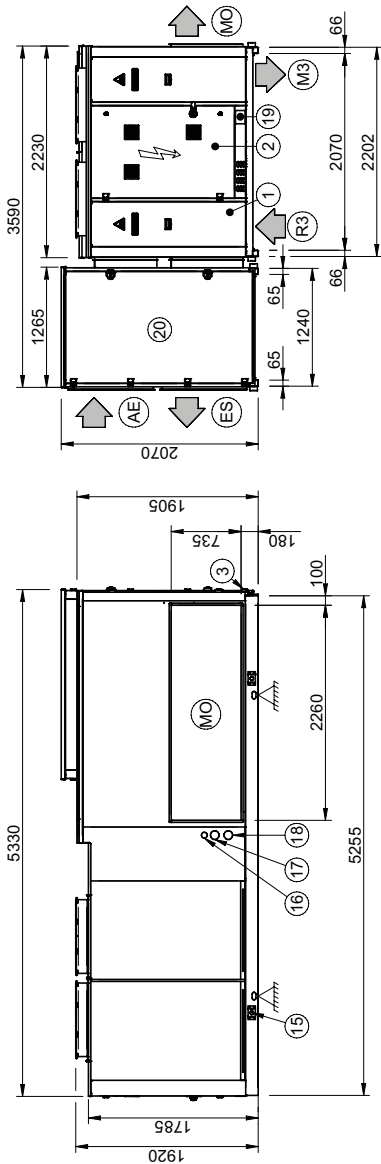
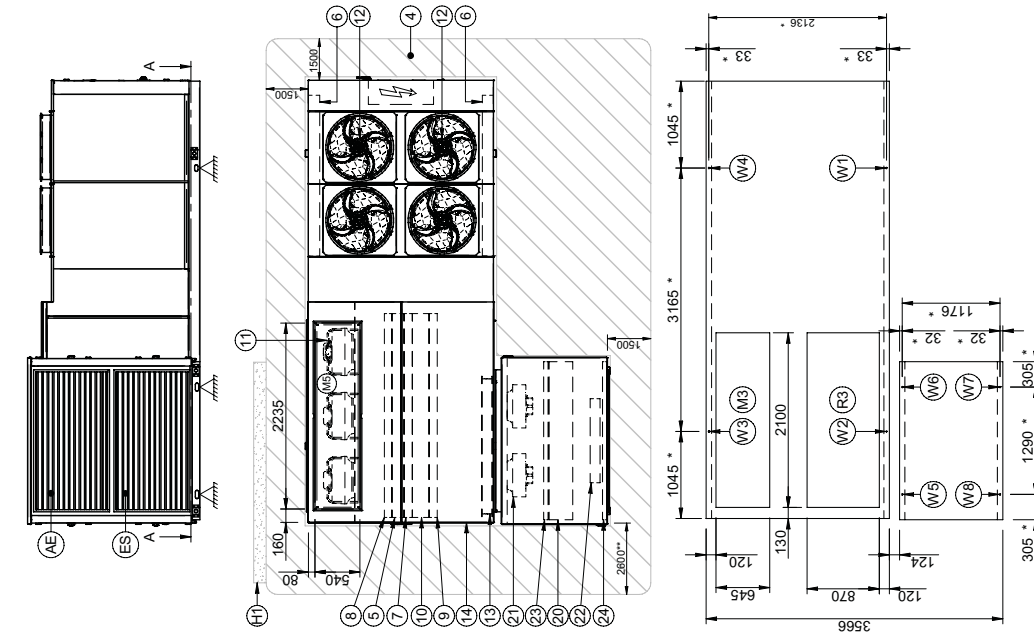

- 18. H₂O heating coil output and recovery coil from food refrigeration, output Ø 2" (optional)
- 19. Power input
- 20. Rotary recovery module
- 21. Exhaust electric fan
- 22. Air expulsion damper
- 23. G4 air filters (espulsione)
- 24. G4 air filters (outdoor air return)

- 1. Compressor compartment
- 2. Electrical panel
- 3. Condensate drain / Removable drain pan
- 4. Functional clearances
- 5. Internal exchanger
- 6. External exchanger
- 7. H₂O heating coil / recovery coil from food refrigeration / re-heating elements (optional)
- 8. Re-heating coil (Optional)
- 9. G4 air filters (Standard)
- 10. F7 / F9 filters / IFD electronics filters (optional)
- 11. Electrical fan (Supply - return)
- 12. External electric fan
- 13. Outdoor air damper / air expulsion
- 14. Access for inspection of coils / filters / heating elements
- 15. Lifting brackets (removable)
- 16. Humidifier connections
- 17. H₂O heating coil input and recovery coil from food refrigeration, input Ø 2" (optional)

WEIGHT DISTRIBUTION

SIZE	56.4	WEIGHT DISTRIBUTION - ROTARY RECOVERY MODULE
Configuration	CBK-G	
W1 Support point	kg	613
W2 Support point	kg	518
W3 Support point	kg	581
W4 Support point	kg	632
Operation weight	kg	2345
Shipping weight	kg	2398
W5 Support point	kg	173
W6 Support point	kg	162
W7 Support point	kg	141
W8 Support point	kg	154
Operation weight	kg	630
Shipping weight	kg	645

Optional accessories may result in a substantial variation of the weight show in table

Page intentionally left blank

FOR OVER 30 YEARS WE HAVE BEEN
OFFERING SOLUTIONS TO ENSURE
SUSTAINABLE COMFORT AND THE WELL-
BEING OF PEOPLE AND THE ENVIRONMENT

www.clivet.com

MideaGroup
Humanizing Technology



sales and service



CLIVET S.p.A.

Via Camp Lonc 25, Z.I. Villapaiera 32032 - Feltre (BL) - Italy
Tel. +39 0439 3131 - info@clivet.it

CLIVET GMBH

Hummelsbütteler Steindamm 84,
22851 Norderstedt, Germany
Tel. +49 40 325957-0 - info.de@clivet.com

Clivet Group UK LTD

Units F5 & F6 Railway Triangle,
Portsmouth, Hampshire PO6 1TG
Tel. +44 02392 381235 -
Enquiries@Clivetgroup.co.uk

CLIVET LLC

Office 508-511, Elektrozavodskaya st. 24,
Moscow, Russian Federation, 107023
Tel. +7495 6462009 - info.ru@clivet.com

CLIVET MIDEAST FZCO

Dubai Silicon Oasis (DSO) Headquarter Building,
Office EG-05, P.O Box-342009, Dubai, UAE
Tel. +9714 3208499 - info@clivet.ae

Clivet South East Europe

Jarušćica 9b
10000, Zagreb, Croatia
Tel. +3851 222 8784 - info.see@clivet.com

CLIVET France

10, rue du Fort de Saint Cyr - 78180 Montigny le
Bretonneux, France
info.fr@clivet.com

Clivet Airconditioning Systems Pvt Ltd

Office No.501 & 502,5th Floor, Commercial -I,
Kohinoor City, Old Premier Compound, Off LBS
Marg, Kiroi Road, Kurla West, Mumbai
Maharashtra 400070, India
Tel. +91 22 30930200 - sales.india@clivet.com

CLIVETPack3i - CSRN-IY 20.2-56.4 - BT221001GB-00