



*Air source inverter
free-cooling, liquid chiller
for outdoor installation*

Large EVO FC

WiSAT-YEE1 FC 45.4-90.4 RANGE



TECHNICAL BULLETIN



SIZE	45.4	50.4	55.4	60.4	65.4	70.4	75.4	80.4	85.4	90.4
COOLING CAPACITY [KW]	104	113	129	143	158	173	186	201	214	232

Page

3	Features and benefits
5	Standard unit technical specifications
7	Unit configuration
8	Built-in options
9	Accessories separately supplied
10	General technical data
18	Performances
24	Configurations
26	Accessories - Hydronic assembly
42	Features and options
46	Dimensional drawings



Clivet participates in the ECP Programme for “Liquid Chillers and Hydronic Heat Pumps”.
Check ongoing validity of certificate on www.eurovent-certification.com”

Features and benefits

LARGE EVO is the new generation of air cooled liquid chillers and heat pumps, equipped with Full DC Inverter technology and R-32 refrigerant with low environmental impact, designed for outdoor installation.

WiSAT-YEE1 FC

Air-cooled chiller with Free-cooling chiller, Full DC Inverter technology and refrigerant R-32

- Range 104 ÷ 232 kW
- Excellence / Premium Version
- Seasonal efficiency (SEER) 4,84
- Operating with 48°C of outdoor air temperature
- Operating with -25°C of outdoor air temperature
- Full aluminium microchannel coils
- Copper aluminium free-cooling coil
- Partial recovery of the condensing heat
- Plate exchanger
- 2 refrigeration circuits



WiSAT-YEE1

Air cooled reversible heat pump with full DC inverter technology and R-32 refrigerant

- Range 110 ÷ 252 kW
- Excellence / Premium Version
- Seasonal efficiency (SEER) 5.16/4.90
- Operating with 48°C of outdoor air temperature
- Operating with -20°C of outdoor air temperature
- Full aluminium microchannel coils
- Partial recovery of the condensing heat
- Plate exchanger
- 2 refrigeration circuits



WiSAN-YEE1

Air cooled reversible heat pump with full DC inverter technology and R-32 refrigerant

- Range 115 ÷ 233 kW
- Seasonal efficiency (SCOP) up to 4,22
- Seasonal efficiency (SEER) up to 4.51
- Operating with 48°C of outdoor air temperature in cooling
- Operating with 48°C of outdoor air temperature in cooling
- Hot water production up to 60°C
- Copper/aluminum condensing coil
- Partial recovery of the condensing heat
- Plate exchanger
- 2 refrigeration circuits



The Large EVO range in free-cooling version is available in the range from 104 kW up to 232 kW in two different energy versions: EXCELLENCE (EXC) with high performance both in operation as a traditional chiller and in Free Cooling operation. PREMIUM (PRM) most effective solution in terms of first investment..

Energy Efficiency

SEER up to 4,94 which makes it extremely competitive
Capacity modulation from 20% to 100%.

Extensive operating limits

Outdoor temperature	max	min
Cooling	48°C	-25°C
Outlet water temperature	max	min
Cooling	20°C	-8°C

Functionality

- Climatic compensation with external temperature
- Double set-point management
- EVU lock ready (remote on/off)
- Demand limit

Acoustic configuration

Two sound configurations levels:

- Standard acoustic configuration
- Super-silenced acoustic configuration (-6 dB(A))

Application versatility

All the main system components are supplied on the unit, ensuring maximum manufacturing reliability and easy installation:

- Hydropack with 1 inverter pump, low or high head
- Hydropack with 1 on/off pump, low or high head
- Hydropack with 2 inverter pumps in duty/stand-by configuration, low or high head
- Hydropack with 2 on/off pumps in duty/stand-by configuration, low or high head
- System storage tank
- Partial energy recovery

Cascade management

LARGE EVO is designed to connect up to 8 units in a local network, reaching a maximum unit capacity of 1856 kW.

Direct Free-cooling

For systems using glycol as antifreeze.

In the Excellence version, an optimization of the section dedicated to free-cooling allows the nominal capacity to be obtained with compressors off up to 2.1 °C external air temperature.

In the Premium version, the section dedicated to free-cooling allows allows the nominal capacity to be obtained with compressors off up to 1.1 °C external air temperature.

Standard unit technical specifications

Compressor

Size 45.4 - 55.4

Inverter-controlled rotary hermetic compressor fitted with a motor protection device for overheating, overcurrents and excessive temperatures of the supply gas. It is installed on rubber anti-vibration mounts and comes with a full oil charge. The compressor is wrapped in a sound-absorbing hood, that reduces its sound emissions. A crankcase heater with automatic activation prevents the refrigerant from diluting the oil when the compressor stops.

Size 60.4 - 90.4

Inverter-controlled hermetic Scroll compressor with steam injection fitted with a motor protection device for overheating, overcurrents and excessive temperatures of the supply gas. It is installed on rubber antivibration mounts and comes with a full oil charge. The compressor has a sound blanket, that reduces its sound emissions and thermally insulates it.

Structure

Supporting structure and base made entirely of sturdy sheet steel, 12/10 thick, with hot-dip galvanised surface treatment and parts in full view painted with polyester powder RAL9001, which guarantees excellent mechanical characteristics and high corrosion resistance over time.

Panelling

External panelling made of sheet steel, 12/10 thick, with hot-dip galvanised surface treatment and painted with polyester powder RAL9001 that guarantees greater corrosion resistance in outdoor installations and eliminates the need for periodic painting. The panels can be easily removed to fully access internal components.

Internal exchanger

Direct expansion heat exchanger, braze-welded AISI 316 stainless steel plates, in pack without seals using copper as the brazing material, with low refrigerant charge and large exchange surface, complete with:

- 17 mm thick external no-condensation thermal insulation in sintered expanded polypropylene;
- antifreeze heater to protect the water side exchanger, preventing the formation of frost if the water temperature falls below a set value.

External exchanger

Full aluminium microchannel coil. The entire exchanger (tubes, fins and manifolds) is made of aluminum and welded into a single body through a special brazing technology in a controlled-temperature chamber. The fins have a special corrugated surface to ensure maximum heat exchange efficiency. The special flat configuration of the pipes reduces the section that opposes to the air flow, limiting the pressure drops and maximizing the surface. The total refrigerant charge into the microchannel coil is reduced by 40% compared to an equivalent copper coil.

Direct FREE-COOLING

Finned coil free-cooling water-air exchanger made from copper pipes arranged in staggered rows and mechanically expanded to better adhere to the fin collar. Unique direct free-cooling components: three-way valve with on/off control. Configuration that allows considerable savings on system management costs in applications that require chilled water even during the cold season, such as industrial processes, data centres, telecommunications, technological applications and shopping centres. The free-cooling coil must be protected from freezing, typically by adding a suitable antifreeze such as ethylene glycol. The percentage of glycol in the solution depends on the minimum temperature value in the installation area, and is therefore included in the basic parameters of the system design.

Fan

Axial fans with sickle-shaped blades made of ABS ASG-20 resin reinforced with 20% glass fibre, directly coupled to the electronically controlled motor (IP23), driven by the continuous magnetic switching of the stator. The brushless technology and the special power supply increase both the lifecycle and the efficiency. Consumption is thus reduced by as much as 50%. The fans are housed in aerodynamically shaped nozzles to increase efficiency and minimise noise levels and are fitted with accident prevention grilles. Both fans and grilles are designed with CFD technology. Supplied with variable speed control.

Refrigeration circuit

Two independent refrigeration circuits made of copper, brazed and factory-assembled, complete with:

- electronic expansion valve;
- safety high pressure switch;
- low pressure safety switch;
- oil separator;
- suction separator;
- high pressure transducer;
- safety thermostat against compressor drain overheating;
- temperature sensors;
- low pressure safety valve.

Size 60.4 - 90.4

- economizer exchanger

Electrical panel

The power section includes:

- main disconnecting switch;
- general protection fuses;
- insulation transformer for powering the auxiliary circuit;
- auxiliary component protection fuses;
- AC filter on power supply
- power supply phase sequence protection;
- protection for compressor over current;
- protection for compressor overload;
- sensor malfunction protection;
- phase monitor.

The control section includes:

- compressor overload protection and timer;
- relay for remote cumulative fault signal;
- condenser control;
- dry contact for remote on-off control;

The control keypad includes:

- interface terminal with graphic display;
- multifunction keys for ON/OFF control;
- alarms display and reset;
- daily or weekly schedule;
- power output for remote control;
- serial port with Modbus outlet (RS 485) for remote communication.

Water circuit

- temperature sensors;
- drain valve;
- antifreeze heaters to protect the water side exchanger to prevent ice from forming if the water temperature drops below the pre-set value;
- differential pressure switch, water side;
- relief valve.

Test

Unit subjected to factory-tested in specific steps and test pressure of the piping of the refrigerant circuit (with nitrogen and hydrogen), before shipping them.

Unit equipment with outdoor air low temperatures

MINIMA TEMPERATURA ARIA ESTERNA		UNITÀ IN FUNZIONAMENTO		UNITÀ IN MANTENIMENTO ⁽⁵⁾ (fed unit)	UNITÀ IN STOCCAGGIO (unit not fed)
		FREDDO*			
+11°C	1		✓ STANDARD UNIT	✓ STANDARD UNIT ⁽⁶⁾	
+2°C	2				
-5°C	4				
-7°C	3				
-10 °C	4				
From -10°C to -20°C		✓ STANDARD UNIT			
From -20°C to -25°C			✓ WATER EMPTY UNIT OR WITH AN APPROPRIATE GLYCOL PERCENTAGE APPROPRIATE		
From -25°C to -30°C		NOT POSSIBLE	✗ NOT SUITABLE: BUILT-IN PUMPS	NOT POSSIBLE	

Data referred to the following conditions:

*chilled water production:

cold side exchanger water = 12/7°C

1. Part load unit and air speed equal to 1 m/s.
2. Part load unit and air speed equal to 0.5 m/s.
3. Part load unit and outdoor air temperature at rest.
4. Full load unit and outdoor air temperature at rest.

⁽⁵⁾ The water pumping unit must be fed and connected to the unit according to the manual.

⁽⁶⁾ Unit without water or containing water with an appropriate quantity of glycol.

At the unit start-up the water temperature or water with glycol must be inside the operating range indicated in the "Operating range" graph.

To know the water freezing temperature on varying the glycol percentage refer to the specific 'Correction factors for glycol use' table.

⚠ Air conditions which are at rest are defined as the absence of air flowing towards the unit. Weak winds can induce air to flow through the exchanger and air-levels which can cause a reduction in the operating range.

In the presence of predominant winds it is necessary to use suitable windbreak barriers.

⚠ The unit, with an outdoor air temperature on average lower than -10°C, can remain stored for a maximum of 1 month.

Unit configuration

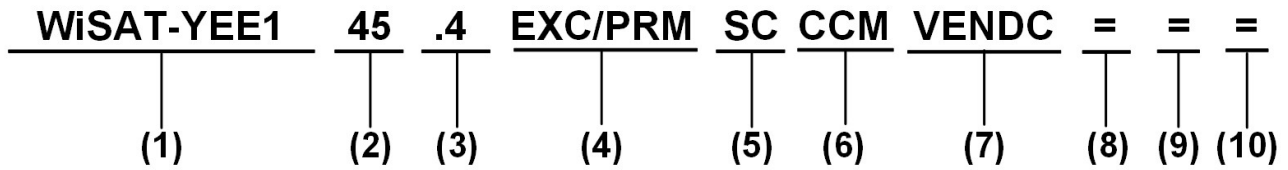

(1) Range

WiSAT = Air-cooled liquid chiller with inverter compressors

(2) Size

45 = Nominal compressor capacity (HP)

(3) Compressors

.4 = Compressor quantity

(4) FREE COOLING Version

EXC = EXCELLENCE Version (standard)

PRM = PREMIUM Version

(5) Acoustic configuration

SC = Acoustic configuration with compressor soundproofing (standard)

EN = Super-silenced acoustic configuration

(6) Condensing coil

CCM = Aluminum microchannel condensing coils (Standard)

CCME = E-coated microchannel coil

(7) Fan

VENDC = DC high efficiency fans (standard)

(8) Hydronic unit on the user side

(-) Not required (standard)

1PM = Hydropack with N° 1 pump

1PMH = Hydropack with N° 1 high static pressure pump

1PMV = Hydropack with N° 1 inverter pump

1PMVH = Hydropack with N° 1 high static pressure inverter pump

1P1SB = Hydropack with N° 1 pump + N° 1 in stand-by

1PAP+S = Hydropack with N° 1 high static pressure pump + N° 1 in stand-by pump

1P1SBV = Hydropack with N° 1 inverter pump and N° 1 stand-by pump with dedicated inverter

1PAPSV = Hydropack with 1 high head inverter pump and 1 stand-by pump with dedicated inverter

(9) Storage tank

(-) Not required (standard)

ACC = Storage tank

(10) Energy recovery

(-) Not required (standard)

D = Partial energy recovery

ACC	Storage tank <p>Steel storage tank complete with double layer covering with closed-cell insulation, stainless steel anti-freeze immersion resistance, bleed valve, draw off cock, cast-iron shut-off butterfly valve with quick connections and activation lever with a mechanical calibration lock at the evaporator output, quick connections with insulated casing.</p> <p>The water tank capacity is 300 litres for sizes 45.4 to 55.4.</p> <p>The water tank capacity is 500 litres for sizes 60.4 to 90.4.</p> <p>The device is installed and wired on the unit and is located on the system's return line.</p>
CMSC13	Serial communication module ModBus TCP/IP, BACnet/IP, BACnet MS/TP <p>This enables the serial connection of the supervision system, using ModBus TCP/IP, BACnet/IP, BACnet MS/TP as the communication protocol. It enables access to the complete list of operational variables, commands and alarms. Using this accessory every unit can dialogue with the main supervision systems.</p> <p>The device is installed and wired on the unit.</p> <p>⚠ The configuration and management activities for the BACnet networks are the responsibility of the client.</p> <p>⚠ The total length of each individual serial line must not exceed 1000 m and the line must be connected in bus type (input/output).</p>
CCME	E-coated microchannel coil <p>The full aluminium microchannel coil is completely treated by electrolysis so as to create a protective layer of epoxy polymer on the surface, with the following characteristics:</p> <ul style="list-style-type: none">• over 3000 hours of protection against salt spray (ASTM G85 A3 - SWAAT);• over 2000 hours of protection against UV rays (ASTM G155-05a) <p>provide a very high resistance against corrosion.</p>
PGFC	Finned coil protection grilles <p>The grilles protect the external coil from accidental contact with objects or persons. Ideal for installation in places where persons can pass from, such as car parks, terraces, etc.</p>
PGCCH	Anti-hail protection grilles <p>Grille made of electro-welded and painted drawn steel suitable for protecting the external coil from hail damage.</p> <p>Accessories supplied and installed on the unit.</p>
RPR	Refrigerant leak detector <p>The leak detector device, in-built on the unit and positioned inside the compressor compartment, detects leaks from the internal refrigeration circuit.</p>
REMAU	Additional board for advanced functions management <p>Multifunction board installed in the electrical panel of the unit for the advanced functions management.</p> <p>The available digital contacts allow the following remote functions:</p> <ul style="list-style-type: none">• remote on/off• Double set-point management• EVUlock function• Demand limit• Activation of silent or super-silent acoustic version (selectable on the user interface) <p>The additional board does not allow the simultaneous use of digital inputs and Modbus signal.</p>
ABU	Water connections flush with the unit are required <p>The water connections of the unit in standard configuration (without hydronic groups installed on board, or accumulation tank or DHW switching valve), end at the plate heat exchanger.</p> <p>It is necessary to select this option if water connections flush with the unit are required.</p> <p>If hydronic groups or buffer tank or DHW switching valve are selected, the ABU option is automatically selected.</p>

Accessories separately supplied

IFWX

Steel mesh strainer on the water side

The device prevents any impurity in the hydraulic circuit from soiling the exchanger. The stainless steel mesh mechanical filter must be placed on the water inlet line. It needs to be easy to remove for periodical maintenance and cleaning operations. The Victaulic filter water connections are 2" 1/2 for sizes 45.4 to 55.4 and 3" for sizes 60.4 to 90.4.

Filter pressure drop

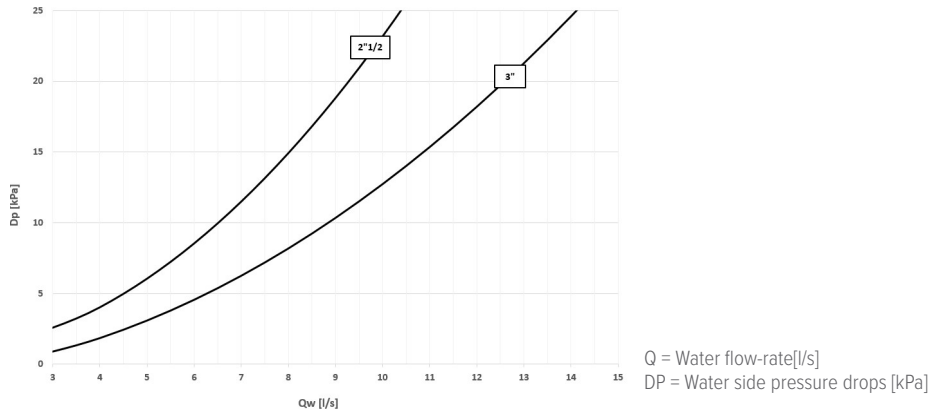

AVIBX

Anti-vibration mount support

The rubber antivibration mounts are attached in special housing on the support frame and serve to smooth the vibrations produced by the unit, thus reducing the noise transmitted to the support structure.

AMMSX

Anti-seismic spring antivibration mounts

The anti-seismic spring antivibration mounts must be fastened in special housings on the supporting metal struts. The containment structure is designed to ensure high resistance multidirectional forces acting on the surface of the unit in the presence of wind and / or telluric movements. The antivibration mounts have been tested according to ANSI/ASHRAE standard 171-2008 (Method of Testing Seismic Restraint devices for HVAC&R Equipment). The performance levels and test methodology have been validated and certified by Lloyd's Register.

⚠ Installation is a responsibility of the Customer.

PGFCX

Finned coil protection grilles

The grilles protect the external coil from accidental contact with objects or persons. Ideal for installation in places where persons can pass from, such as car parks, terraces, etc.

PGCCHX

Anti-hail protection grilles

Grille made of electro-welded and painted drawn steel suitable for protecting the external coil from hail damage.

IOTX

IoT industrial module for cloud based interoperability & services

This device allows the monitoring and the remote control the unit via Clivet Eye, the supervision cloud system for Clivet units.

With IoT module (i-LINK) it will be possible to monitor and manage the unit through the mobile app Clivet Eye and the dedicated web page.

Among the main functions, for all monitored units they allow to:

- display the main working parameters;
- display the alarms;
- switch on/off the unit;
- change the setpoint;
- change the operating mode;
- set the daily/weekly start-up or power-off programming of the unit;
- create charts of main system parameters trend (via web interface);
- display in a map the units monitored by Clivet Eye (via web interface).

Web interface at www.cliveteye.com.

Clivet Eye app available in Google Play and Apple Store

- ⚠ IoT module to be provided for each unit to be remotely monitored.
- ⚠ Internet ethernet connection in charge of customer.
- ⚠ Clivet Eye management is alternative to an external BMS supervision system.
- ⚠ Installation is a responsibility of the Customer.



Performance - EXC e PRM Version

Acoustic configuration with compressor soundproofing (SC)

Size			45.4	50.4	55.4	60.4	65.4	70.4	75.4	80.4	85.4	90.4
Cooling												
Cooling capacity	1	[kW]	104	113	129	143	158	173	186	201	215	232
Compressor power input	1	[kW]	30,3	34,8	42,7	38,3	45,4	53,0	52,7	58,6	64,7	74,1
Total power input	2	[kW]	33,9	38,5	46,3	43,8	50,8	58,5	58,1	64,1	70,1	79,6
Partial recovery heating capacity	3	[kW]	31,5	34,7	40,3	42,6	47,7	53,1	56,1	61,0	65,6	71,8
EER	1	-	3,07	2,95	2,78	3,27	3,11	2,96	3,21	3,14	3,06	2,91
Water flow-rate (User Side)	1	[l/s]	4,97	5,41	6,15	6,84	7,55	8,28	8,91	9,61	10,3	11,1
Internal exchanger pressure drop	1	[kPa]	16,6	19,4	24,5	16,3	19,6	23,2	26,6	30,6	34,5	39,7
Cooling capacity (EN14511:2022)	4	[kW]	104	113	129	143	158	173	186	201	214	232
Total power input (EN14511:2022)	4	[kW]	34,1	38,7	46,7	44,0	51,2	58,9	58,7	64,7	70,9	80,5
EER (EN14511:2022)	4	-	3,05	2,92	2,75	3,25	3,08	2,94	3,17	3,10	3,02	2,88
SEER	6	-	4,72	4,71	4,71	4,94	4,93	4,88	4,93	4,91	4,83	4,81
SEPR	7	-	6,01	5,99	5,90	6,18	6,15	6,10	6,17	6,14	6,04	6,01
Cooling capacity (AHRI 550/590)	5	[kW]	104	113	129	143	158	173	186	201	215	232
Total power input (AHRI 550/590)	5	[kW]	33,9	38,5	46,3	43,8	50,8	58,5	58,1	64,1	70,1	79,6
COPR	5	-	3,07	2,95	2,78	3,27	3,11	2,96	3,21	3,14	3,06	2,91
IPLV	5	-	4,59	4,58	4,61	4,86	4,85	4,78	4,83	4,84	4,74	4,71

Super-silenced acoustic configuration (EN)

Size			45.4	50.4	55.4	60.4	65.4	70.4	75.4	80.4	85.4	90.4
Cooling												
Cooling capacity	1	[kW]	92,6	101	114	124	141	154	170	179	191	206
Compressor power input	1	[kW]	27,6	31,8	38,9	31,5	38,4	48,2	49,9	54,5	60,1	67,4
Total power input	2	[kW]	30,6	34,7	41,9	35,9	42,8	52,6	54,4	59,0	64,5	71,8
Partial recovery heating capacity	3	[kW]	28,2	31,1	36,0	36,5	42,0	47,5	51,7	54,8	59,0	64,2
EER	1	-	3,03	2,90	2,74	3,45	3,29	2,93	3,13	3,04	2,96	2,87
Water flow-rate (User Side)	1	[l/s]	4,42	4,82	5,47	5,92	6,73	7,37	8,14	8,55	9,13	9,85
Internal exchanger pressure drop	1	[kPa]	13,4	15,7	19,8	12,5	15,9	18,8	22,5	24,7	27,8	32,0
Cooling capacity (EN14511:2022)	4	[kW]	92,5	101	114	124	141	154	170	179	191	206
Total power input (EN14511:2022)	4	[kW]	30,7	34,9	42,1	36,1	43,1	52,9	54,8	59,4	65,1	72,5
EER (EN14511:2022)	4	-	3,01	2,88	2,71	3,43	3,26	2,91	3,10	3,01	2,93	2,84
SEER	6	-	4,69	4,68	4,67	4,92	4,90	4,84	4,89	4,87	4,78	4,77
SEPR	7	-	5,96	5,94	5,82	6,15	6,13	6,05	6,12	6,09	5,97	5,96
Cooling capacity (AHRI 550/590)	5	[kW]	92,6	101	114	124	141	154	170	179	191	206
Total power input (AHRI 550/590)	5	[kW]	30,6	34,7	41,9	35,9	42,8	52,6	54,4	59,0	64,5	71,8
COPR	5	-	3,03	2,90	2,74	3,45	3,29	2,93	3,13	3,04	2,96	2,87
IPLV	5	-	4,44	4,43	4,44	4,70	4,69	4,60	4,65	4,66	4,55	4,54

II The Product complies with the European ErP Directive (Energy Related Products), which includes the Commission Regulation (EU) 2016/2281, also known as Ecodesign LOT21. Contains fluorinated greenhouse gases (GWP 675)

1. Data referring to the following conditions: Water temperature to the internal exchanger = 12/7 °C. Temperature of air entering the external exchanger = 35°C. Evaporator fouling factor = $0.44 \times 10^{(-4)}$ m² K/W
2. The Total Power Input value does not take into account the part related to the pumps and required to overcome the pressure drops for the circulation of the solution inside the exchangers.
3. Recovery exchanger water = 40/45°C
4. Data compliant to Standard EN 14511:2022 referred to the following conditions: internal exchanger water temperature = 12/7 °C. Entering external exchanger air temperature = 35°C
5. Data calculated in accordance with AHRI 550/590 under the following conditions: Water temperature to the internal exchanger = 6.7 °C. Water flow-rate 0.043 l/s per kW. Temperature of air entering the external exchanger = 35°C. Evaporator fouling factor = $0.18 \times 10^{(-4)}$ m² K/W
6. Data calculated in compliance with EN 14825:2018.
7. Data compliant according to EU regulation 2016/2281

General technical data

Construction - EXC and PRM Version

Size		45.4	50.4	55.4	60.4	65.4	70.4	75.4	80.4	85.4	90.4	
Compressor												
Type of compressors	1	ROTARY INVERTER				SCROLL INVERTER						
Refrigerant							R-32					
N° compressors	[Nr]	4	4	4	4	4	4	4	4	4	4	
Rated power (C1)	[HP]	25	25	25	35	35	35	45	45	45	45	
Rated power (C2)	[HP]	25	25	25	35	35	35	45	45	45	45	
Std Capacity control steps		STEPLESS										
Oil charge (C1)	[l]	4,6	4,6	4,6	6,2	6,2	6,2	7,2	7,2	7,2	7,2	
Oil charge (C2)	[l]	4,6	4,6	4,6	6,2	6,2	6,2	7,2	7,2	7,2	7,2	
Refrigerant charge (C1)	[Kg]	6,5	6,5	6,5	9,5	9,5	9,5	10,0	10,0	10,0	10,0	
Refrigerant charge (C2)	[Kg]	6,5	6,5	6,5	9,5	9,5	9,5	10,0	10,0	10,0	10,0	
Refrigeration circuits	[Nr]	2	2	2	2	2	2	2	2	2	2	
Internal exchanger												
Type of internal exchanger	2	PHE										
N. of internal exchanger	[Nr]	1	1	1	1	1	1	1	1	1	1	
Water content (EXC)	[l]	75,8	75,8	75,8	110,0	110,0	110,0	110,0	110,0	110,0	110,0	
Water content (PRM)	[l]	68,8	68,8	68,8	96,8	96,8	96,8	96,8	96,8	96,8	96,8	
Minimum system water content	[l]	880	970	1090	1220	1350	1480	1590	1710	1830	1980	
External exchanger												
Type of external exchanger	3	CCM										
Number of coils	[Nr]	2	2	2	2	2	2	2	2	2	2	
External Section Fans												
Type of fans	4	AX										
Number of fans	[Nr]	2	2	2	3	3	3	3	3	3	3	
Type of motor	5	BRUSHLESS DC										
Standard airflow (SC)	[l/s]	14500	14500	14500	21750	21750	21750	21750	21750	21750	21750	
Standard airflow (EN)	[l/s]	12567	12567	12567	18850	18850	18850	18850	18850	18850	18850	
Connections												
Water fittings		2"1/2	2"1/2	2"1/2	3"	3"	3"	3"	3"	3"	3"	
Power supply												
Standard power supply		400/3/50										
Electrical data												
F.L.A. - Total	[A]	110	112	115	168	170	175	200	205	211	216	
F.L.I. - Total	[kW]	69,9	71,0	73,2	75,3	76,4	78,7	99,5	102,0	105	107	
M.I.C. - Value	6 [A]	59	59	59	89	89	89	111	111	111	111	

1. PHE = Plate exchanger
2. CCM = Aluminum microchannel condensing coils
3. AX = Axial fan
4. M.I.C.=Maximum unit starting current. The M.I.C. value is obtained adding the max. compressor starting current of the highest size to the power input at max. admissible conditions (F.L.A.) of the remaining electric components.

Voltage unbalance between phases: max 2 %

Voltage variation: max +/- 10%

Electrical data refer to standard units; according to the installed accessories, the data can suffer some variations.

Sound level

Acoustic configuration with compressor soundproofing (SC)

SIZE	Sound Power Level								Sound Pressure Level dB(A)	Sound Power Level dB(A)
	Octave band (Hz)									
	63	125	250	500	1000	2000	4000	8000		
45.4	78	74	73	76	80	80	71	71	66	84
50.4	78	74	73	76	80	80	71	71	66	84
55.4	78	74	73	76	80	80	71	71	66	84
60.4	83	79	76	79	83	81	73	73	68	87
65.4	83	79	76	79	83	81	73	73	68	87
70.4	84	80	77	80	84	82	74	74	69	88
75.4	86	82	83	81	84	84	76	76	70	89
80.4	86	82	83	81	84	84	76	76	70	89
85.4	86	82	83	81	84	84	76	76	70	89
90.4	86	82	83	81	84	84	76	76	70	89

Super-silenced acoustic configuration (EN)

SIZE	Sound Power Level								Sound Pressure Level dB(A)	Sound Power Level dB(A)
	Octave band (Hz)									
	63	125	250	500	1000	2000	4000	8000		
45.4	74	69	68	70	76	71	67	66	60	78
50.4	74	69	68	70	76	71	67	66	60	78
55.4	74	69	68	70	76	71	67	66	60	78
60.4	65	65	69	73	79	74	68	70	62	81
65.4	65	65	69	73	79	74	68	70	62	81
70.4	66	66	70	74	80	75	69	71	63	82
75.4	80	83	76	77	80	76	72	73	65	84
80.4	80	83	76	77	80	76	72	73	65	84
85.4	80	83	76	77	80	76	72	73	65	84
90.4	80	83	76	77	80	76	72	73	65	84

Sound levels refer to full load units, in test nominal conditions. The sound pressure level refers to 1 m. from the standard unit outer surface operating in open field. Measures according to UNI EN ISO 9614-2 regulations, with respect to the EUROVENT 8/1 certification, which provides for a tolerance of 3 dB(A).

Data referred to the following conditions:

- cold side exchanger water temperature = 12/7 °C

Entering external exchanger air temperature = 35°C

General technical data

Operating range - Cooling

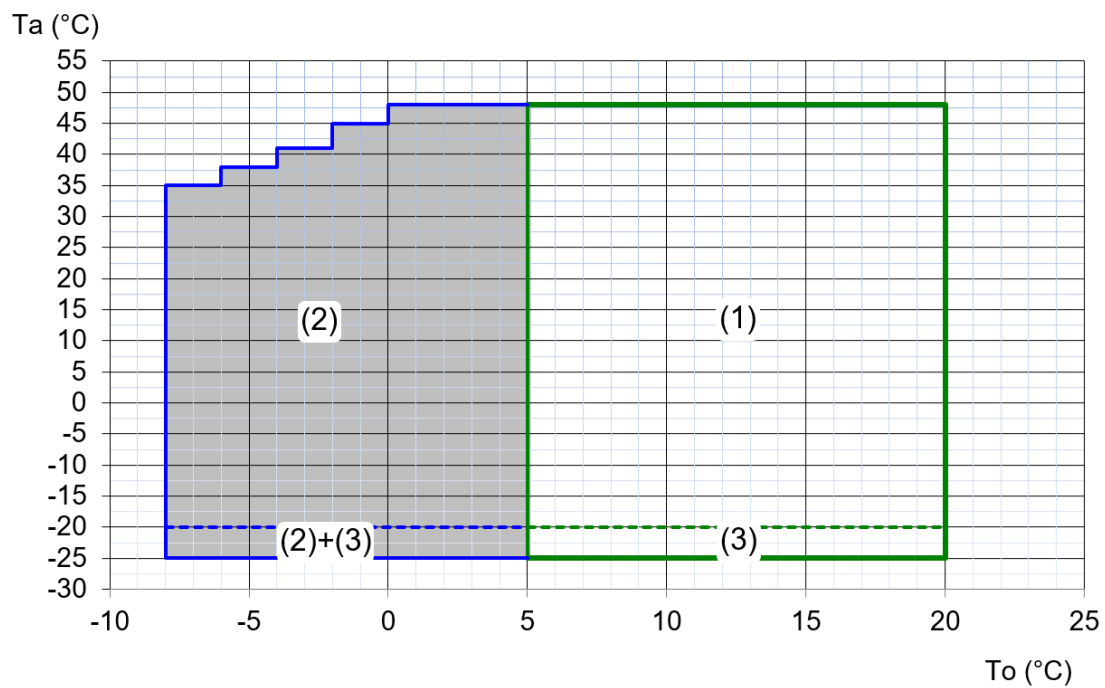

1. Standard unit operating range
2. Operating range where the use of glycol is mandatory in relation to the temperature of the outlet water from the user side exchanger
3. Unit operating range as given in the "Unit equipment with outdoor air low temperatures" table

FCD - Direct FREE-COOLING

Configuration that allows for considerable savings on the system's running costs in applications that require chilled water also during the cold season, such as industrial processes, data centres, telecommunications, technological applications and shopping centres. When the outdoor air temperature is lower than the temperature of the system's return water, the FREE-COOLING system recovers cold from the external environment and reduces the operation of the compressors until they stop completely. The higher the temperature of the chilled water in the system (e.g. 10-15°C instead of 7-12°C), the greater the operating range of the FREE-COOLING system and, therefore, the higher the energy savings.

Use of anti-freeze solutions

The FREE-COOLING configuration is particularly indicated in buildings where, at least in certain periods of the year, the temperature of the outdoor air also reaches very low values. For this reason the liquid must be protected from the risk of freezing, typically using the addition of a suitable anti-freeze substance such as ethylene glycol. The percentage of glycol in the solution depends on the minimum temperature value foreseen in the installation zone, and is in any case within the fundamental parameters of the plan for the system.

Management logic

There are three main operating modes, which basically differ in terms of position of the three-way switching valve and the number of active compressors.

(A) Summer

In the summer season, with outdoor air temperatures which are greater than the return temperature of the liquid in the system, the three-way valve is switched in such a way as to exclude the FREE-COOLING coils. The cooling of the liquid is referred to the direct expansion circuit, with the intervention of the compressors as in a traditional chiller.

(B) Intermediate season

In the winter season, or rather with the outdoor air temperature at a little below the return water temperature of the system, when the unit identifies that the temperature conditions are favourable:

- switches the position of the three-way valve, forcing the solution to transit through the FREE-COOLING coils before reaching the evaporator;
- brings the fans to maximum speed to make the most of the cooling of the solution carried out by the outdoor air
- conducts a first cooling of the solution in a 'natural way and free of charge';
- provides any missing capacity via the cooling circuit using compressors with partial operation (power input proportional to the partialisation level).

If the outdoor air temperature should increase, the microprocessor automatically converts the operating mode to the summer mode, guaranteeing the conditions requested by the user at all times.

(C) Winter

In the winter season, with the outdoor air temperature below the return water temperature of the system, the unit identifies that the temperature conditions are favourable for operating in FREE-COOLING mode:

- the 3-way valve is switched like in the previous case, forcing the solution to transit through the FREE-COOLING coils before reaching the evaporator;
- the outdoor air temperature brings the solution at the outlet of the FREE-COOLING coils already at the temperature required by the utility;
- the microprocessor control completely deactivates all the compressors which supply all the requested cooling capacity at no cost, in contrast to traditional chillers.

The difference between the outdoor air temperature and that requested for use could also be such as to lower the temperature of the solution at the output of the FREE-COOLING coils to below the set-point requested for use. This is a condition which does not prejudice the safety of the unit thanks to the presence of anti-freeze in the solution. The microprocessor modulates fan speed up to the point where they are switched off. If, with all the fans switched, off the temperature continues to decrease, the three-way valve positions itself automatically in the summer operational mode, thus enabling the requested set-point to be maintained.

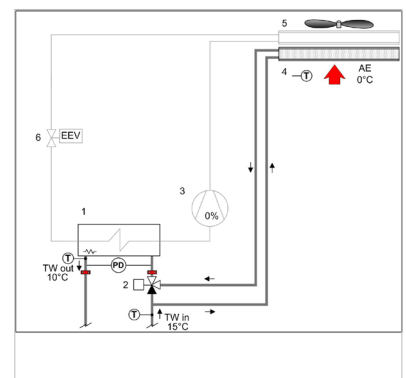
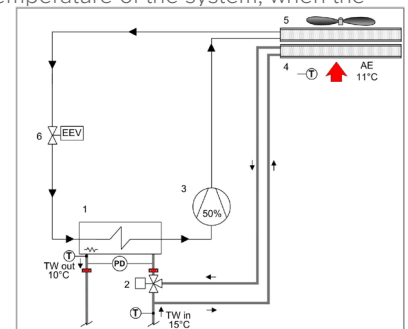
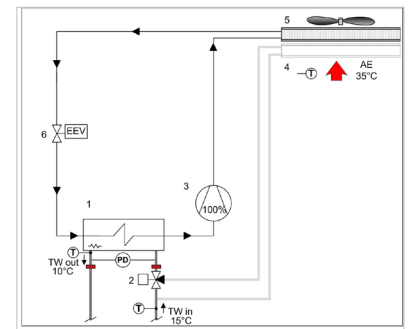

- 1 - Internal exchanger
- 2 - Three-way valve for FREE-COOLING
- 3 - Compressors
- 4 - External exchanger
- 5 - External fan
- 6 - Expansion electronic valve
- T - Temperature probe
- TW in chilled water inlet
- TW out chilled water outlet
- AE - Outdoor air
- PD - Differential pressure switch

General technical data

Acoustic configuration with compressor soundproofing (SC)

Determination of the direct free-cooling percentage - EXC version

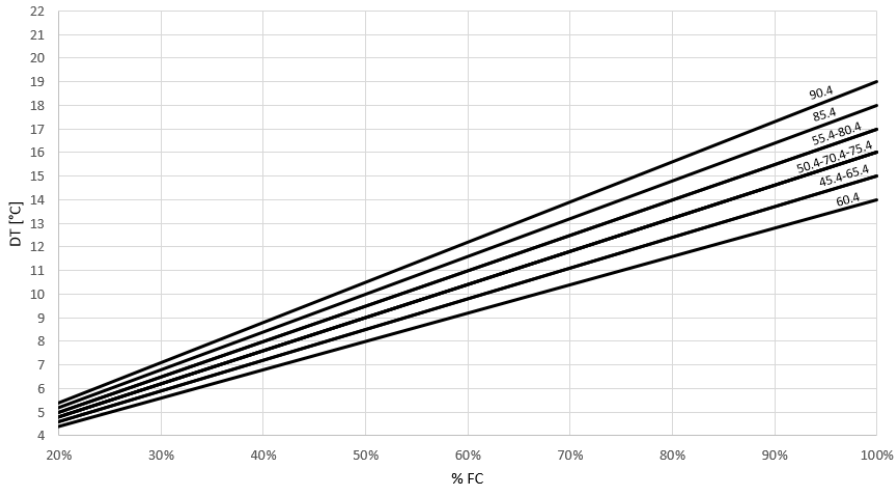

Determination of the direct free-cooling percentage - PRM version

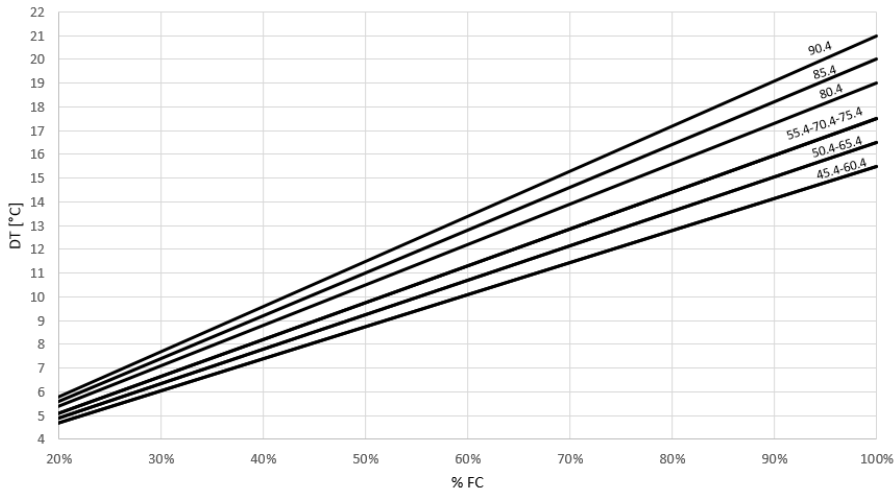

DT [°C] = Temperature difference between the system return water and the outdoor air
 % FC = FREE-COOLING percentage (compared to the Nominal FREE-COOLING capacity)

EXC Version

SIZE		45.4	50.4	55.4	60.4	65.4	70.4	75.4	80.4	85.4	90.4
Nominal FREE-COOLING capacity	kW	112	124	139	151	165	183	198	210	227	244
Air temperature with FREE-COOLING at 100%	°C	1,20	0,40	-0,60	2,10	1,40	0,50	-0,20	-0,80	-1,70	-2,50

PRM version (considering same capacity)

SIZE		45.4	50.4	55.4	60.4	65.4	70.4	75.4	80.4	85.4	90.4
Nominal FREE-COOLING capacity	kW	112	124	139	151	165	183	198	210	227	244
Air temperature with FREE-COOLING at 50%	°C	0,60	-0,20	-1,40	1,10	0,20	-0,90	-1,80	-2,60	-3,50	-4,70

PRM version (considering the same ZET)

SIZE		45.4	50.4	55.4	60.4	65.4	70.4	75.4	80.4	85.4	90.4
FREE-COOLING capacity	kW	97,7	108	121	133	146	160	172	179	195	209
Air temperature with FREE-COOLING at 100%	°C	1,20	0,40	-0,60	2,10	1,40	0,50	-0,20	-0,80	-1,70	-2,50

Super-silenced acoustic configuration (EN)

Determination of the direct free-cooling percentage - EXC version

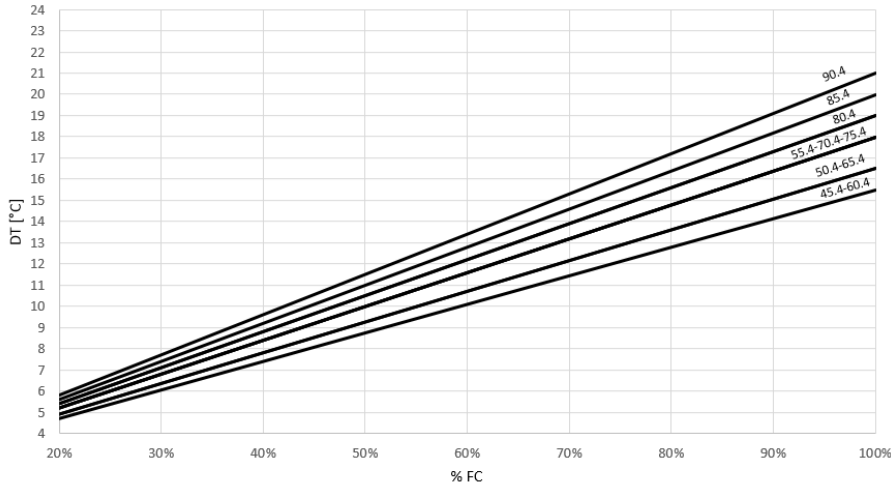

DT [°C] = Temperature difference between the system return water and the outdoor air

% FC = FREE-COOLING percentage (compared to the Nominal FREE-COOLING capacity)

Determination of the direct free-cooling percentage - PRM version

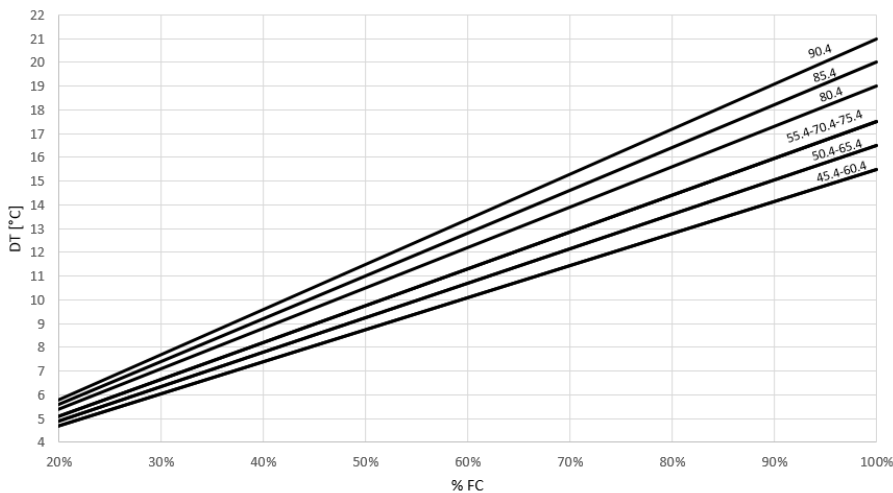

DT [°C] = Temperature difference between the system return water and the outdoor air

% FC = FREE-COOLING percentage (compared to the Nominal FREE-COOLING capacity)

EXC Version

SIZE		45.4	50.4	55.4	60.4	65.4	70.4	75.4	80.4	85.4	90.4
Nominal FREE-COOLING capacity	kW	100	110	124	133	148	163	176	187	202	217
Air temperature with FREE-COOLING at 100%	°C	-0,50	-1,50	-2,90	0,90	-0,20	-1,20	-2,10	-2,90	-3,90	-5,00

Versione PRM (a parità di potenza smaltita)

SIZE		45.4	50.4	55.4	60.4	65.4	70.4	75.4	80.4	85.4	90.4
Nominal FREE-COOLING capacity	kW	100	110	124	133	148	163	176	187	202	217
Air temperature with FREE-COOLING at 50%	°C	-1,00	-1,90	-3,20	-0,10	-1,30	-2,20	-3,40	-4,30	-5,50	-6,70

Versione PRM (a parità di ZET)

SIZE		45.4	50.4	55.4	60.4	65.4	70.4	75.4	80.4	85.4	90.4
FREE-COOLING capacity	kW	90,8	99	109	124	135	146	160	168	181	195
Air temperature with FREE-COOLING at 100%	°C	-0,50	-1,50	-2,90	0,90	-0,20	-1,20	-2,10	-2,90	-3,90	-5,00

General technical data

Correction factors for ethylene glycol use

% ETHYLENE GLYCOL BY WEIGHT		5%	10%	15%	20%	25%	30%	35%	40%	45%	50%
Freezing temperature	°C	-2	-3,9	-6,5	-8,9	-11,8	-15,6	-19	-23,4	-27,8	-32,7
Safety temperature	°C	3	1	-1	-4	-6	-10	-14	-19	-23,8	-29,4
Cooling Capacity Factor	Nr	0,997	0,994	0,990	0,986	0,981	0,976	0,970	0,964	0,957	0,950
Compressor power input Factor	Nr	0,999	0,999	0,998	0,997	0,996	0,996	0,995	0,994	0,993	0,993
Internal exchanger pressure drop factor	Nr	1,016	1,035	1,056	1,080	1,106	1,135	1,166	1,200	1,236	1,275

Correction factors for propylene glycol use

% PROPYLENE GLYCOL BY WEIGHT		5%	10%	15%	20%	25%	30%	35%	40%	45%	50%
Freezing temperature	°C	-2	-3,9	-6,5	-8,9	-11,8	-15,6	-19	-23,4	-27,8	-32,7
Safety temperature	°C	3	1	-1	-4	-6	-10	-14	-19	-23,8	-29,4
Cooling Capacity Factor	Nr	0,995	0,99	0,983	0,976	0,968	0,96	0,95	0,939	0,928	0,916
Compressor power input Factor	Nr	0,999	0,997	0,995	0,993	0,991	0,988	0,986	0,983	0,98	0,977
Internal exchanger pressure drop factor	Nr	1,027	1,058	1,093	1,133	1,176	1,224	1,276	1,332	1,393	1,457

Fouling Correction Factors

SCAMBIATORE INTERNO (EVAPORATORE)

M ² C/W	F1	FK1
0,44x10 (-4)	1	1
0,88x10 (-4)	0,97	0,99
1,76x10 (-4)	0,94	0,98

F1 = Cooling capacity correction factors

FK1 = Compressor power input correction factor

Exchanger operating range

SCAMBIATORE INTERNO

		DPR	DPW
Plate exchanger	PED (CE)	4500	1000

DPr = Maximum operating pressure on refrigerant side in kPa

DPw = Maximum operating pressure on water side in kPa

Overload and control device calibrations

		APERTO	CHIUSO	VALORE
Refrigerant side				
High pressure safety pressure switch	kPa	4200	3200	-
Low pressure safety pressure switch	kPa	140	300	-
Gas-liquid separator safety valve	kPa	-	-	3000
Safety thermostat against compressor drain overheating	°C	75	115	-
Water side				
Antifreeze protection	°C	8	4	-
High pressure safety valve	kPa	-	-	1000

Cooling - Acoustic configuration with compressor soundproofing (SC)

SIZE	To (°C)	Entering external exchanger air temperature (°C)											
		25		30		35		40		45		48	
		kWf	kWe_tot	kWf	kWe_tot	kWf	kWe_tot	kWf	kWe_tot	kWf	kWe_tot	kWf	kWe_tot
45.4	5	98,6	27,6	94,6	29,2	88,8	33,2	75,9	33,3	56,5	30,2	45,6	26,2
	6	103	27,6	98,6	29,3	96,4	33,5	79,2	33,5	58,7	30,4	47,2	26,4
	7	107	27,6	103	29,3	104	33,9	82,5	33,7	60,9	30,6	48,9	26,5
	10	113	27,6	115	30,4	105	34,0	87,1	33,9	64,7	30,9	52,2	26,8
	15	131	27,5	126	30,6	119	34,5	102	34,4	75,6	31,6	60,7	27,3
	18	143	27,4	138	30,6	131	34,6	112	34,6	82,4	32,0	66,0	27,5
	20	152	27,3	147	30,7	138	34,6	118	34,7	87,0	32,1	69,6	27,6
50.4	5	109	30,5	103	32,8	97,9	37,4	82,9	36,5	62,1	32,3	51,3	29,3
	6	113	30,5	108	32,9	106	37,9	86,4	36,7	64,6	32,5	53,2	29,5
	7	117	30,6	112	32,9	113	38,5	90,0	37,0	67,1	32,7	55,1	29,7
	10	125	30,6	127	34,2	118	38,0	95,2	37,2	71,2	33,0	58,7	30,0
	15	144	30,6	138	34,5	131	38,5	111	37,9	83,4	33,8	68,5	30,7
	18	158	30,5	151	34,5	144	38,7	122	38,1	91,0	34,1	74,5	31,0
	20	167	30,4	160	34,5	152	38,7	129	38,2	96,1	34,3	78,6	31,1
55.4	5	123	33,3	118	37,3	110	44,8	92,8	39,2	68,1	31,7	55,4	29,2
	6	127	33,4	122	37,4	119	45,6	96,8	39,5	71,0	31,9	57,7	29,4
	7	132	33,5	127	37,6	129	46,3	101	39,7	73,9	32,1	59,9	29,6
	10	142	33,7	142	39,5	129	46,2	107	40,1	78,1	32,3	63,6	29,9
	15	161	33,9	154	39,8	146	46,2	124	40,9	91,9	33,0	74,5	30,6
	18	177	34,1	168	40,1	160	46,2	136	41,3	101	33,2	81,3	30,9
	20	187	34,1	178	40,3	169	46,5	145	41,5	107	33,4	85,9	31,1
60.4	5	137	35,3	132	37,9	127	43,0	108	42,7	80,6	38,5	66,2	36,9
	6	142	35,4	137	38,1	135	43,4	112	42,9	83,3	38,7	67,1	37,0
	7	147	35,6	141	38,2	143	43,8	116	43,1	86,0	38,8	68,0	37,1
	10	154	35,9	155	38,3	147	44,1	122	43,4	91,2	39,1	75,3	37,5
	15	176	36,5	170	39,2	164	44,4	141	44,0	106	39,8	88,0	38,2
	18	192	36,8	185	39,5	179	44,6	154	44,2	116	39,9	96,6	38,4
	20	202	36,9	196	39,6	189	44,7	163	44,2	123	39,9	103	38,4
65.4	5	149	41,6	143	42,4	137	50,6	119	50,3	87,4	44,3	72,2	43,5
	6	154	41,8	148	42,6	148	50,7	123	50,5	90,4	44,5	74,6	43,7
	7	159	42,0	153	42,8	158	50,8	127	50,7	93,3	44,7	77,0	43,9
	10	167	42,3	169	42,7	161	51,4	134	51,0	98,9	45,0	82,1	44,3
	15	191	43,1	184	44,3	184	52,2	155	51,8	115	45,7	95,9	45,1
	18	208	43,5	201	44,7	200	52,5	169	52,0	126	45,8	105	45,4
	20	219	43,7	212	44,8	212	52,6	179	52,0	134	45,8	112	45,5
70.4	5	172	50,1	165	50,7	164	58,1	136	56,0	101	49,8	82,4	45,9
	6	178	50,4	171	50,8	168	58,3	141	56,3	104	50,1	85,1	46,1
	7	184	50,6	177	50,9	173	58,5	146	56,5	108	50,3	87,9	46,3
	10	194	51,1	188	51,1	184	60,4	153	56,8	114	50,6	93,5	46,7
	15	220	52,3	213	52,7	207	61,5	177	57,6	132	51,4	109	47,4
	18	240	53,0	231	53,3	225	62,1	193	57,8	145	51,6	120	47,6
	20	253	53,4	244	53,6	239	62,3	204	57,8	154	51,6	127	47,5
75.4	5	177	44,8	171	48,9	164	57,2	141	56,5	108	52,0	86,3	45,8
	6	184	45,1	177	49,2	175	57,7	146	56,9	111	52,4	88,9	46,1
	7	190	45,3	183	49,4	186	58,1	151	57,3	115	52,8	91,5	46,4
	10	200	45,7	203	50,9	191	58,4	158	57,9	120	53,5	96,5	47,0
	15	227	46,6	219	52,0	210	58,9	181	60,1	137	55,7	110	48,8
	18	245	47,2	237	52,5	228	60,0	195	61,7	147	57,3	118	50,1
	20	258	47,7	249	52,8	240	60,8	205	62,8	154	58,5	123	51,1
80.4	5	192	53,4	185	53,0	178	63,8	155	68,6	117	65,7	92,7	56,0
	6	199	53,6	192	53,2	190	63,9	161	69,0	120	66,2	95,4	56,3
	7	206	53,8	198	53,5	201	64,1	166	69,5	124	66,7	98,2	56,6
	10	217	54,1	215	55,8	205	65,0	173	70,2	130	67,6	104	57,3
	15	246	54,9	237	54,9	228	66,5	198	72,6	148	70,5	118	59,3
	18	265	55,4	256	55,6	247	67,5	214	74,3	159	72,6	127	60,7
	20	279	55,8	269	56,1	259	68,3	224	75,6	166	74,1	132	61,8
85.4	5	207	59,8	199	61,6	191	70,0	165	75,3	125	69,3	100	61,1
	6	214	60,1	206	62,0	203	70,1	171	75,9	129	69,8	103	61,5
	7	221	60,4	213	62,3	215	70,1	176	76,4	133	70,4	107	61,9
	10	233	60,9	233	62,9	220	70,5	184	77,2	140	71,3	112	62,7
	15	264	62,1	255	64,4	245	72,4	210	80,2	159	74,3	128	65,1
	18	286	62,9	276	65,4	265	73,8	227	82,3	171	76,5	137	66,8
	20	300	63,5	290	66,2	279	74,7	238	83,8	179	78,0	143	68,1
90.4	5	223	67,9	215	69,3	206	79,3	179	81,5	130	73,0	110	68,3
	6	231	68,3	222	69,7	219	79,4	185	82,1	134	73,5	114	68,7
	7	239	68,8	230	70,2	232	79,6	192	82,7	138	74,1	117	69,2
	10	248	69,2	250	71,5	235	82,8	201	83,7	145	75,1	123	70,2
	15	285	71,3	275	73,0	264	85,4	229	86,7	165	78,5	140	73,2
	18	309	72,6	298	74,5	286	87,3	248	88,9	178	80,8	150	75,3
	20	325	73,5	313	75,6	301	88,6	260	90,5	186	82,5	157	76,9

kWf = cooling capacity in kW
 kWe_tot = Total power input in kW
 To (°C) = Internal exchanger outlet water temperature

Performance in relation to the temperature difference between inlet/outlet water = 5°C*
 * Always check the actual temperature difference on the configurator, as it is linked to the minimum or maximum flow-rate limits of the exchanger

Performances

Cooling - Super-silenced acoustic configuration (EN)

SIZE	To (°C)	Entering external exchanger air temperature (°C)											
		25		30		35		40		45		48	
		kWf	kWe_tot	kWf	kWe_tot	kWf	kWe_tot	kWf	kWe_tot	kWf	kWe_tot	kWf	kWe_tot
45.4	5	88,3	23,4	83,9	25,0	79,6	30,9	68,3	28,7	51,9	25,3	41,0	21,7
	6	91,9	23,4	87,5	25,1	86,1	30,7	71,1	28,9	53,9	25,5	42,4	21,8
	7	95,6	23,5	91,0	25,2	92,6	30,6	74,0	29,0	55,9	25,7	43,9	21,9
	10	101	23,5	102	26,1	92,2	31,1	78,1	29,3	59,5	25,9	46,9	22,1
	15	117	23,5	112	26,4	107	31,2	91,6	29,9	69,4	26,5	54,5	22,5
	18	128	23,5	123	26,4	117	31,4	100	30,1	75,6	26,7	59,1	22,6
	20	136	23,4	130	26,4	123	31,4	106	30,2	79,7	26,8	62,3	22,7
50.4	5	98,7	25,8	93,8	27,7	88,8	34,7	74,6	30,3	56,0	26,6	45,8	23,5
	6	103	25,9	97,7	27,8	94,8	34,7	77,8	30,5	58,1	26,8	47,5	23,6
	7	107	25,9	102	28,0	101	34,7	81,0	30,7	60,3	27,0	49,2	23,8
	10	113	26,0	113	30,0	105	35,8	85,4	31,0	64,1	27,3	52,4	24,0
	15	131	26,1	125	30,3	119	35,9	100	31,6	74,9	27,9	61,1	24,5
	18	143	26,1	137	30,4	130	36,0	110	31,8	81,6	28,2	66,4	24,7
	20	151	26,1	145	30,4	138	36,1	116	32,0	86,1	28,3	69,9	24,7
55.4	5	111	29,7	105	31,5	98,9	41,7	83,1	34,2	61,3	28,0	51,7	26,3
	6	115	29,8	109	31,7	107	41,8	86,7	34,4	63,8	28,2	53,7	26,5
	7	119	30,0	113	31,9	114	41,9	90,2	34,7	66,3	28,4	55,7	26,7
	10	127	30,2	127	34,7	118	42,8	95,5	35,0	70,3	28,7	59,3	27,0
	15	146	30,6	139	35,4	131	44,3	111	35,9	82,4	29,3	69,2	27,7
	18	159	30,8	152	35,8	144	44,9	122	36,3	90,0	29,6	75,4	28,0
	20	168	31,0	160	36,0	152	45,2	129	36,5	95,2	29,8	79,6	28,2
60.4	5	119	25,6	115	29,7	110	35,2	92,5	30,6	71,9	30,3	55,7	26,1
	6	124	25,7	119	29,8	117	35,6	95,6	30,8	74,2	30,5	57,4	26,2
	7	128	25,9	123	30,0	124	35,9	98,7	30,9	76,5	30,6	59,1	26,3
	10	134	26,0	136	31,7	127	36,1	104	31,1	81,4	30,9	63,3	26,5
	15	153	26,5	154	32,0	142	36,3	121	31,6	94,7	31,5	73,9	26,8
	18	166	26,7	167	32,2	155	36,5	132	31,7	104	31,7	81,2	26,8
	20	176	26,8	177	32,2	164	36,5	139	31,7	110	31,8	86,4	26,8
65.4	5	133	35,0	128	36,5	122	42,7	106	42,7	77,3	39,0	65,2	37,5
	6	137	35,2	132	36,7	132	42,8	110	42,9	79,8	39,2	67,3	37,7
	7	142	35,3	137	36,9	141	42,8	114	43,1	82,4	39,4	69,4	37,8
	10	149	35,6	152	36,9	147	43,4	119	43,4	87,5	39,7	74,1	38,1
	15	171	36,2	165	37,7	160	44,1	138	44,0	102	40,4	86,6	38,7
	18	185	36,5	179	38,0	173	44,3	151	44,1	112	40,6	95,1	38,9
	20	196	36,6	189	38,0	183	44,3	160	44,1	118	40,6	101	38,9
70.4	5	157	38,4	151	42,0	145	51,7	123	43,5	91,4	38,9	77,0	39,1
	6	162	38,6	156	42,1	149	52,2	128	43,7	94,5	39,0	79,5	39,3
	7	168	38,8	161	42,2	154	52,6	132	43,9	97,6	39,2	82,1	39,5
	10	176	39,2	167	42,4	163	52,9	139	44,2	103	39,5	87,5	39,9
	15	201	40,0	194	43,7	187	53,2	161	44,8	120	40,1	102	40,6
	18	219	40,5	211	44,1	204	53,1	175	44,9	132	40,2	112	40,9
	20	231	40,8	223	44,3	216	53,3	186	44,9	140	40,2	119	40,9
75.4	5	165	37,8	159	41,9	152	54,3	130	47,8	98,7	43,7	79,6	38,1
	6	171	38,0	164	42,2	161	54,4	135	48,2	102	44,0	81,9	38,3
	7	176	38,2	170	42,4	170	54,4	139	48,6	105	44,4	84,3	38,5
	10	185	38,5	181	43,3	174	54,8	145	49,1	110	45,0	89,1	38,9
	15	210	39,3	202	44,5	195	55,5	166	51,1	125	46,9	101	40,2
	18	227	39,9	219	45,3	210	56,2	179	52,5	135	48,2	109	41,2
	20	238	40,3	230	45,9	221	57,0	187	53,5	141	49,2	114	41,9
80.4	5	175	43,9	168	46,8	162	58,5	141	59,8	101	50,0	84,6	46,0
	6	181	44,1	174	47,1	170	58,7	146	60,3	104	50,3	87,1	46,2
	7	187	44,3	180	47,3	179	59,0	150	60,8	108	50,6	89,5	46,4
	10	196	44,5	192	47,5	183	59,6	157	61,5	113	51,2	94,8	46,9
	15	223	45,2	215	49,1	207	60,1	179	64,1	129	53,1	108	48,4
	18	240	45,7	232	49,8	223	60,0	193	65,9	138	54,5	116	49,5
	20	252	46,0	243	50,4	234	60,8	202	67,2	145	55,5	121	50,3
85.4	5	186	48,2	179	52,4	172	63,4	147	61,0	112	55,8	90,0	48,5
	6	193	48,5	186	52,7	182	64,0	152	61,4	115	56,2	92,7	48,8
	7	200	48,7	192	53,0	191	64,5	157	61,9	119	56,6	95,3	49,0
	10	210	49,1	207	53,4	195	64,8	165	62,6	125	57,3	101	49,6
	15	238	50,2	229	54,8	220	66,2	188	65,1	142	59,7	115	51,3
	18	256	50,9	247	55,8	238	67,2	202	66,9	152	61,5	123	52,6
	20	269	51,4	260	56,6	250	68,2	212	68,2	159	62,8	129	53,5
90.4	5	200	53,4	193	59,0	185	70,5	160	63,5	119	59,5	98	52,1
	6	207	53,7	200	59,5	196	71,2	166	64,0	123	60,0	101	52,5
	7	214	54,1	206	59,9	206	71,8	171	64,4	126	60,5	104	52,8
	10	226	54,6	223	60,8	212	72,4	179	65,1	133	61,3	110	53,5
	15	255	56,1	246	62,4	237	73,5	204	67,5	151	64,1	125	55,5
	18	276	57,2	266	63,8	256	73,2	221	69,3	162	66,1	134	57,0
	20	290	58,0	279	64,8	269	74,4	231	70,5	170	67,6	140	58,1

kWf = cooling capacity in kW

kWe_tot = Total power input in kW

To (°C) = Internal exchanger outlet water temperature

Performance in relation to the temperature difference between inlet/outlet water = 5°C*

* Always check the actual temperature difference on the configurator, as it is linked to the minimum or maximum flow-rate limits of the exchanger

Entire hydraulic circuit of the unit pressure drop - EXC Version

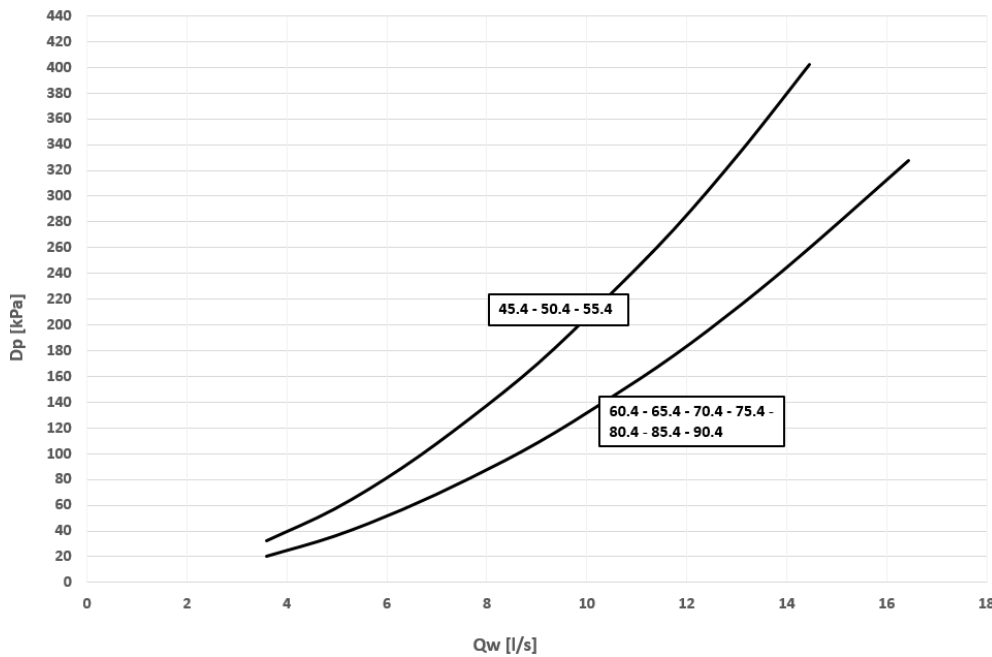

The pressure drops are calculated considering a water temperature of 7°C

Q = Water flow-rate[l/s]
DP = Water side pressure drops [kPa]

The water flow-rate must be calculated with the following formula

$$Q [l/s] = kWf / (4,186 \times DT)$$

kWf = cooling capacity in kW
DT = Temperature difference between inlet / outlet water

⚠ To the pressure drops (internal exchanger, pipes, 3-way valve, free-cooling coils) must be added the pressure drops of the steel mesh mechanical filter that must be placed on the water input line. It is a device compulsory for the correct unit operation, and it is provided by Clivet as accessory.

Admissible water flow-rates

Minimum (Qmin) and maximum (Qmax) admissible water flow rates for correct operation of the unit.

SIZE		45.4	50.4	55.4	60.4	65.4	70.4	75.4	80.4	85.4	90.4
Qmin	[l/s]	2,6	2,6	2,6	3,6	3,6	3,6	3,6	3,6	3,6	3,6
Qmax	[l/s]	13,3	13,3	13,3	18,3	18,3	18,3	18,3	18,3	18,3	18,3

Performances

Entire hydraulic circuit of the unit pressure drop - PRM Version

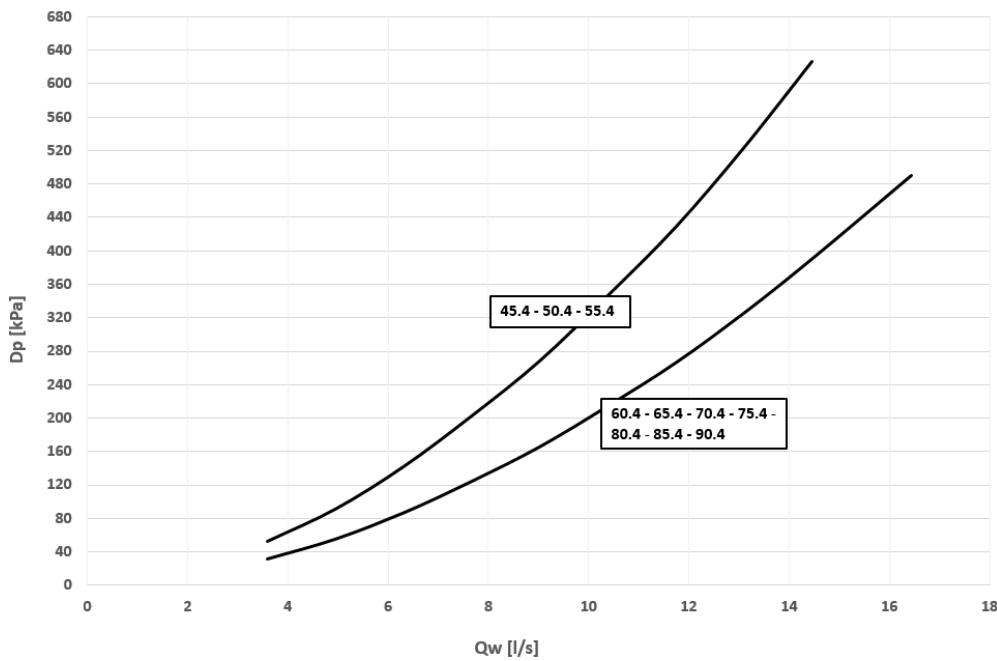

The pressure drops are calculated considering a water temperature of 7°C

Q = Water flow-rate[l/s]
DP = Water side pressure drops [kPa]

The water flow-rate must be calculated with the following formula

$$Q [l/s] = kWf / (4,186 \times DT)$$

kWf = cooling capacity in kW
DT = Temperature difference between inlet / outlet water

⚠ To the pressure drops (internal exchanger, pipes, 3-way valve, free-cooling coils) must be added the pressure drops of the steel mesh mechanical filter that must be placed on the water input line. It is a device compulsory for the correct unit operation, and it is provided by Clivet as accessory.

Admissible water flow-rates

Minimum (Qmin) and maximum (Qmax) admissible water flow rates for correct operation of the unit.

SIZE		45.4	50.4	55.4	60.4	65.4	70.4	75.4	80.4	85.4	90.4
Qmin	[l/s]	2,6	2,6	2,6	3,6	3,6	3,6	3,6	3,6	3,6	3,6
Qmax	[l/s]	13,3	13,3	13,3	18,3	18,3	18,3	18,3	18,3	18,3	18,3

Cooling at part load -

Acoustic configuration with compressor soundproofing (SC)

SIZE	Load	Entering external exchanger air temperature (°C)											
		35°C			30°C			25°C			20°C		
		kWf	kWe_tot	EER	kWf	kWe_tot	EER	kWf	kWe_tot	EER	kWf	kWe_tot	EER
45.4	100	104	33,9	3,07	103	29,3	3,50	107	27,6	3,86	112	24,7	4,53
	75	73,9	25,2	2,94	78,0	22,8	3,43	82,0	20,5	4,00	85,9	18,4	4,68
	50	48,5	15,2	3,20	51,6	13,7	3,77	54,5	12,3	4,45	57,5	11,0	5,24
	Minimum	20,8	7,0	2,98	22,2	6,31	3,52	23,6	5,70	4,14	24,9	5,15	4,84
50.4	100	113	38,5	2,95	112	32,9	3,40	117	30,6	3,84	123	27,2	4,52
	75	80,6	27,3	2,95	85,1	24,7	3,44	89,4	22,3	4,01	93,7	19,9	4,70
	50	54,0	17,0	3,18	57,3	15,3	3,74	60,5	13,7	4,40	63,7	12,3	5,17
	Minimum	21,3	7,09	3,01	22,8	6,40	3,55	24,2	5,78	4,18	25,6	5,23	4,89
55.4	100	129	46,3	2,78	127	37,6	3,37	132	33,5	3,93	138	29,5	4,67
	75	88,8	28,4	3,12	93,6	25,7	3,64	98	23,1	4,25	103	20,6	4,99
	50	60,7	18,4	3,30	64,2	16,6	3,86	67,7	15,0	4,52	71,0	13,4	5,29
	Minimum	23,8	7,38	3,22	25,3	6,69	3,77	26,7	6,06	4,40	28,1	5,48	5,13
60.4	100	143	32,4	4,42	141	38,2	3,70	147	35,6	4,12	152	32,5	4,69
	75	101	30,6	3,29	105	27,4	3,85	110	24,7	4,46	115	22,5	5,09
	50	69,2	20,0	3,46	73,2	17,6	4,16	77,2	15,7	4,91	81,2	14,3	5,67
	Minimum	27,0	7,99	3,38	28,9	7,02	4,12	30,8	6,30	4,89	32,7	5,82	5,62
65.4	100	158	50,8	3,11	153	42,8	3,58	159	42,0	3,79	165	38,3	4,31
	75	111	35,8	3,10	115,8	20,3	5,71	121	29,0	4,15	126	26,5	4,73
	50	74,2	23,0	3,23	29,5	7,8	3,77	82,4	18,1	4,56	86,6	16,5	5,26
	Minimum	28,4	8,89	3,20	29,5	7,82	3,77	32,3	7,01	4,61	34,2	6,47	5,29
70.4	100	173	58,5	2,96	177	50,9	3,47	184	50,6	3,63	190	45,9	4,15
	75	127	40,4	3,14	131	36,4	3,60	136	32,9	4,13	141	30,1	4,71
	50	84,0	25,8	3,26	87,5	22,8	3,84	91,9	20,4	4,51	96,2	18,5	5,21
	Minimum	34,3	10,49	3,27	36,0	9,27	3,88	38,0	8,32	4,57	40,1	7,64	5,25
75.4	100	186	58,1	3,21	183	49,4	3,70	190	45,3	4,19	197	41,6	4,72
	75	134	41,8	3,20	140	37,6	3,72	146	33,8	4,30	151	30,6	4,94
	50	89,1	24,6	3,62	93,6	21,4	4,37	98,0	18,7	5,23	102	16,6	6,18
	Minimum	36,1	9,92	3,64	38,2	8,54	4,47	40,1	6,52	6,16	42,1	6,52	6,45
80.4	100	201	64,1	3,14	198	53,5	3,71	206	53,8	3,83	213	49,5	4,31
	75	145	52,8	2,75	152	47,2	3,21	158	42,3	3,74	164	38,1	4,32
	50	97	30,1	3,24	102	26,0	3,94	107	22,6	4,74	112	19,9	5,63
	Minimum	41,7	13,4	3,11	44,1	11,5	3,82	46,4	9,96	4,65	48,6	8,74	5,57
85.4	100	215	70,1	3,06	213	62,3	3,42	221	60,4	3,66	229	55,5	4,12
	75	156	55,8	2,80	163	50,1	3,25	170	45,1	3,76	176	40,8	4,32
	50	104	32,8	3,16	109	28,5	3,82	114	25,0	4,57	119	22,1	5,40
	Minimum	42,1	13,2	3,18	44,5	11,4	3,91	46,8	9,87	4,74	49,0	8,69	5,64
90.4	100	232	79,6	2,91	230	70,2	3,27	239	68,8	3,47	247	63,2	3,91
	75	165	58,9	2,79	172	53,1	3,23	179	48,0	3,72	185	43,5	4,26
	50	110	35,6	3,09	116	31,2	3,71	121	27,4	4,41	126	24,3	5,18
	Minimum	45,4	14,5	3,13	47,8	12,6	3,81	50,2	11,0	4,58	52,5	9,70	5,42

Load = % of cooling capacity compared to the value at full load

kWf = cooling capacity in kW

kWe_tot = Total power input in kW

Internal heat exchanger water temperature = outlet 7°C / inlet 12°C / variable flow-rate with external exchanger air T.

Performances

Cooling at part load

Super-silenced acoustic configuration (EN)

SIZE	Load	Entering external exchanger air temperature (°C)											
		35°C			30°C			25°C			20°C		
		kWf	kWe_tot	EER	kWf	kWe_tot	EER	kWf	kWe_tot	EER	kWf	kWe_tot	EER
45.4	100	92,6	30,6	3,03	91	25,2	3,61	96	23,5	4,07	100	21,0	4,77
	75	66,9	21,7	3,08	70,8	19,7	3,60	74,5	17,7	4,21	78,1	15,9	4,92
	50	44,2	13,2	3,34	47,2	11,9	3,98	50,0	10,6	4,71	52,8	9,5	5,57
	Minimum	20,0	6,51	3,08	21,4	5,87	3,65	22,8	5,30	4,30	24,1	4,79	5,04
50.4	100	101	34,7	2,90	102	28,0	3,63	107	25,9	4,12	112	23,1	4,84
	75	73,1	23,1	3,16	77,2	20,9	3,69	81,2	18,8	4,31	85,2	16,9	5,04
	50	47,2	13,7	3,44	50,2	12,3	4,08	53,2	11,0	4,83	56,1	9,8	5,70
	Minimum	21,4	6,73	3,18	22,9	6,08	3,76	24,3	5,49	4,43	25,7	4,97	5,18
55.4	100	114	41,9	2,74	113	31,9	3,55	119	30,0	3,97	125	26,5	4,70
	75	81,4	25,6	3,18	85,8	23,2	3,70	90,2	20,8	4,33	94	18,6	5,08
	50	54,1	15,8	3,43	57,4	14,2	4,03	60,5	12,8	4,72	63,6	11,5	5,53
	Minimum	21,8	6,65	3,28	23,2	6,02	3,86	24,6	5,45	4,52	25,9	4,92	5,27
60.4	100	124	35,9	3,45	123	30,0	4,09	128	25,9	4,94	133	23,6	5,62
	75	90	24,0	3,74	94	21,4	4,40	98	19,2	5,13	103	17,4	5,89
	50	61,1	15,0	4,08	64,8	13,1	4,94	68,6	11,7	5,86	72,4	10,7	6,77
	Minimum	26,3	6,71	3,91	28,1	5,90	4,77	29,9	5,29	5,66	31,8	4,89	6,51
65.4	100	141	42,8	3,29	137	36,9	3,71	142	35,3	4,02	147	32,3	4,57
	75	67	21,1	3,17	104	28,4	3,67	109	25,5	4,26	113	23,3	4,87
	50	67,9	20,4	3,33	71,9	17,9	4,02	75,9	16,0	4,76	79,9	14,6	5,49
	Minimum	26,2	8,09	3,24	28,1	7,09	3,96	30,0	6,36	4,72	31,9	5,88	5,42
70.4	100	154	52,6	2,93	161	42,2	3,83	168	38,8	4,32	174	35,3	4,94
	75	117	32,8	3,55	122	29,5	4,14	127	26,6	4,78	132	24,3	5,45
	50	76,9	20,5	3,75	81,3	18,1	4,50	85,6	16,1	5,31	90,0	14,7	6,13
	Minimum	30,3	8,23	3,69	31,5	7,24	4,35	34,4	6,49	5,31	36,5	5,99	6,10
75.4	100	170	54,4	3,13	170	42,4	4,00	176	38,2	4,61	183	34,9	5,23
	75	124	36,6	3,40	130	32,7	3,98	136	29,2	4,64	141	26,3	5,37
	50	83,2	20,9	3,98	87,6	18,0	4,86	91,8	15,6	5,87	96,0	13,7	7,00
	Minimum	36,9	9,76	3,78	39,0	8,38	4,65	41,0	7,25	5,66	43,0	6,36	6,76
80.4	100	179	59,0	3,04	180	47,3	3,81	187	44,3	4,23	194	40,5	4,79
	75	130	42,6	3,04	136	37,8	3,59	142	33,6	4,21	147	30,1	4,90
	50	87,5	24,5	3,57	92,3	20,9	4,41	97,0	18,0	5,38	102	15,7	6,45
	Minimum	43,8	13,0	3,37	46,2	11,2	4,12	48,5	9,76	4,97	50,8	8,61	5,90
85.4	100	191	64,5	2,96	192	53,0	3,63	200	48,7	4,09	207	44,6	4,64
	75	141	46,7	3,02	147	41,6	3,53	153	37,3	4,12	160	33,5	4,77
	50	94,1	26,7	3,53	99	23,0	4,31	104	19,9	5,21	109	17,5	6,21
	Minimum	41,7	12,4	3,35	44,1	10,7	4,12	46,4	9,24	5,02	48,6	8,10	6,00
90.4	100	206	71,8	2,87	206	59,9	3,45	214	54,1	3,96	222	49,5	4,49
	75	149	48,9	3,04	155	43,8	3,55	162	39,3	4,12	168	35,4	4,75
	50	101	28,6	3,52	106	24,8	4,26	111	21,6	5,12	116	19,1	6,06
	Minimum	41,7	12,20	3,42	44,1	10,5	4,21	46,4	9,06	5,12	48,6	7,94	6,12

Load = % of cooling capacity compared to the value at full load

kWf = cooling capacity in kW

kWe_tot = Total power input in kW

Internal heat exchanger water temperature = outlet 7°C / inlet 12°C / variable flow-rate with external exchanger air T.

D - Partial energy recovery

A configuration which enables the production of hot water free-of-charge while operating in the cooling mode, thanks to the partial recovery of condensation heat that would otherwise be disposed of into the external heat source.

This option is also known as “desuperheater”. It is made up of a Innox 316 stainless steel brazed plate heat exchangers, suitable for recovering a part of the capacity dispersed by the unit (the dispersed heating capacity is equal to the sum of the cooling capacity and the electrical input capacity of the compressors).

The partial recovery device is considered to be operating when it is powered by the water flow which is to be heated. This condition improves the unit performance, since it reduces the condensation temperature: in nominal conditions the cooling capacity increases indicatively by 3.2% and the power input of the compressors is reduced by 3.6%.

When the temperature of water to be heated is particularly low, it is necessary to control the flow-rate to maintain the outlet temperature at recovery above 35°C and prevent condensation of the refrigerant in the partial energy recovery device.

The water connections of the partial energy recovery device are 1” 1/4 for all sizes.

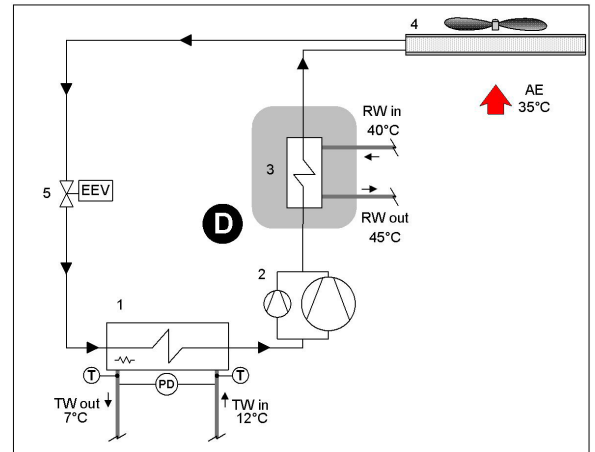

D - Partial recovery device

- 1 - Internal exchanger
- 2 - Compressors
- 3 - Recovery exchanger
- 4 - External exchanger
- 5 - Electronic expansion valve

- TW in chilled water inlet
- TW out chilled water outlet
- RW in - Ingresso acqua recupero
- RW out - Uscita acqua recupero
- T - Temperature probe
- PD - Differential pressure switch
- AE Aria esterna

Partial recovery heating capacity

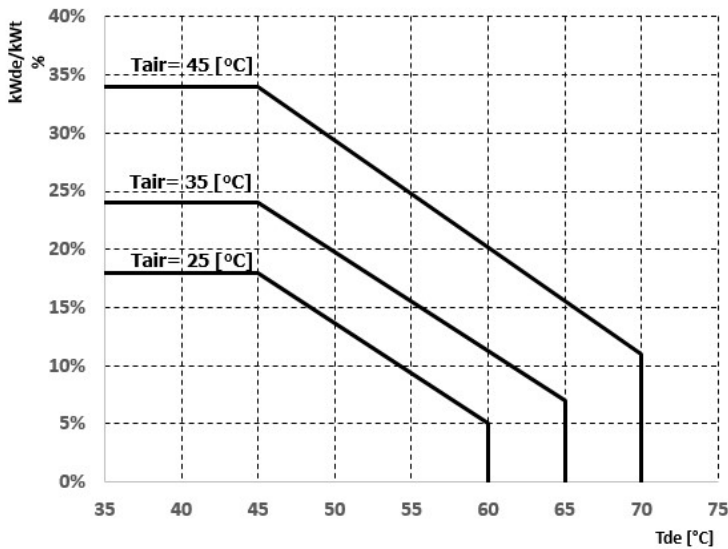

$kWde/kWt = \text{Heat recovered} / \text{Condenser heating capacity (cooling capacity + compressor power input)} [\%]$
 $Tde = \text{Desuperheater water outlet temperature } [^{\circ}\text{C}]$

Configurations

Partial energy recovery exchanger pressure drops

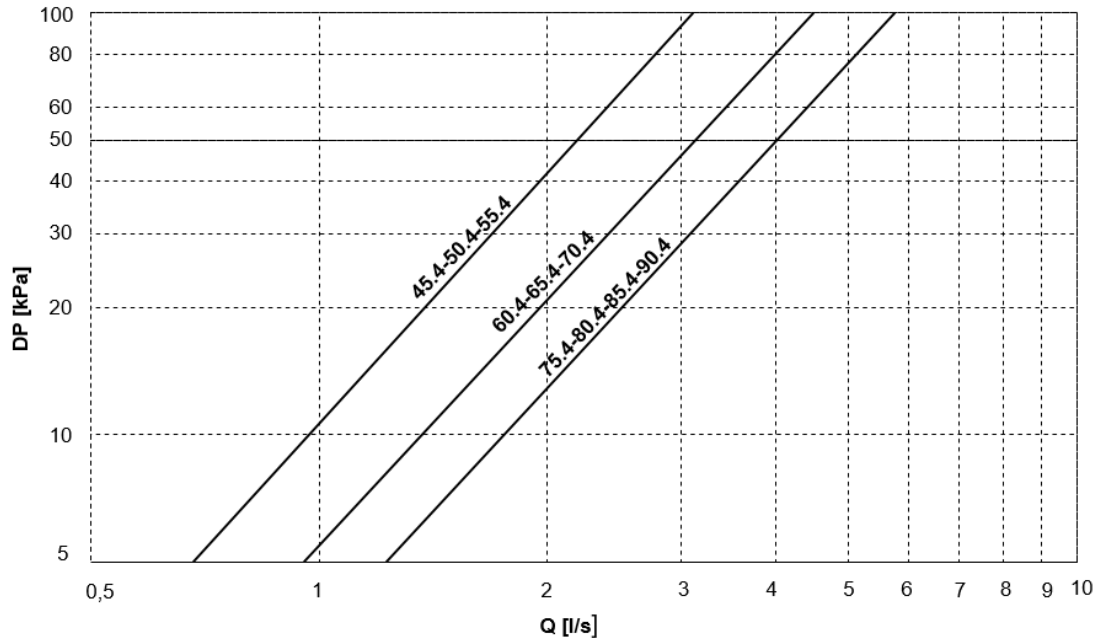

Q = Water flow-rate[l/s]

DP = Water side pressure drops [kPa]

Admissible water flow-rates

Minimum (Qmin) and maximum (Qmax) admissible water flow rates for correct operation of the unit.

SIZE		45.4	50.4	55.4	60.4	65.4	70.4	75.4	80.4	85.4	90.4
Qmin	[l/s]	0,7	0,7	0,7	1,0	1,0	1,0	1,2	1,2	1,2	1,2
Qmax	[l/s]	3,1	3,1	3,1	4,5	4,5	4,5	5,7	5,7	5,7	5,7

1PM - HydroPack with N° 1 pump

Pumping group consisting of an electric centrifugal pump with cast iron pump body and stainless steel or cast iron impeller (depending on the model).

Mechanical seal using ceramic, carbon and EPDM elastomer components.

Three-phase electric motor with IP55 protection rating. Complete with thermoformed insulating casing, quick-release couplings with an insulated casing, safety valve, pressure gauges, system load safety pressure switch, stainless steel immersion antifreeze heaters fitted on the supply and suction lines.

All the water connections are Victaulic.

Option supplied on the unit.

CONNECTION DIAGRAM 1PM - Group with n° 1 pump

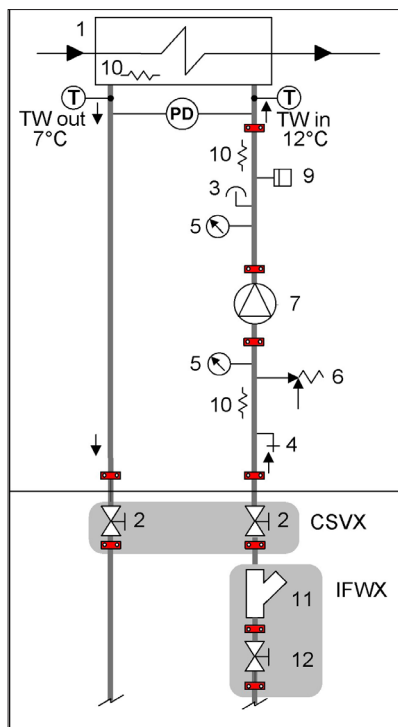

- 1 - Internal exchanger
- 2 - Cutoff valve - (CSVX - Couple of manually operated shut-off valves)
- 3 - Vent valve
- 4 - Discharge stop valve
- 5 - Pressure gauge
- 6 - Safety valve (6 Bar)
- 7 - Packaged electric pump with high efficiency impeller
- 9 - System load safety pressure switch (it avoids the pump operation if water is not present)
- 10 - Antifreeze heater
- 11 - Steel mesh strainer water side - (IFWX)
- 12 - Cutoff valve with quick joints

T - Temperature probe
PD - Differential pressure switch

TW in chilled water inlet
TW out chilled water outlet

The grey area indicates further optional components.

- ⚠ Provide hydraulic interceptions outside the unit ('CSVX - Couple of manually operated shut-off valves' option) to facilitate any possible extraordinary maintenance interventions.
- ⚠ **It is necessary to provide a non-return valve for each unit installed in hydraulic parallel and equipped with an hydronic assembly installed on board (Installation by the Customer).**

Hydropack electrical data

PUMP	Nominal capacity [kW]	Rated power [kW]
1PM 45.4-60.4 EXC/PRM	1,5	3,17
1PM 65.4-90.4 EXC / 65.4-85.4 PRM	2,2	4,56
1PM 90.4 PRM	3,0	6,33

Accessories - Hydronic assembly

1PM - HydroPack with N° 1 pump

Head

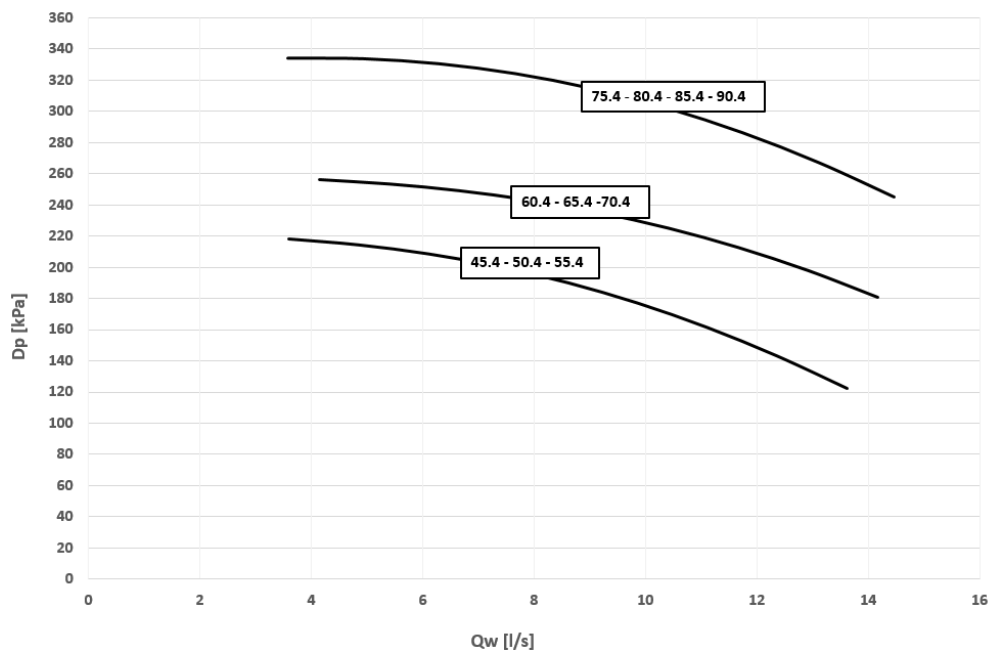

Dp = Pump head [kPa]
QW = Water flow-rate [l/s]

Power input

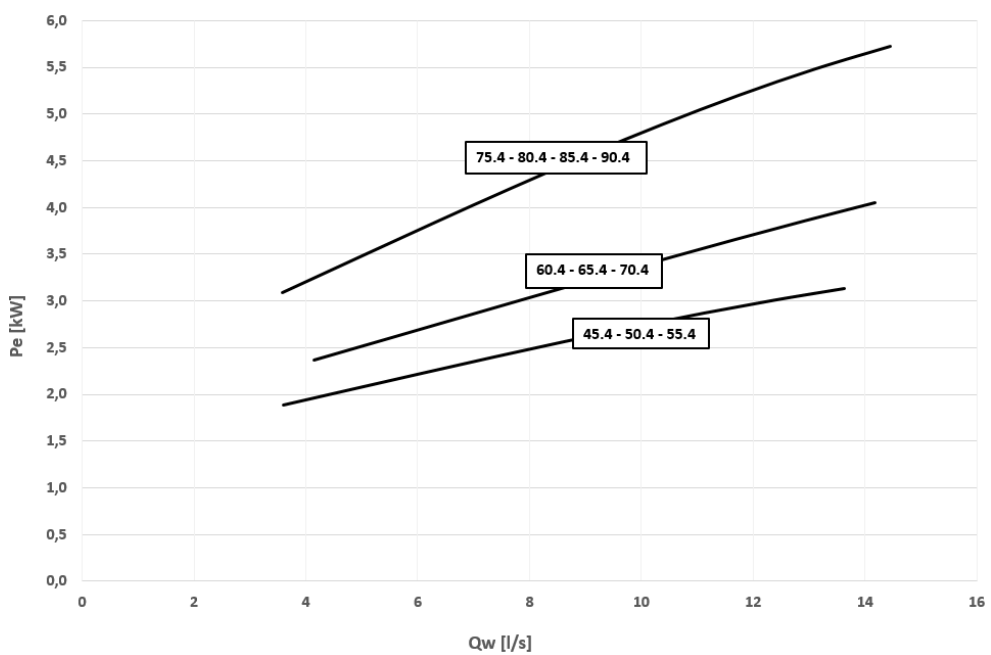

Pe = Power input [kW]
QW = Water flow-rate [l/s]

1PMH - HydroPack with N° 1 high static pressure pump

Pumping group consisting of an electric centrifugal pump with cast iron pump body and stainless steel or cast iron impeller (depending on the model).

Mechanical seal using ceramic, carbon and EPDM elastomer components.

Three-phase electric motor with IP55 protection rating. Complete with thermoformed insulating casing, quick-release couplings with an insulated casing, safety valve, pressure gauges, system load safety pressure switch, stainless steel immersion antifreeze heaters fitted on the supply and suction lines.

All water fittings are Victaulic.

Option supplied on the unit.

CONNECTION DIAGRAM 1PMH - Group with 1 high head pump

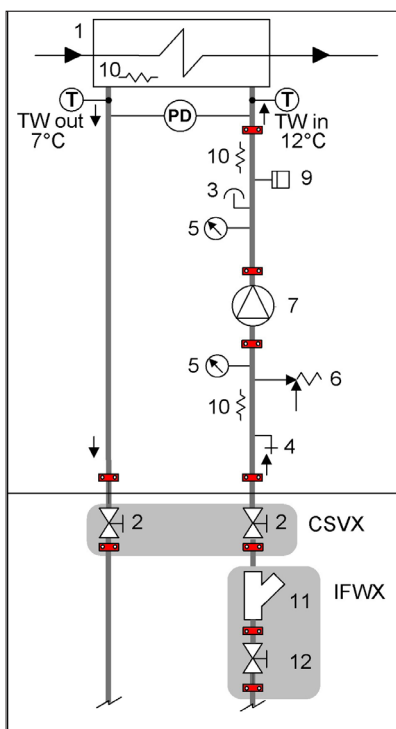

- 1 - Internal exchanger
- 2 - Cutoff valve - (CSVX - Couple of manually operated shut-off valves)
- 3 - Vent valve
- 4 - Discharge stop valve
- 5 - Pressure gauge
- 6 - Safety valve (6 Bar)
- 7 - Packaged electric pump with high efficiency impeller
- 9 - System load safety pressure switch (it avoids the pump operation if water is not present)
- 10 - Antifreeze heater
- 11 - Steel mesh strainer water side - (IFWX)
- 12 - Cutoff valve with quick joints

T - Temperature probe
PD - Differential pressure switch

TW in chilled water inlet
TW out chilled water outlet

The grey area indicates further optional components.

- ⚠ Provide hydraulic interceptions outside the unit ('CSVX - Couple of manually operated shut-off valves' option) to facilitate any possible extraordinary maintenance interventions.
- ⚠ **It is necessary to provide a non-return valve for each unit installed in hydraulic parallel and equipped with an hydronic assembly installed on board (Installation by the Customer).**

Hydropack electrical data

POMPA	Potenza nominale [kW]	Corrente assorbita nominale [A]
1PMH 45.4-60.4 EXC/PRM	3,0	6,33
1PMH 65.4-90.4 EXC/PRM	4,0	7,62

Accessories - Hydronic assembly

1PMH - HydroPack with N° 1 high static pressure pump

Head

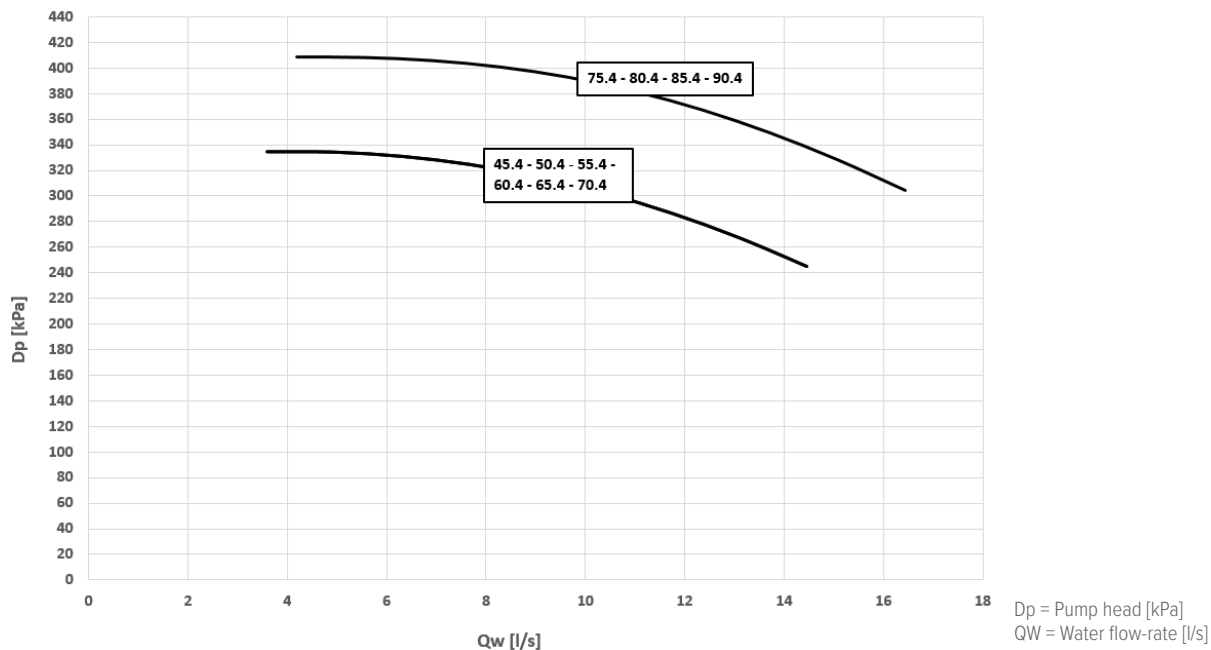

Power input

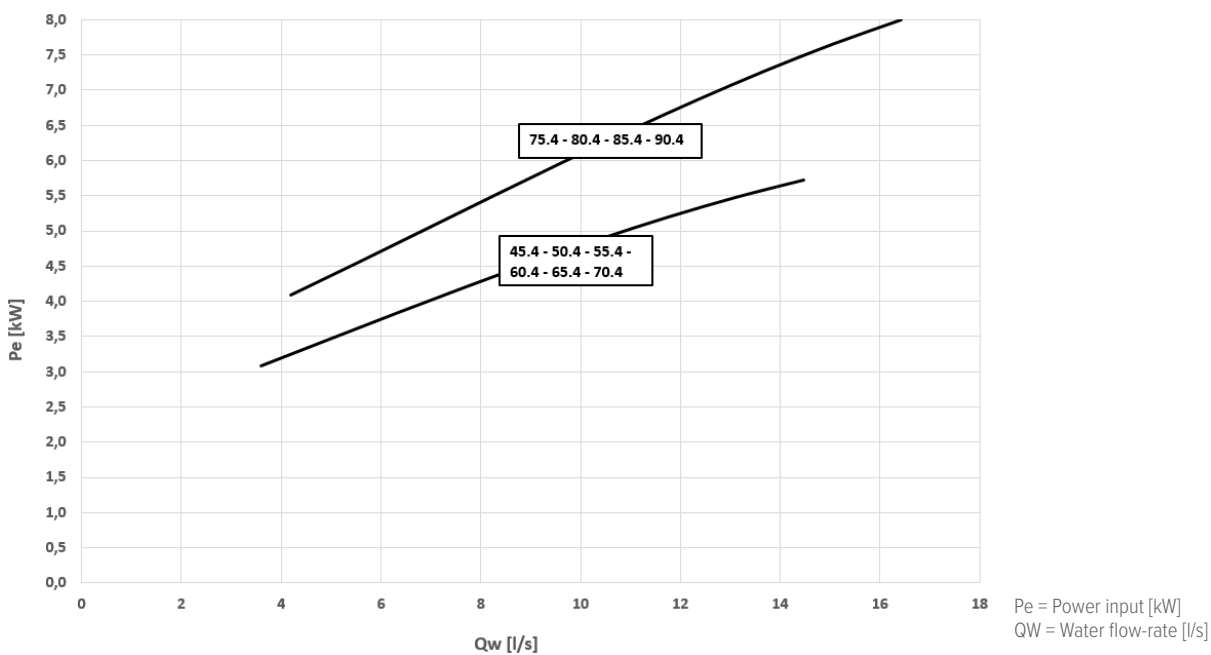

1PMV - User side Hydropack with 1 inverter pump

Pumping group consisting of an electric pump controlled by inverter to adapt to different conditions of use.

It enables the automatic reduction of the liquid flow-rate in critical conditions, avoiding blocks due to overloading and consequential intervention work by specialised technical personnel.

Through the inverter calibration, standard supplied, it is possible to adapt the pump flow-rate/head to the installation feature.

Centrifugal electric pump with the pump body made of cast iron and the impeller made stainless steel or cast iron (depending on the models)

Mechanical seal using ceramic, carbon and EPDM elastomer components.

Three-phase electric motor with IP55 protection rating. Complete with thermoformed insulating casing, quick-release couplings with an insulated casing, safety valve, pressure gauges, system load safety pressure switch, stainless steel immersion antifreeze heaters fitted on the suction and supply lines.

In combination with the "IVFDT" - Variable flow-rate control option, it allows variation of the water flow-rate to the system under partial-load to achieve the highest unit efficiency and lower consumption of the pumping group.

All water fittings are Victaulic.

Option supplied on the unit.

CONNECTION DIAGRAM 1PMV - Group with n° 1 inverter pump

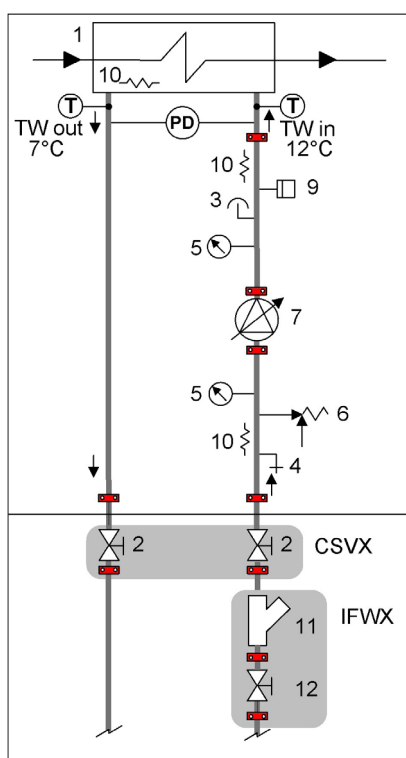

- 1 - Internal exchanger
- 2 - Cutoff valve - (CSVX - Couple of manually operated shut-off valves)
- 3 - Vent valve
- 4 - Discharge stop valve
- 5 - Pressure gauge
- 6 - Safety valve (6 Bar)
- 7 - Packaged electric pump with high efficiency impeller
- 9 - System load safety pressure switch (it avoids the pump operation if water is not present)
- 10 - Antifreeze heater
- 11 - Steel mesh strainer water side - (IFWX)
- 12 - Cutoff valve with quick joints

T - Temperature probe
PD - Differential pressure switch

TW in chilled water inlet
TW out chilled water outlet

The grey area indicates further optional components.

- ⚠ Provide hydraulic interceptions outside the unit ('CSVX - Couple of manually operated shut-off valves' option) to facilitate any possible extraordinary maintenance interventions.
- ⚠ It is necessary to provide a non-return valve for each unit installed in hydraulic parallel and equipped with an hydronic assembly installed on board (Installation by the Customer).

Hydropack electrical data

POMPA	Potenza nominale [kW]	Corrente assorbita nominale [A]
1PMV 45.4-60.4 EXC/PRM	1,5	3,17
1PMV 65.4-90.4 EXC / 65.4-85.4 PRM	2,2	4,56
1PMV 90.4 PRM	3,0	6,33

Accessories - Hydronic assembly

1PMV - User side Hydropack with 1 inverter pump

Head - Size 45.4 - 55.4 EXC/PRM

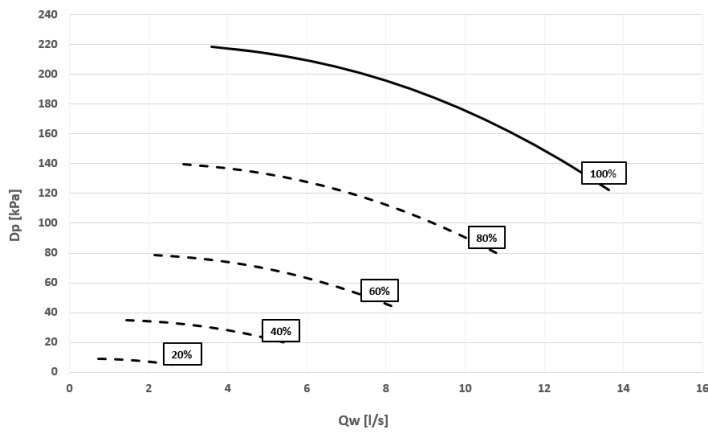

Power input - Size 45.4 - 55.4 EXC/PRM

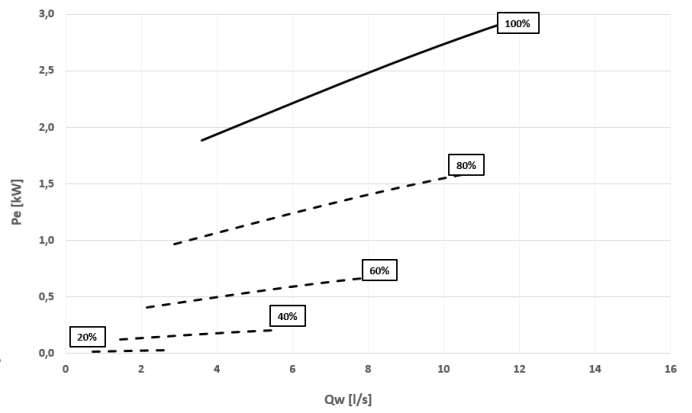

Dp = Pump head [kPa]
QW = Water flow-rate [l/s]

Pe = Power input [kW]
QW = Water flow-rate [l/s]

Head - Size 60.4 - 70.4 EXC/PRM

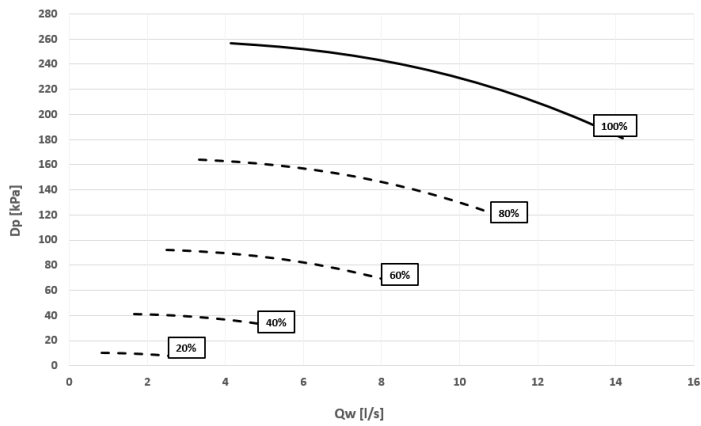

Power input 60.4 - 70.4 EXC/PRM

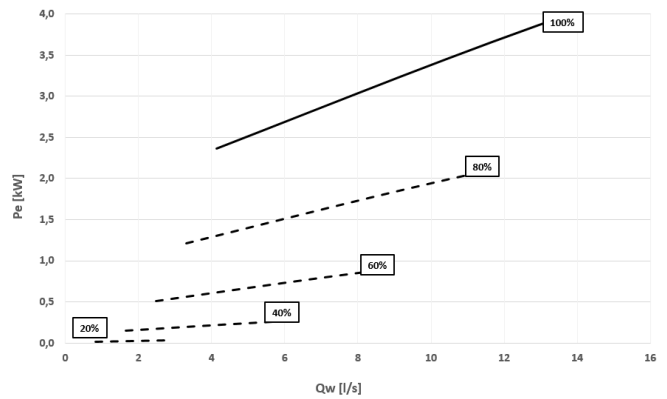

Dp = Pump head [kPa]
QW = Water flow-rate [l/s]

Pe = Power input [kW]
QW = Water flow-rate [l/s]

Head - Size 75.4 - 90.4 PRM

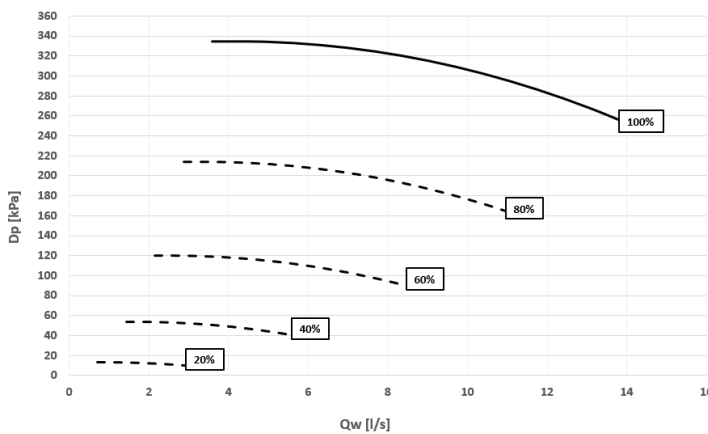

Power input - Size 75.4 - 90.4 PRM

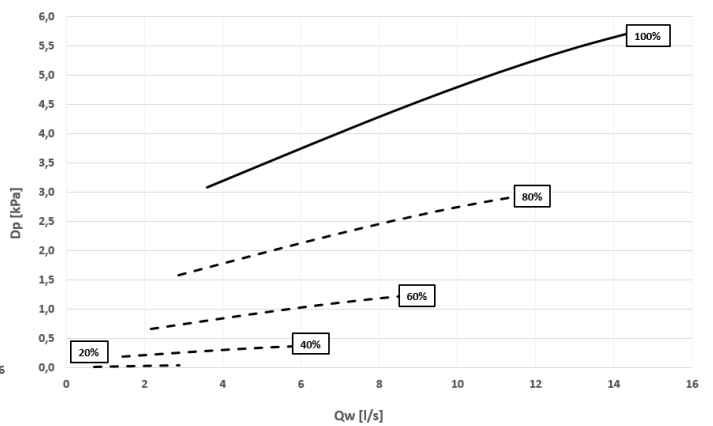

Dp = Pump head [kPa]
QW = Water flow-rate [l/s]

Pe = Power input [kW]
QW = Water flow-rate [l/s]

1PMVH - User side Hydropack with 1 high head inverter pump

Pumping group consisting of an electric pump controlled by inverter to adapt to different conditions of use.

It enables the automatic reduction of the liquid flow-rate in critical conditions, avoiding blocks due to overloading and consequential intervention work by specialised technical personnel.

Through the inverter calibration, standard supplied, it is possible to adapt the pump flow-rate/head to the installation feature.

Centrifugal electric pump with the pump body made of cast iron and the impeller made stainless steel or cast iron (depending on the models)

Mechanical seal using ceramic, carbon and EPDM elastomer components.

Three-phase electric motor with IP55 protection rating. Complete with thermoformed insulating casing, quick-release couplings with an insulated casing, safety valve, pressure gauges, system load safety pressure switch, stainless steel immersion antifreeze heaters fitted on the suction and supply lines.

In combination with the "IVFDT" - Variable flow-rate control option, it allows variation of the water flow-rate to the system under partial-load to achieve the highest unit efficiency and lower consumption of the pumping group.

All water fittings are Victaulic.

Option supplied on the unit.

CONNECTION DIAGRAM 1PMVH - Group with 1 inverter pump

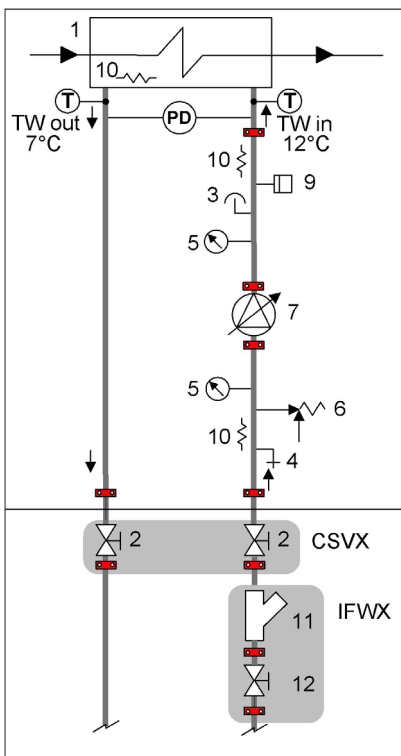

- 1 - Internal exchanger
- 2 - Cutoff valve - (CSVX - Couple of manually operated shut-off valves)
- 3 - Vent valve
- 4 - Discharge stop valve
- 5 - Pressure gauge
- 6 - Safety valve (6 Bar)
- 7 - Packaged electric pump with high efficiency impeller
- 9 - System load safety pressure switch (it avoids the pump operation if water is not present)
- 10 - Antifreeze heater
- 11 - Steel mesh strainer water side - (IFWX)
- 12 - Cutoff valve with quick joints

T - Temperature probe
PD - Differential pressure switch

TW in chilled water inlet
TW out chilled water outlet

The grey area indicates further optional components.

- ⚠ Provide hydraulic interceptions outside the unit ("CSVX - Couple of manually operated shut-off valves" option) to facilitate any possible extraordinary maintenance interventions.
- ⚠ It is necessary to provide a non-return valve for each unit installed in hydraulic parallel and equipped with an hydronic assembly installed on board (Installation by the Customer).

Hydropack electrical data

POMPA	Potenza nominale [kW]	Corrente assorbita nominale [A]
1PMVH 45.4-60.4 EXC/PRM	3,0	6,33
1PMVH 65.4-90.4 EXC/PRM	4,0	7,62

Accessories - Hydronic assembly

1PMVH - User side Hydropack with 1 high head inverter pump

Head - Size 45.4 - 55.4 EXC/PRM

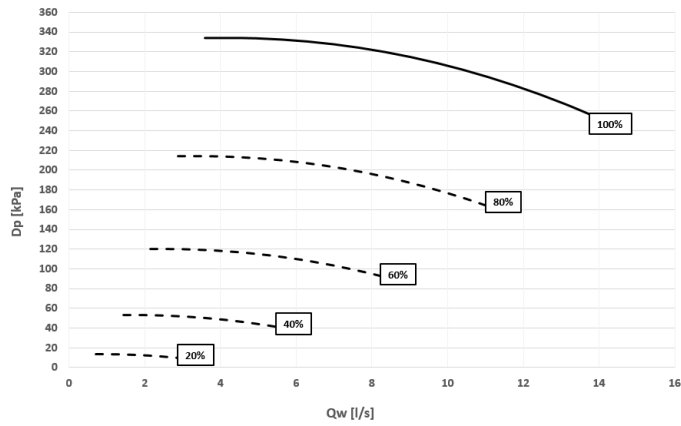

Dp = Pump head [kPa]
Qw = Water flow-rate [l/s]

Power input - Size 45.4 - 55.4 EXC/PRM

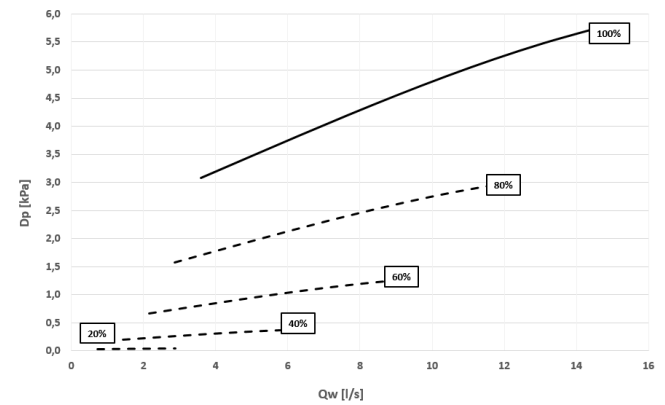

Pe = Power input [kW]
Qw = Water flow-rate [l/s]

Head - Size 60.4 - 90.4 EXC/PRM

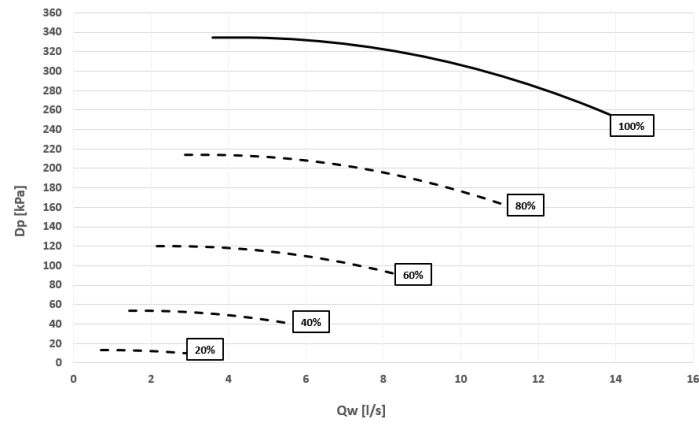

Dp = Pump head [kPa]
Qw = Water flow-rate [l/s]

Power input - Size 60.4 - 90.4 EXC/PRM

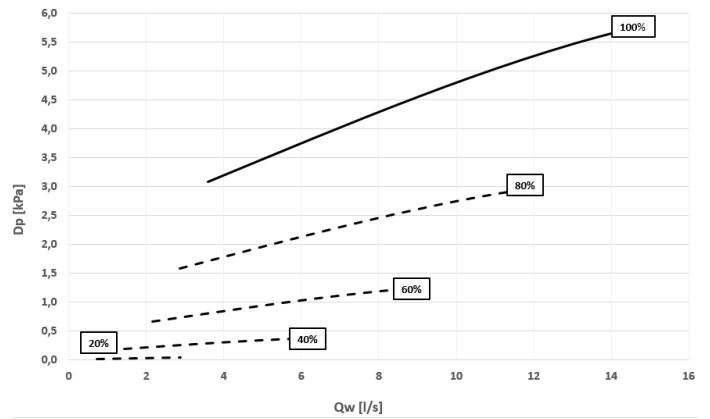

Pe = Power input [kW]
Qw = Water flow-rate [l/s]

1P1SB - Hydropack with 1 pump + 1 stand-by

Pumping group consisting of 1+1 electric pump (1 stand-by) with cast iron pump body and stainless steel or cast iron impeller (depending on the model). Mechanical seal using ceramic, carbon and EPDM elastomer components.

Three-phase electric motor with IP55 protection rating. Complete with thermoformed insulating casing, quick-release couplings with an insulated casing, safety valve, pressure gauges, system load safety pressure switch, stainless steel immersion antifreeze heaters fitted on the supply and suction lines.

All water fittings are Victaulic.

Option supplied on the unit.

CONNECTION DIAGRAM 1P1SB - Hydropack with 1 pump + 1 stand-by

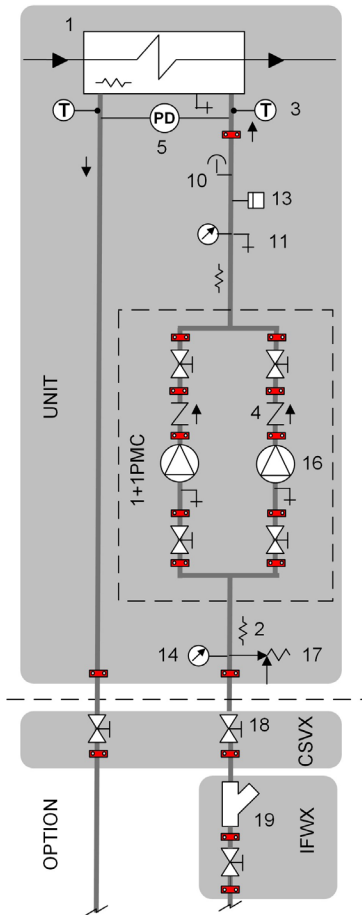

1. Exchanger
2. Antifreeze heater
3. Water temperature probe
4. Non-return valve
5. Differential pressure switch
10. Vent
11. Drain
13. System load safety pressure switch
14. Pressure gauge
16. Packaged electric pump with high efficiency impeller
17. Safety valve
18. Shut-off valve
19. Filter

T - Temperature probe
PD - Differential pressure switch

TW in chilled water inlet
TW out chilled water outlet

- ⚠ Provide hydraulic interceptions outside the unit ('CSVX - Couple of manually operated shut-off valves' option) to facilitate any possible extraordinary maintenance interventions.
- ⚠ The head and consumption graphs of the pumping group refer to operation with pure water. If there is a water-glycol mix, please contact Clivet's office to check the correct operating point of the pumping group.

Hydropack electrical data

PUMP	Nominal capacity [kW]	Rated current input [A]
1P1SB 45.4-60.4 EXC/PRM	1,5	3,17
1P1SB 65.4-90.4 EXC / 65.4-85.4 PRM	2,2	4,56
1P1SB 90.4 PRM	3,0	6,33

Accessories - Hydronic assembly

1P1SB - Hydropack with 1 pump + 1 stand-by

Head

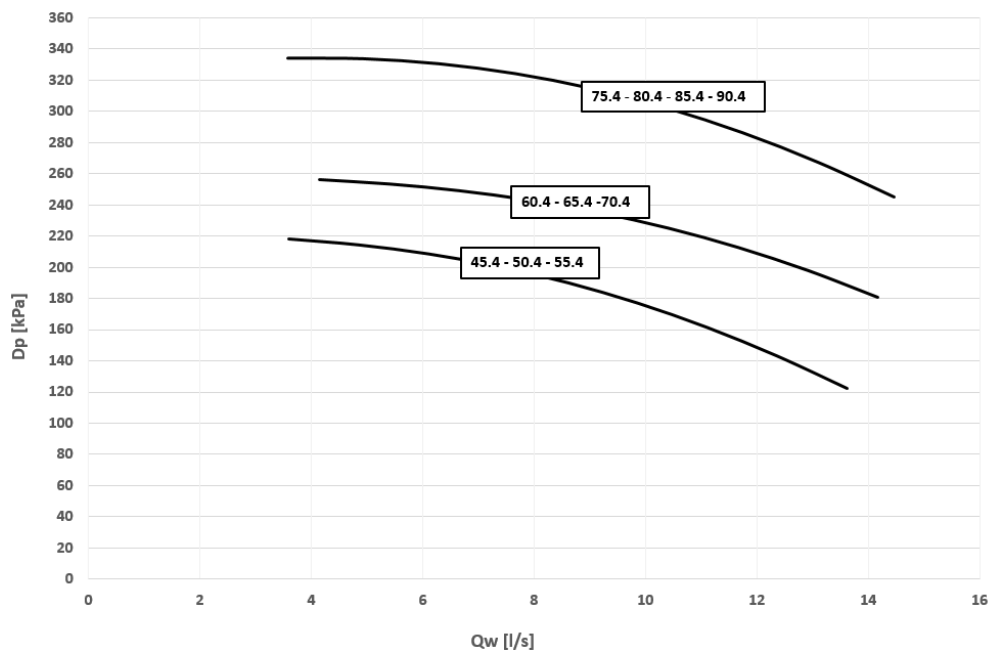

Dp = Pump head [kPa]
QW = Water flow-rate [l/s]

Power input

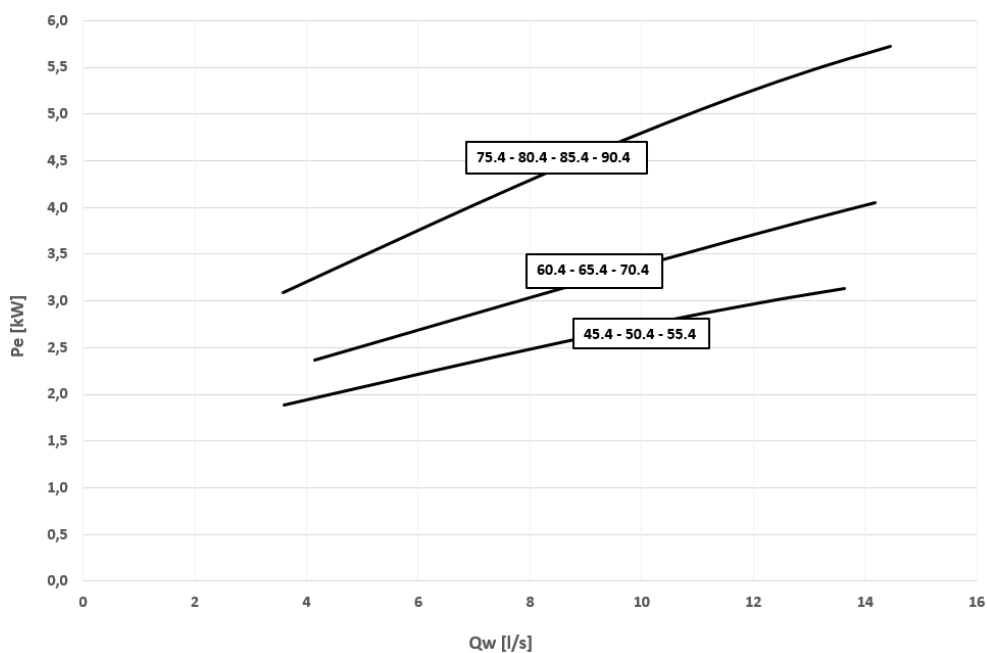

Pe = Power input [kW]
QW = Water flow-rate [l/s]

1PAP+S - Hydropack with 1 high head pump + 1 standby

Pumping group consisting of 1+1 electric pump (1 stand-by) with cast iron pump body and stainless steel or cast iron impeller (depending on the model). Mechanical seal using ceramic, carbon and EPDM elastomer components.

Three-phase electric motor with IP55 protection rating. Complete with thermoformed insulating casing, quick-release couplings with an insulated casing, safety valve, pressure gauges, system load safety pressure switch, stainless steel immersion antifreeze heaters fitted on the supply and suction lines.

All water fittings are Victaulic.

Option supplied on the unit.

CONNECTION DIAGRAM 1PAP+S - Group with 1 high head pump + 1 standby

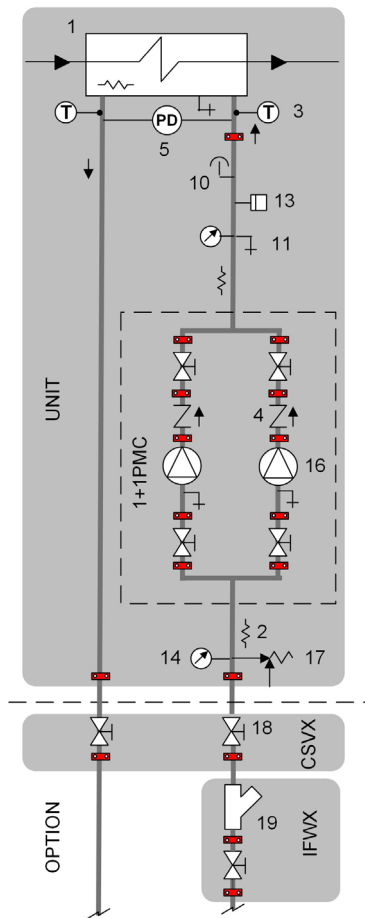

1. Exchanger
2. Antifreeze heater
3. Water temperature probe
4. Non-return valve
5. Differential pressure switch
10. Vent
11. Drain
13. System load safety pressure switch
14. Pressure gauge
16. Packaged electric pump with high efficiency impeller
17. Safety valve
18. Shut-off valve
19. Filter

T - Temperature probe
PD - Differential pressure switch

TW in chilled water inlet
TW out chilled water outlet

- ⚠ Provide hydraulic interceptions outside the unit ('CSVX - Couple of manually operated shut-off valves' option) to facilitate any possible extraordinary maintenance interventions.
- ⚠ The head and consumption graphs of the pumping group refer to operation with pure water. If there is a water-glycol mix, please contact Clivet's office to check the correct operating point of the pumping group.

Hydropack electrical data

PUMP	Nominal capacity [kW]	Rated power [kW]
1PAP+S 45.4-60.4 EXC/PRM	3,0	6,33
1PAP+S 65.4-90.4 EXC/PRM	4,0	7,62

Accessories - Hydronic assembly

1PAP+S - Hydropack with 1 high head pump + 1 standby

Head

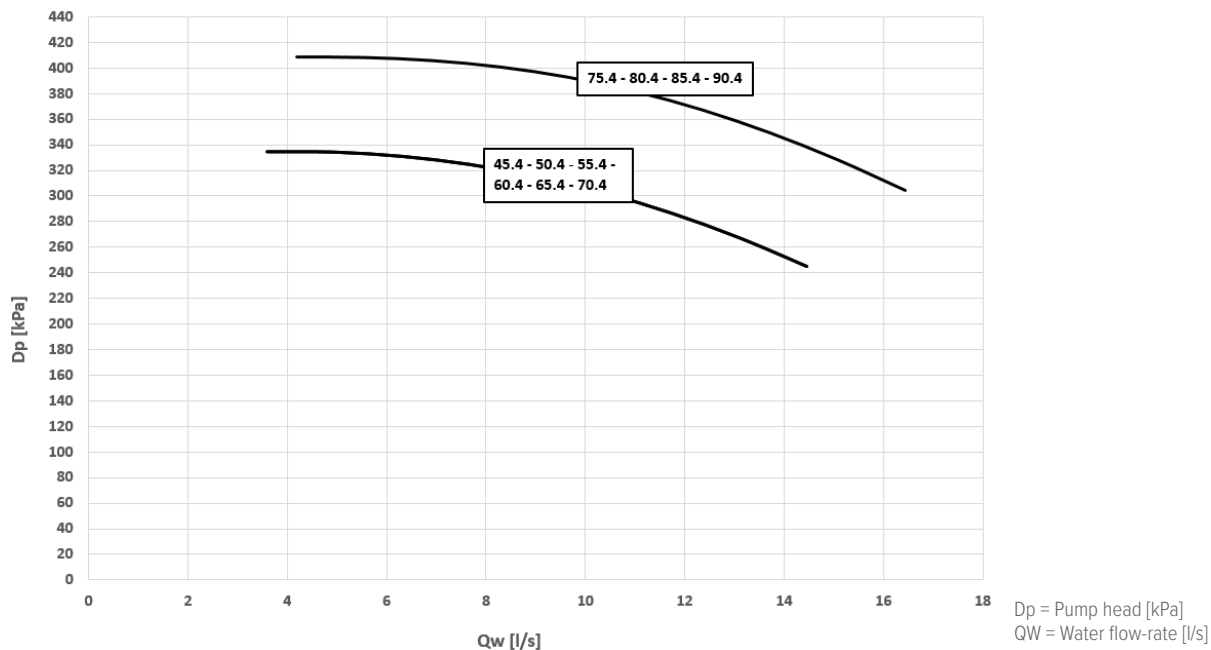

Power input

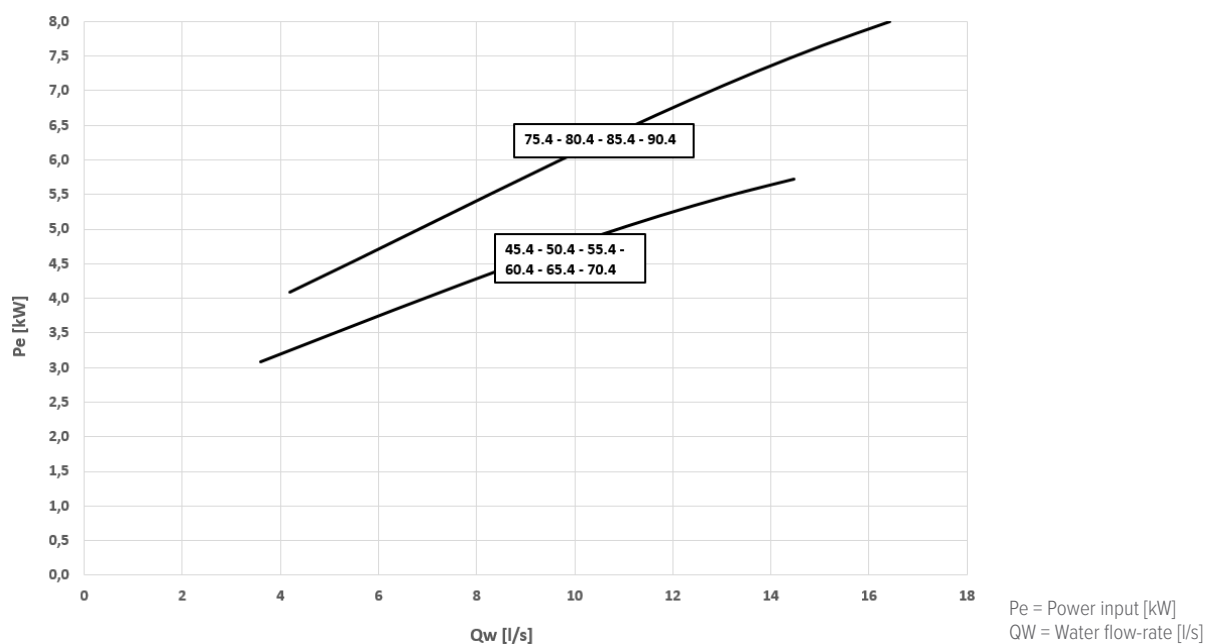

1P1SBV - User side Hydropack with 1 inverter pump and 1 stand-by pump with dedicated inverter

Pumping group consisting of 1+1 electric pump (1 stand-by) with cast iron pump body and stainless steel or cast iron impeller (depending on the model). Mechanical seal using ceramic, carbon and EPDM elastomer components.

Three-phase electric motor with IP55 protection rating. Complete with thermoformed insulating casing, quick-release couplings with an insulated casing, safety valve, pressure gauges, system load safety pressure switch, stainless steel immersion antifreeze heaters fitted on the supply and suction lines.

All water fittings are Victaulic.

Option supplied on the unit.

CONNECTION DIAGRAM 1P1SBV - Group with 1 inverter pump and 1 stand-by pump with dedicated inverter

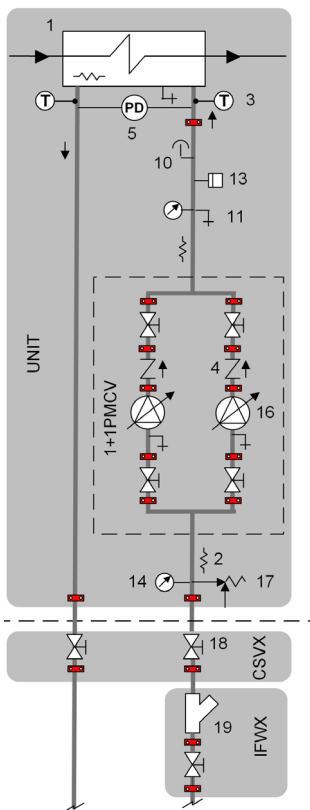

1. Exchanger
2. Antifreeze heater
3. Water temperature probe
4. Non-return valve
5. Differential pressure switch
10. Vent
11. Drain
13. System load safety pressure switch
14. Pressure gauge
16. Packaged electric pump with high efficiency impeller
17. Safety valve
18. Shut-off valve
19. Filter

T - Temperature probe
PD - Differential pressure switch

TW in chilled water inlet
TW out chilled water outlet

⚠ Provide hydraulic interceptions outside the unit ('CSVX - Couple of manually operated shut-off valves' option) to facilitate any possible extraordinary maintenance interventions.

⚠ The head and absorption graphs of the hydronic assembly refer to operation with pure water. In the presence of a mixture of water and glycol, please contact Clivet office to check the correct operating point of the hydronic assembly.

Hydropack electrical data

POMPA	Potenza nominale [kW]	Corrente assorbita nominale [A]
1P1SBV 45.4-60.4 EXC/PRM	1,5	3,17
1P1SBV 65.4-90.4 EXC / 65.4-85.4 PRM	2,2	4,56
1P1SBV 90.4 PRM	3,0	6,33

Accessories - Hydronic assembly

1P1SBV - User side Hydropack with 1 inverter pump and 1 stand-by pump with dedicated inverter

Head - Size 45.4 - 60.4 EXC/PRM

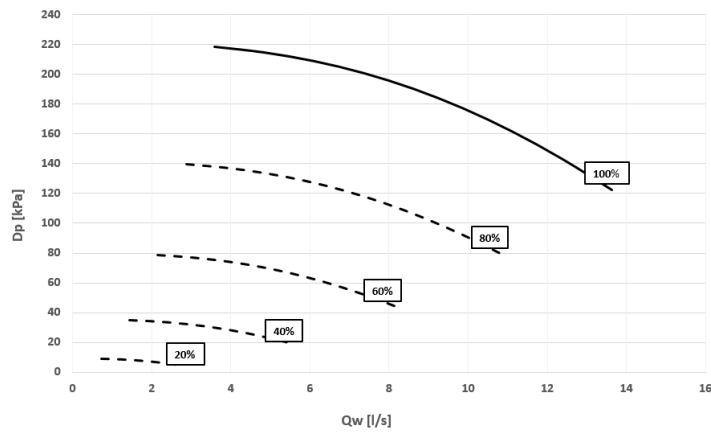

Dp = Pump head [kPa]
QW = Water flow-rate [l/s]

Power input - Size 45.4 - 60.4 EXC/PRM

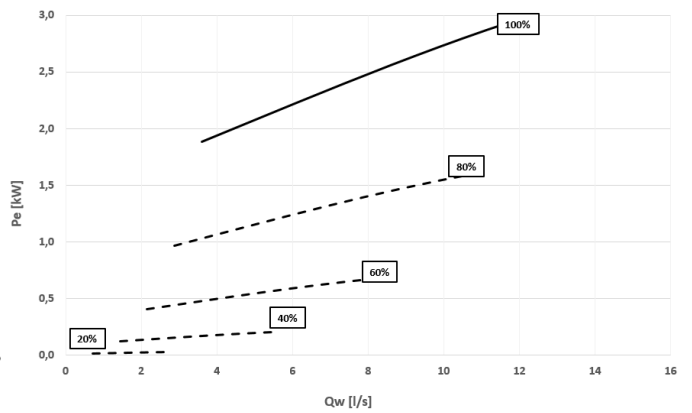

Pe = Power input [kW]
QW = Water flow-rate [l/s]

Head - Size 65.4 - 90.4 EXC / 65.4-85.4 PRM

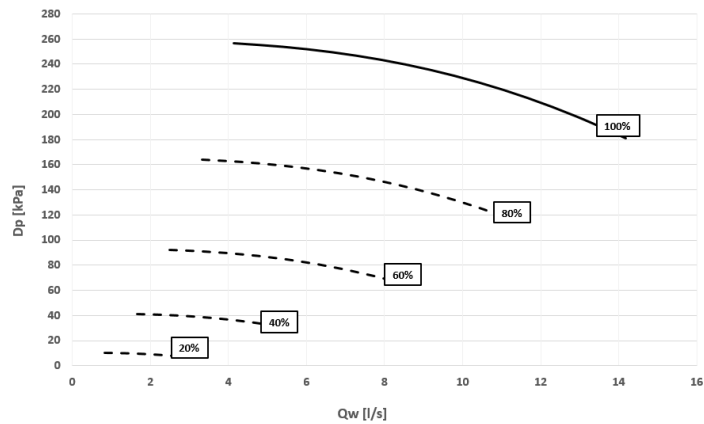

Dp = Pump head [kPa]
QW = Water flow-rate [l/s]

Power input - Size 65.4 - 90.4 EXC / 65.4-85.4 PRM

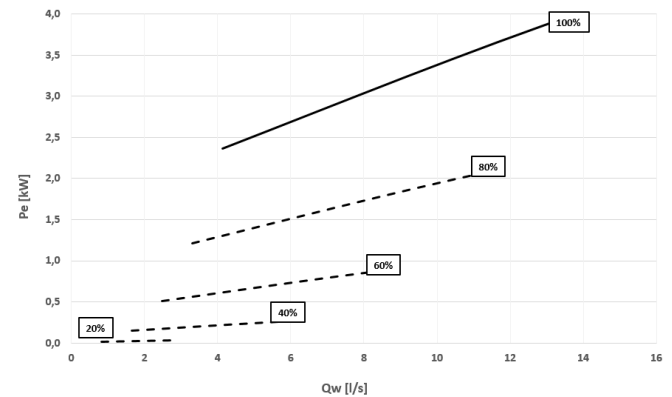

Pe = Power input [kW]
QW = Water flow-rate [l/s]

Head - Size 90.4 PRM

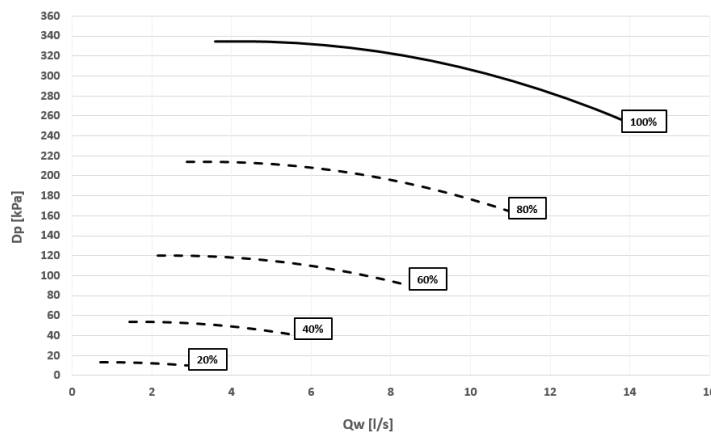

Dp = Pump head [kPa]
QW = Water flow-rate [l/s]

Assorbimento - Size 90.4 PRM

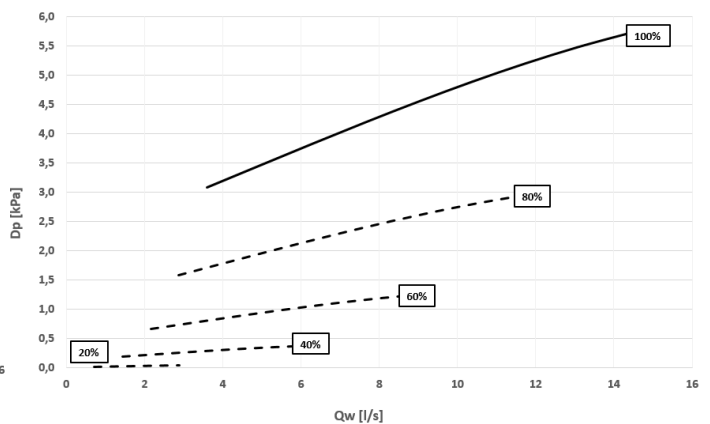

Pe = Power input [kW]
QW = Water flow-rate [l/s]

1PAPSV - User side Hydropack with 1 high head inverter pump and 1 standby pump with dedicated inverter

Pumping group consisting of 1+1 electric pump (1 stand-by) controlled by inverter to adapt to different conditions of use.

It enables the automatic reduction of the liquid flow-rate in critical conditions, avoiding blocks due to overloading and consequential intervention work by specialised technical personnel.

Through the inverter calibration, standard supplied, it is possible to adapt the pump flow-rate/head to the installation feature.

Centrifugal electric pump with the pump body made of cast iron and the impeller made stainless steel or cast iron (depending on the models)

Mechanical seal using ceramic, carbon and EPDM elastomer components.

Three-phase electric motor with IP55 protection rating. Complete with thermoformed insulating casing, quick-release couplings with an insulated casing, safety valve, pressure gauges, system load safety pressure switch, stainless steel immersion antifreeze heaters fitted on the suction and supply lines.

In combination with the "IVFDT" - Variable flow-rate control option, it allows variation of the water flow-rate to the system under partial-load to achieve the highest unit efficiency and lower consumption of the pumping group.

All water fittings are Victaulic.

Option supplied on the unit.

CONNECTION DIAGRAM 1PAPSV - Group with 1 high head inverter pump and 1 standby pump with dedicated inverter

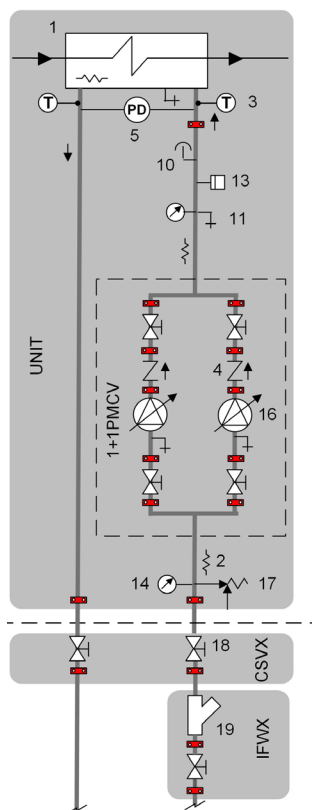

1. Exchanger
2. Antifreeze heater
3. Water temperature probe
4. Non-return valve
5. Differential pressure switch
10. Vent
11. Drain
13. System load safety pressure switch
14. Pressure gauge
16. Packaged electric pump with high efficiency impeller
17. Safety valve
18. Shut-off valve
19. Filter

T - Temperature probe
PD - Differential pressure switch

TW in chilled water inlet
TW out chilled water outlet

⚠ Provide hydraulic interceptions outside the unit ('CSVX - Couple of manually operated shut-off valves' option) to facilitate any possible extraordinary maintenance interventions.

⚠ The head and absorption graphs of the hydronic assembly refer to operation with pure water. In the presence of a mixture of water and glycol, please contact Clivet office to check the correct operating point of the hydronic assembly.

Hydropack electrical data

POMPA	Potenza nominale [kW]	Corrente assorbita nominale [A]
1PAPSV 45.4-60.4 EXC/PRM	3,0	6,33
1PAPSV 65.4-90.4 EXC/PRM	4,0	7,62

Accessories - Hydronic assembly

1PAPSV - User side Hydropack with 1 high head inverter pump and 1 standby pump with dedicated inverter

Head - Size 45.4 - 60.4 EXC/PRM

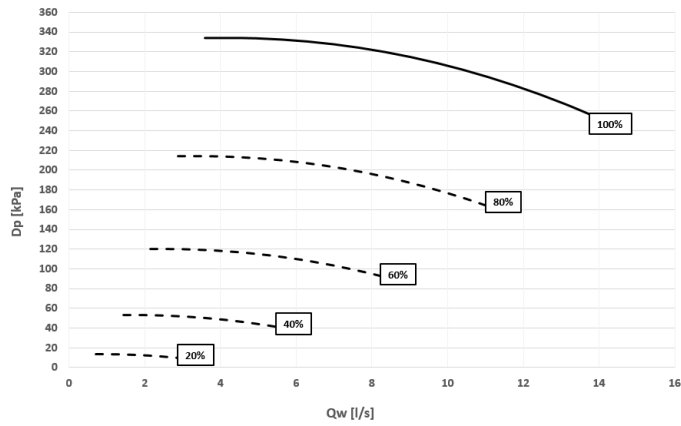

Dp = Pump head [kPa]
Qw = Water flow-rate [l/s]

Power input - Size 45.4 - 60.4 EXC/PRM

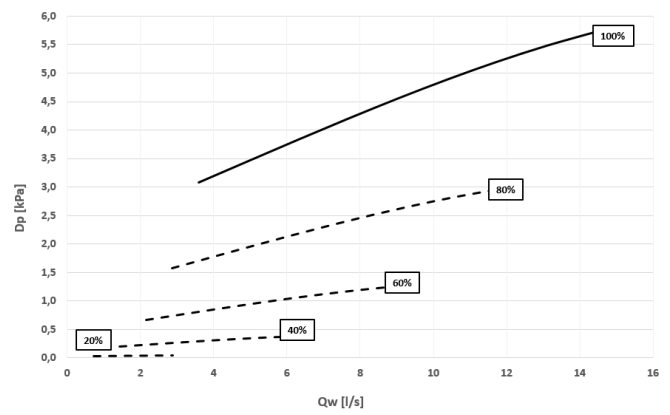

Pe = Power input [kW]
Qw = Water flow-rate [l/s]

Head- Size 65.4 - 90.4 EXC/PRM

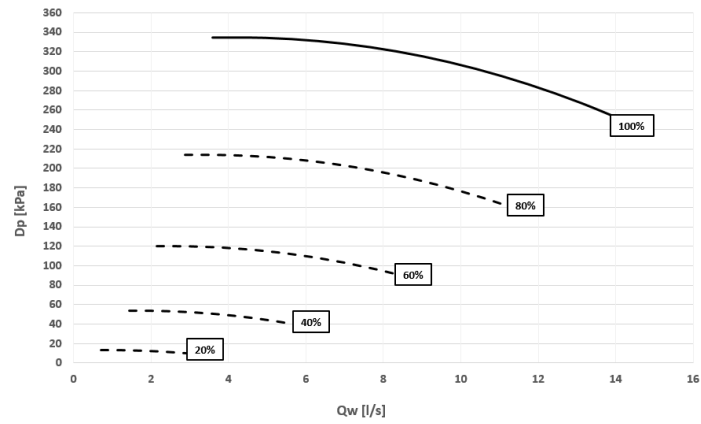

Dp = Pump head [kPa]
Qw = Water flow-rate [l/s]

Power input - Size 65.4 - 90.4 EXC/PRM

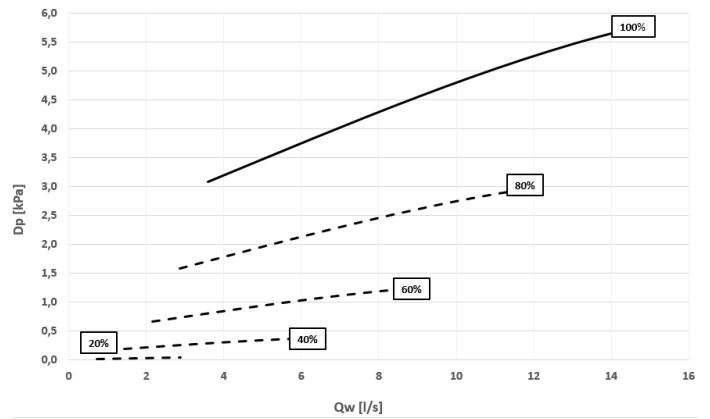

Pe = Power input [kW]
Qw = Water flow-rate [l/s]

User interface (HMI)

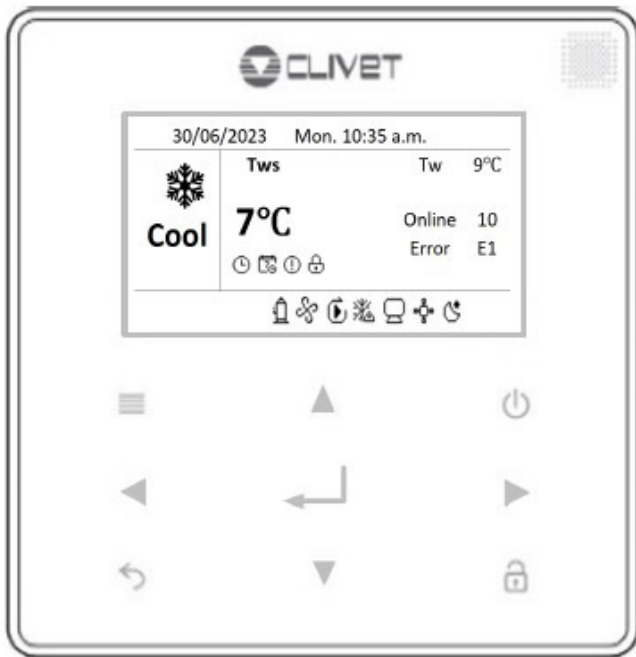

Resolution	1°C	
Temperature sensor	NTC 5k 1%	
Power input	< 1 W	
Storage temperature	-20÷50°C	
Communication	RS485	
Wiring	Type	Cavo schermato
	MAX Length	40 m

The unit is equipped with a user interface (HMI) installed on board, to be used for managing the functions and equipped with an integrated temperature probe.

The user interface comes standard with 22 selectable languages: Italian / English / French / Spanish / Polish / Portuguese / German / Dutch / Romanian / Russian / Turkish / Greek / Swedish / Slovenian / Czech / Slovakian / Bulgarian / Serbian / Danish / Ukrainian / Hungarian / Croatian

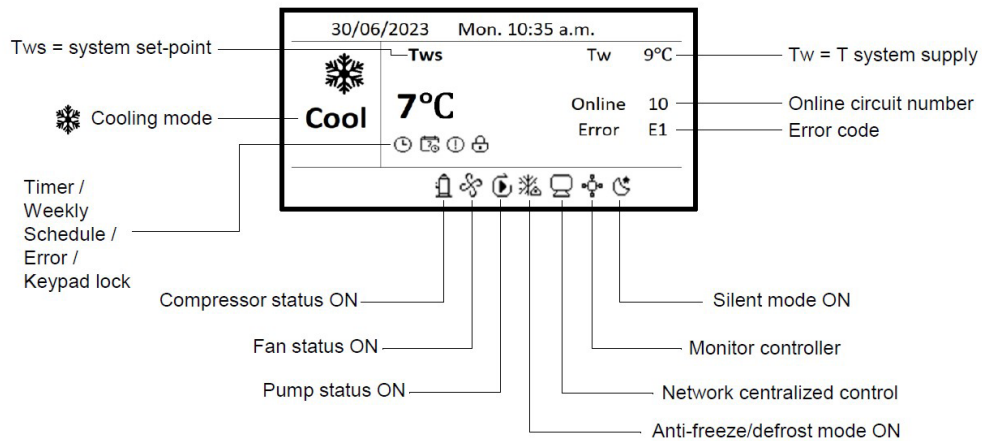

Features and options

Double Set-Point function

It allows to enable the Double setpoint function with HMI. Once enabled, you need to configure the first target water temperature (SetPoint1) and second target water temperature (SetPoint2). At this point the unit detects the closed status of the Double_SP door (normally open). If the contact is open, the unit will operate at the first target water temperature; otherwise, it will operate at the second target temperature.

Set-Point compensation function based on the outside air temperature

Allows to enable the temperature compensation function via HMI. Once the function has been enabled, it is necessary to set:

- The two offset points for the external air temperature (OffsetT4_1 ; OffsetT4_2), which will define the external air temperature field on which the set-point variation will take place;
- The offset point for the water production temperature (OffsetTws) which represents the maximum variation of the set-point allowed. Consequently the unit will update the proportional set-point according to the calculation cycle of the compensation function.

Example of temperature compensation in heating

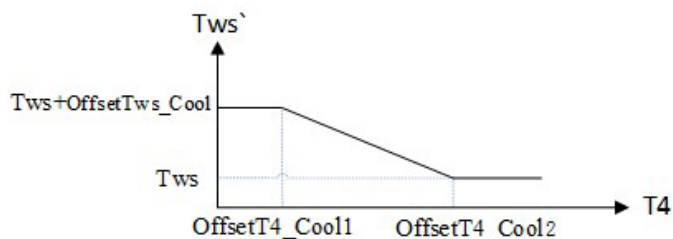

- When the external air temperature (T_4) is lower than the offset one ($T_4 < \text{Offset}T_4_Cool1$) the set-point remains unchanged
- When the external air temperature (T_4) is between the two offset temperatures ($\text{Offset}T_4_Cool1 \leq T_4 < \text{Offset}T_4_Cool2$), the set-point is reduced in direct proportion to the increase in external air temperature.
- - When the ambient temperature (T_4) is higher than the highest offset temperature ($T_4 \geq \text{Offset}T_4_Cool2$), the greater the reduction will be in the set-point temperature.

ENEMON function

Through the HMI it is possible to access the display of the main energy parameters of the displayed circuit and in detail

Power Output = instantaneous power produced in kW

Power Input = instantaneous power absorbed in kW

Current efficiency = instantaneous efficiency represents the EER or the COP

Total energy production is the cumulative energy produced in MWh

The total energy input is the cumulative energy input in MWh

STATE QUERY	
POWER OUTPUT	100 KW
POWER INPUT	50 KW
CURRENT EFFICIENCY	2
TOTAL ENERGY OUTPUT	10 MWh
TOTAL ENERGY INPUT	3 MWh
BACK	2/2 ▲▼ ◀▶

All energy meter display items are available via Modbus, on addresses from $232 + (\text{Circuit adress}) * 100$ a $236 + (\text{Circuit adress}) * 100$.

SILENT function

The function allows to select up to four acoustic modes, for maximum sound configurability of the units. For three of these modes, Standard, Silent and Supersilent, the heating/cooling capacity, efficiencies and sound levels of all sizes are shown in the general technical data section of the bulletin, as well as on the navigator.

The Night Mode configuration, on the other hand, allows for a further reduction in the sound level of up to 3 dB(A) compared to the supersilent mode, for an even lower acoustic impact of the unit.

To select the mode of interest, simply set it from the HMI through the User menu as shown in the following screen.

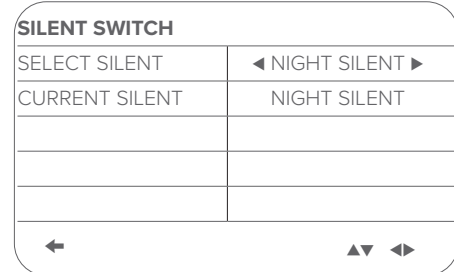

Smart Grid & EVU functions (REMAU option required)

The unit is certified Smart Grid Ready and is equipped with logic for connection to devices that balance the loads connected to the electric grid and optimize general electricity consumption. The connection is optional, the function can be enabled from the REMAU and is linked to the ON/OFF SG input, which receives a status signal from the electrical network.

The control logic of the SG and EVU contacts is as follows:

CONTACT		OPERATION
SG	EVU	SYSTEM
ON	ON	ON forced
OFF	ON	OFF forced
OFF	OFF	Standard
ON	OFF	Standard

Features and options

Modularity

Many applications require drives to be installed as back-up to the main system or have loads that can change significantly during annual operation.

Through this function, without the aid of further accessories, it is possible to operate with up to 8 units hydraulically connected in parallel. From the user interface of the unit defined as Master, the other units are electrically connected in series through the dedicated terminals P, Q and E. Each connected module is identified by an address, from 0 to 15: the Master unit is identified as 0. Complete control of the system (including ancillary elements such as external pumping system and auxiliary heater) is handled by the Master unit.

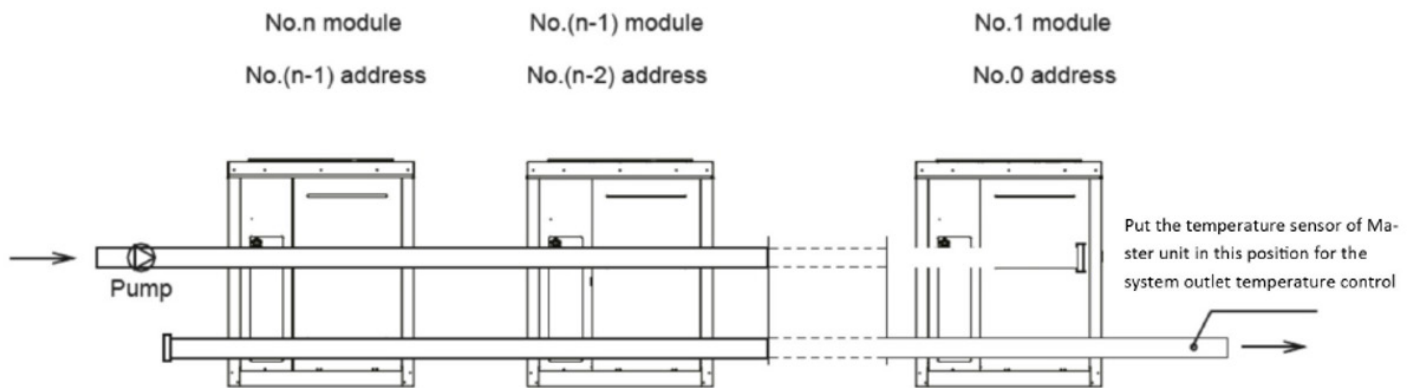

Operation

The master unit calculates the required cooling capacity of the system based on the water supply temperature and the temperature set-point. Instead, each individual unit calculates its required cooling capacity based on the supply and return temperatures. The units are activated according to the last in first out logic (the first unit to be activated will be the last to be deactivated) and is shown in the two figures below.

- T_w = Water supply temperature
- T_{ws} = Water supply temperature set-point

Cooling mode

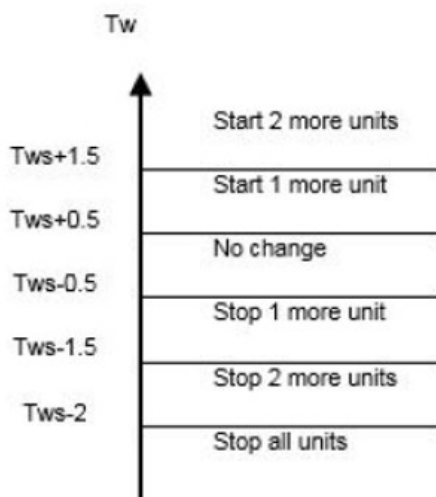

In cooling mode, if $T_w \geq T_{ws} - 10^\circ\text{C}$ 50% of the system units are activated.

After having satisfied the system load and having deactivated the units, at the next start-up the first unit to have been deactivated will be the first to be started, in order to guarantee the correct balancing of the operating hours.

SIZE 45.4 ÷ 55.4 - EXC/PRM

DAAJ40000_00
DATA/DATE 21/10/2022

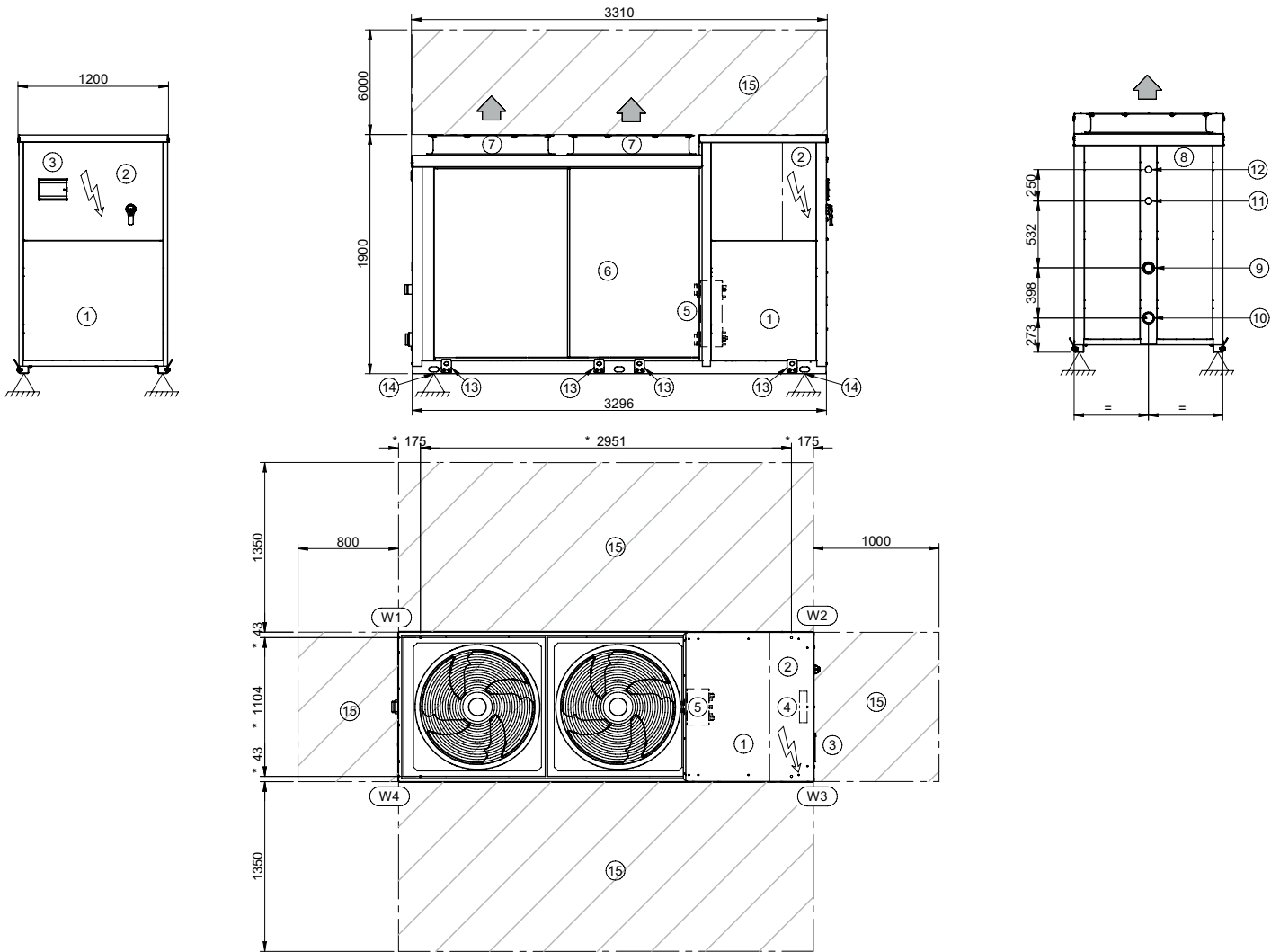

1. Compressor enclosure
2. Electrical panel
3. Control keypad
4. Power input
5. Internal exchanger
6. External exchanger
7. Fan
8. Rear enclosure
9. Inlet water connection 2" 1/2
10. Outlet water connection 2" 1/2

11. Partial recovery inlet water connection 1" 1/4 gas
 12. Partial recovery outlet water connection 1" 1/4 gas
 13. Lifting bracket (removed)
 14. Supporting point
 15. Functional spaces
- * Position of antivibration mounts

SIZE		45.4	50.4	55.4	60.4
Length	mm	3310	3310	3310	3310
Depth	mm	1200	1200	1200	1200
Height	mm	1900	1900	1900	1900
W1 Supporting point	kg	258	258	258	351
W2 Supporting point	kg	411	411	411	562
W3 Supporting point	kg	411	411	411	562
W4 Supporting point	kg	258	258	258	351
Operating weight	kg	1337	1337	1337	1826
Shipping weight	kg	1322	1322	1322	1795

Dimensional drawings

SIZE 60.4 ÷ 90.4 - EXC/PRM

DAAJ40001_00
DATA/DATE 21/10/2022

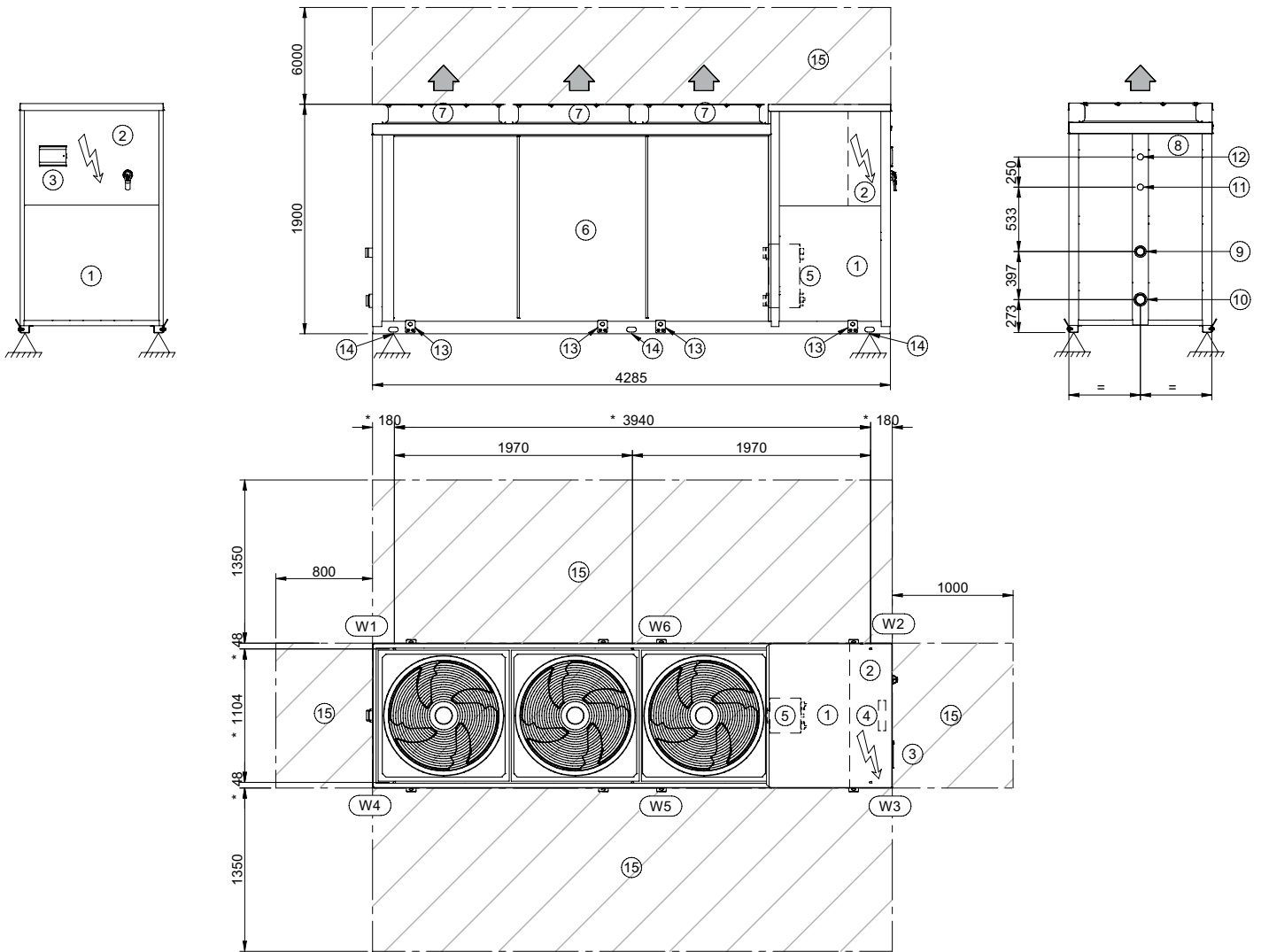

1. Compressor enclosure
2. Electrical panel
3. Control keypad
4. Power input
5. Internal exchanger
6. External exchanger
7. Fan
8. Rear enclosure
9. Inlet water connection 2" 1/2
10. Outlet water connection 2" 1/2

11. Partial recovery inlet water connection 1" 1/4 gas
 12. Partial recovery outlet water connection 1" 1/4 gas
 13. Lifting bracket (removed)
 14. Supporting point
 15. Functional spaces
- * Position of antivibration mounts

SIZE		65.4	70.4	75.4	80.4	85.4	90.4
Length	mm	4300	4300	4300	4300	4300	4300
Depth	mm	1200	1200	1200	1200	1200	1200
Height	mm	1900	1900	1900	1900	1900	1900
W1 Supporting point	kg	351	351	362	362	362	362
W2 Supporting point	kg	562	562	581	581	581	581
W3 Supporting point	kg	562	562	581	581	581	581
W4 Supporting point	kg	351	351	362	362	362	362
Operating weight	kg	1826	1826	1886	1886	1886	1886
Shipping weight	kg	1795	1795	1855	1855	1855	1855

FOR OVER 30 YEARS WE HAVE BEEN OFFERING SOLUTIONS TO ENSURE SUSTAINABLE COMFORT AND THE WELL-BEING OF PEOPLE AND THE ENVIRONMENT

www.clivet.com

MideaGroup
humanizing technology

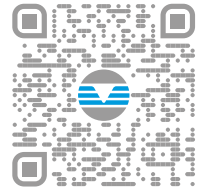

sale and assistance

Valid from: 2024 - (revision 00/2024)
BT24E024GB-00



CLIVET S.p.A.

Via Camp Lonc 25, Z.I. Villapaiera 32032 - Feltre (BL) - Italy
Tel. +39 0439 3131 - info@clivet.it

CLIVET GMBH

Hummelsbütteler Steindamm 84,
22851 Norderstedt, Germany
Tel. +49 40 325957-0 - info.de@clivet.com

Clivet Group UK LTD

Units F5 & F6 Railway Triangle,
Portsmouth, Hampshire PO6 1TG
Tel. +44 02392 381235 -
Enquiries@Clivetgroup.co.uk

CLIVET LLC

Office 508-511, Elektrozavodskaya st. 24,
Moscow, Russian Federation, 107023
Tel. +7495 6462009 - info.ru@clivet.com

CLIVET MIDEAST FZCO

Dubai Silicon Oasis (DSO) Headquarter Building,
Office EG-05, P.O Box-342009, Dubai, UAE
Tel. +9714 3208499 - info@clivet.ae

Clivet South East Europe

Jarušćica 9b
10000, Zagreb, Croatia
Tel. +3851 222 8784 - info.see@clivet.com

CLIVET France

10, rue du Fort de Saint Cyr - 78180 Montigny le
Bretonneux, France
info.fr@clivet.com

Clivet Airconditioning Systems Pvt Ltd

Office No.501 & 502,5th Floor, Commercial -I,
Kohinoor City, Old Premier Compound, Off LBS
Marg, Kiroi Road, Kurla West, Mumbai
Maharashtra 400070, India
Tel. +91 22 30930200 - sales.india@clivet.com